

U16F -36

Compétiteurs/Competitors

#	Nom/Name	Grade	Club	1	G/W	Pts	Pos
1	KAUTZ Seraphine (0,00)	3k	Tsunami Martial Arts Club	XX	0	0	1

Matches/Matches

Match	Blanc/White	Bleu/Blue	Rés/Res	Tmp/Tim	Code
-------	-------------	-----------	---------	---------	------

Résultats/Results

Pos	Nom/Name

U16F -44

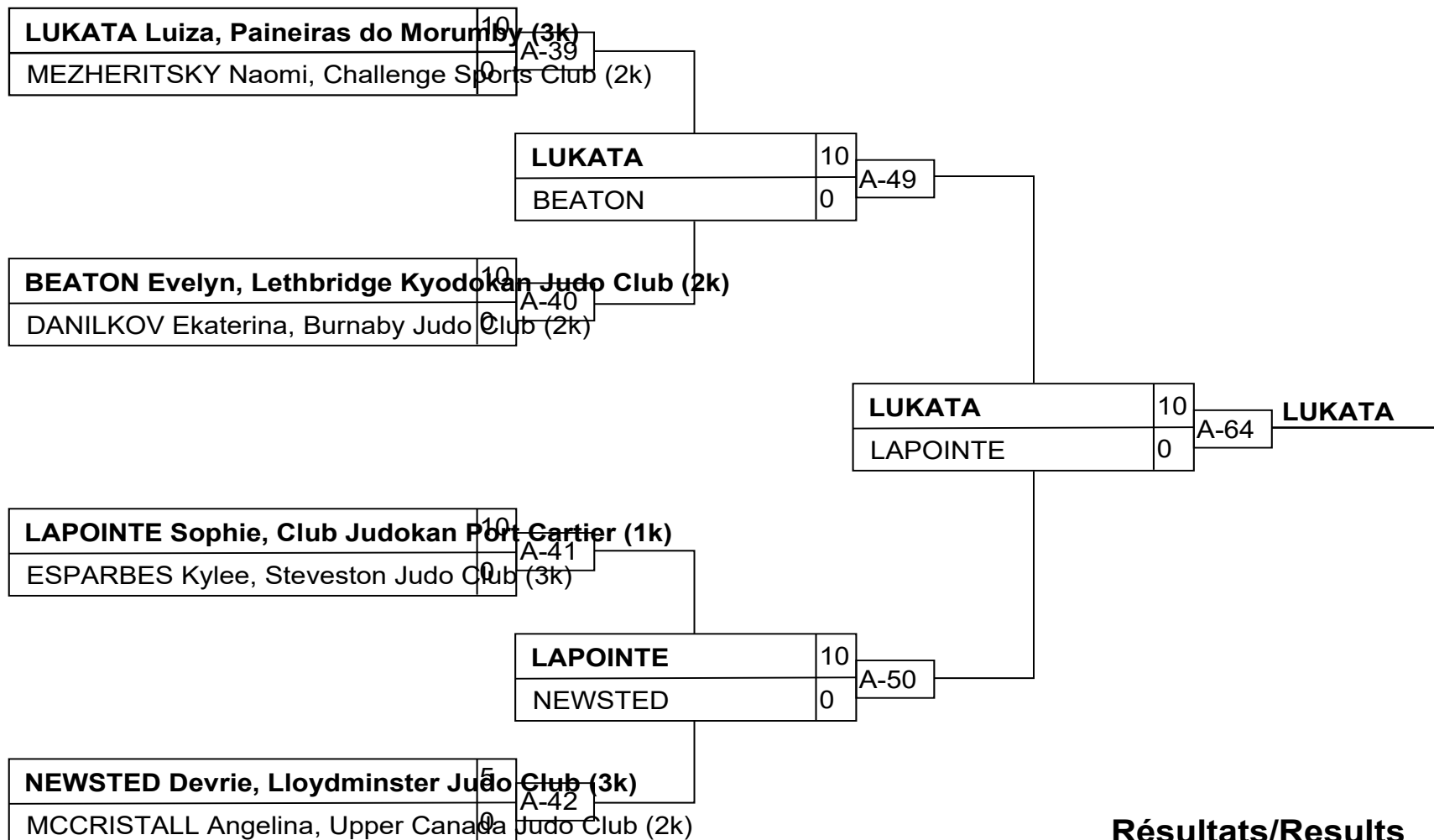

Résultats/Results

Pos	Nom/Name
1	LUKATA Luiza, Paineiras do Morumbi
2	LAPOINTE Sophie, Club Judokan Port
3	BEATON Evelyn, Lethbridge Kyodokan
3	NEWSTED Devrie, Lloydminster Judo

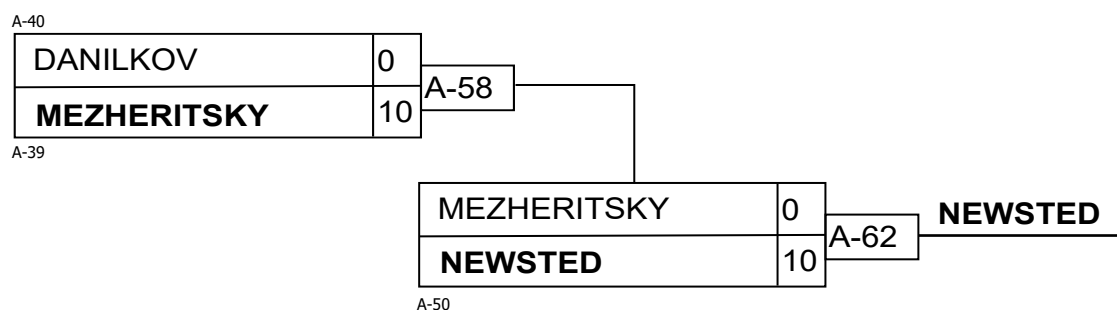
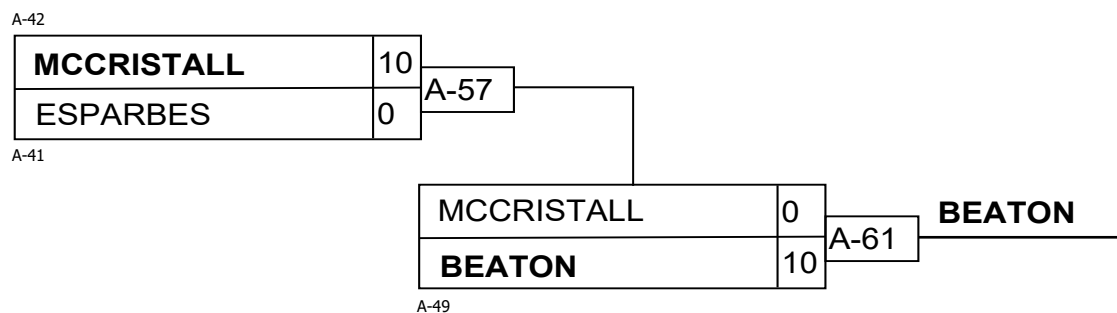

U16F -48

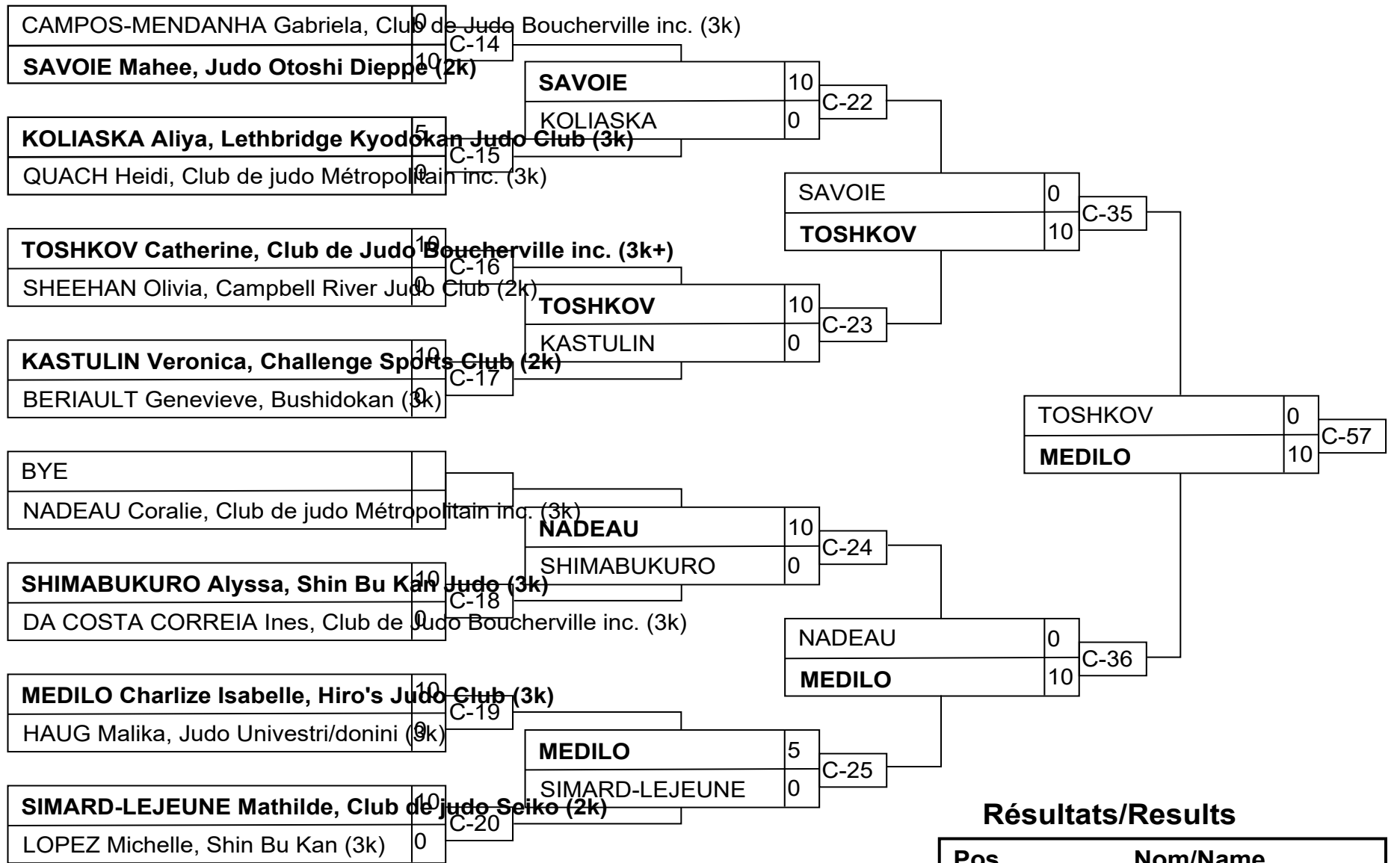

Résultats/Results

Pos	Nom/Name
1	MEDILO Charlize Isabelle, Hiro's Judo Club (3k)
2	TOSHKOV Catherine, Club de Judo Boucherville inc. (3k+)
3	SAVOIE Mahee, Judo Otoshi Dieppe (2k)
3	KASTULIN Veronica, Challenge Sports Club (2k)

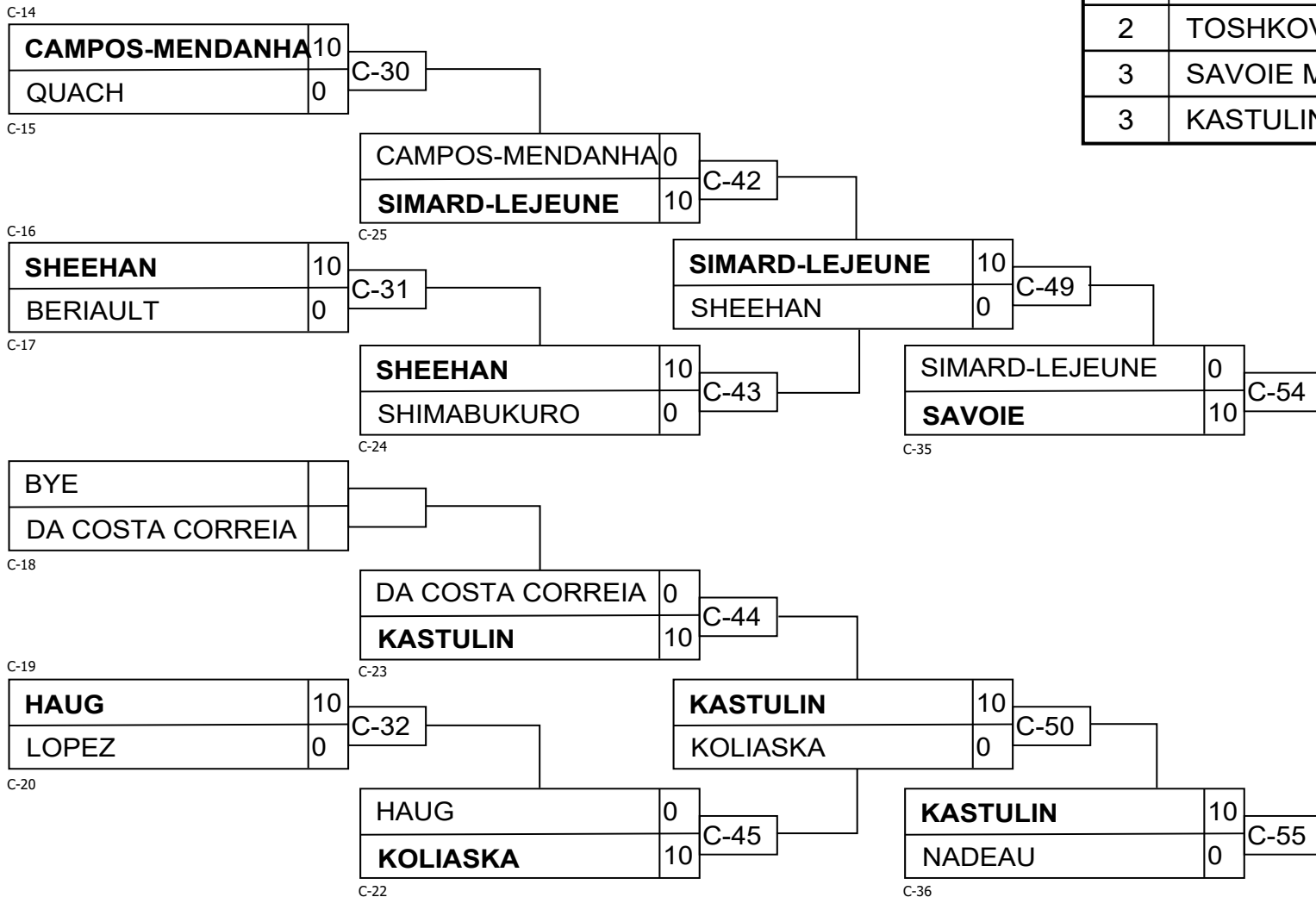

U16F -57

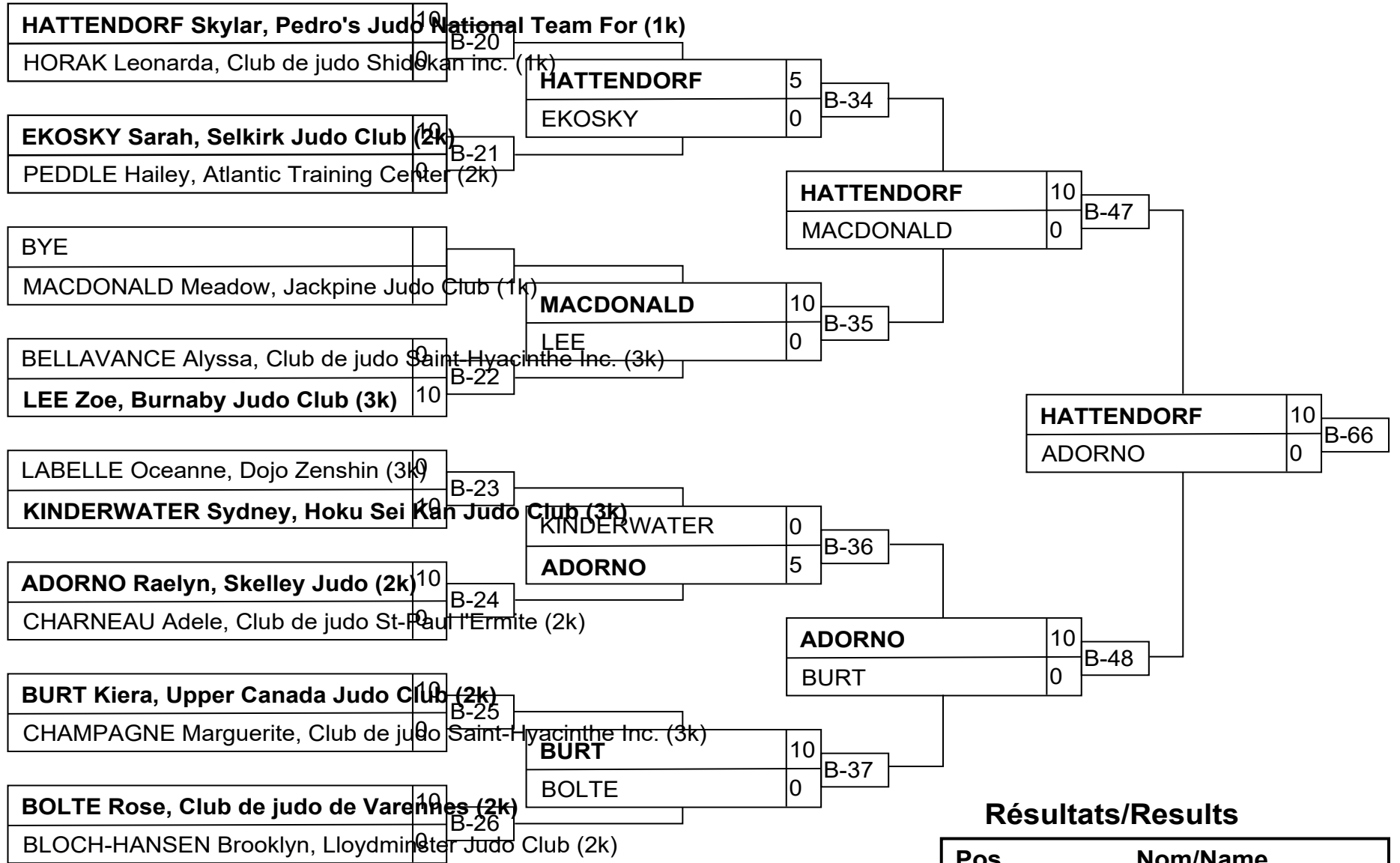

Résultats/Results

Pos	Nom/Name
1	HATTENDORF Skylar, Pedro's Judo N
2	ADORNO Raelyn, Skelley Judo (2k)
3	MACDONALD Meadow, Jackpine Judo
3	BURT Kiera, Upper Canada Judo Club

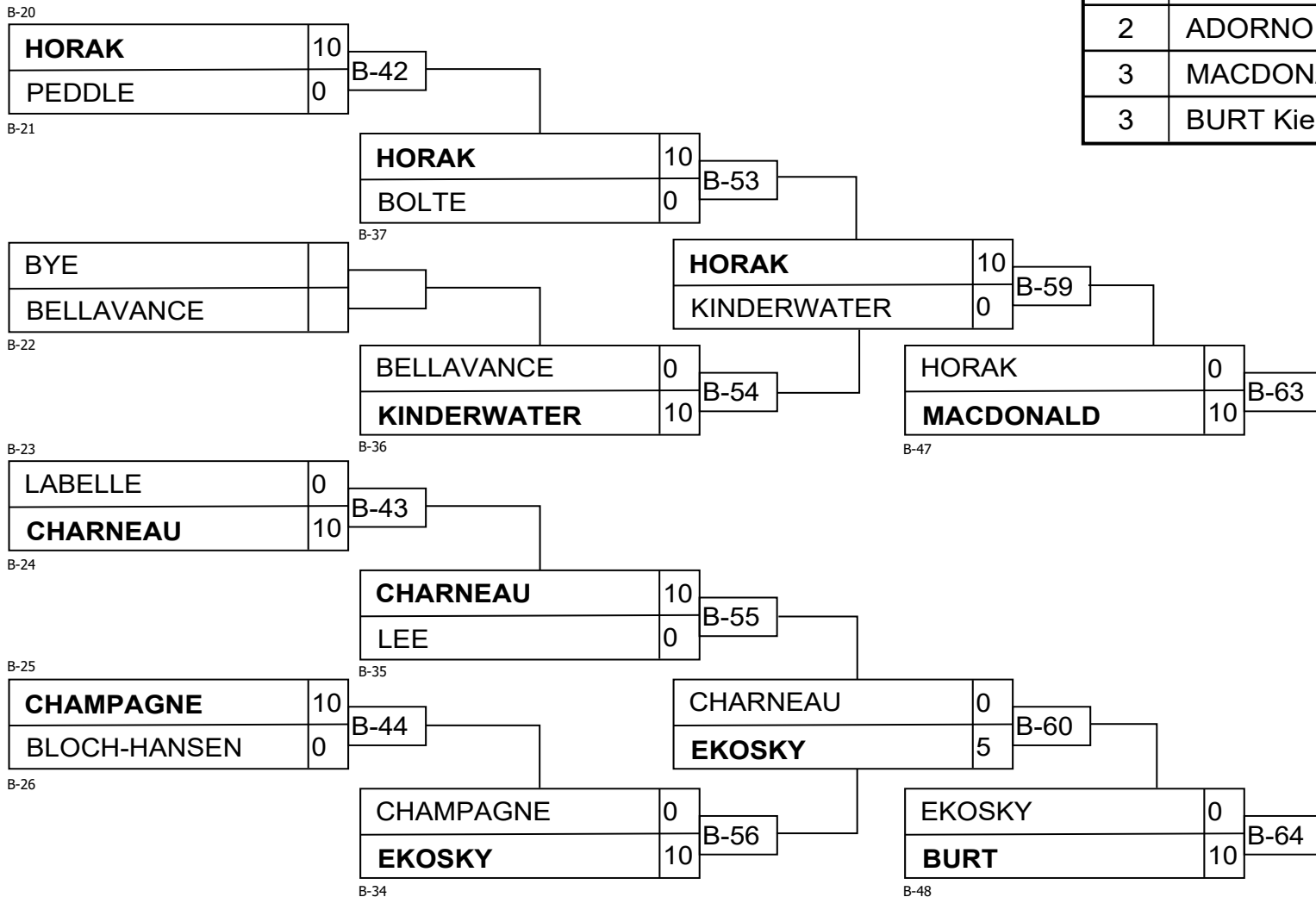

U16F -63

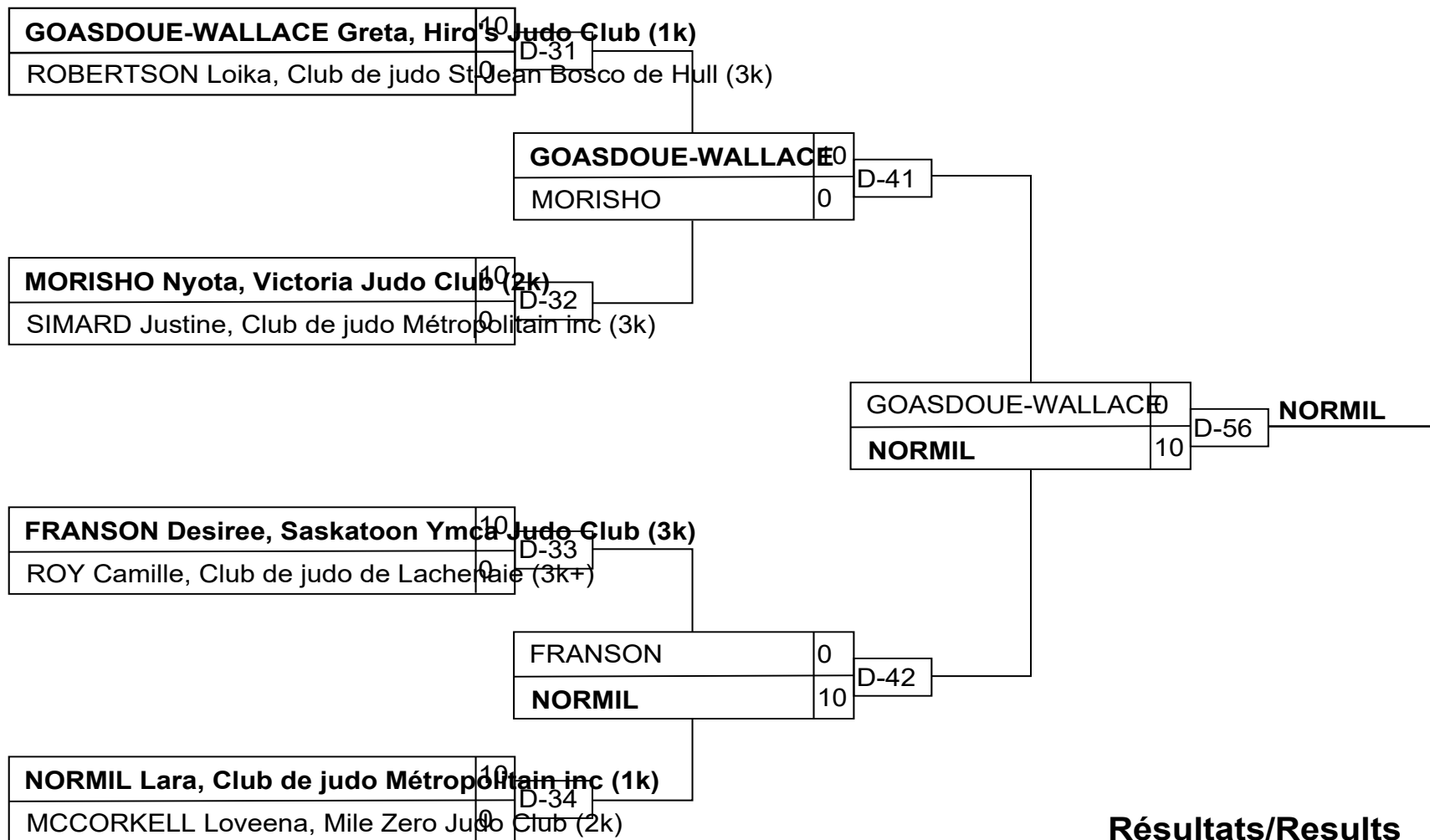

Résultats/Results

Pos	Nom/Name
1	NORMIL Lara, Club de judo Métropolitain inc (1k)
2	GOASDOUE-WALLACE Greta, Hiro' Judo Club (1k)
3	MORISHO Nyota, Victoria Judo Club (2k)
3	ROBERTSON Loika, Club de judo St Jean Bosco de Hull (3k)

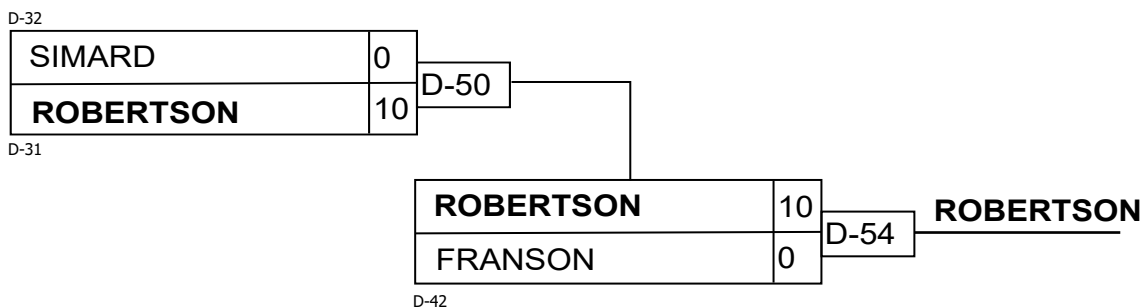
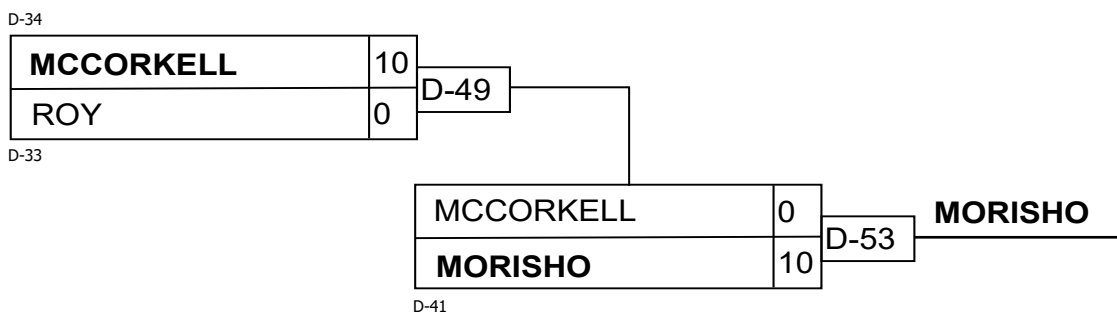

U16F +70

Compétiteurs/Competitors

#	Nom/Name	Grade	Club	1	2	3	G/W	Pts	Pos
1	BOURQUE Kathie (0,00)	3k	Club de judo Ghishintaido	XX			0	0	3
2	LINGLEY Brandi (83,50)	3k+	Tani Koi Judo Club	10	XX		1	10	2
3	DOUGLAS Asia (83,70)	1k	Toronto Judo Kai	10	10	XX	2	20	1

Matches/Matches

Match	Blanc/White			Bleu/Blue	Rés/Res	Tmp/Tim	Code
C-37	BOURQUE Kathie	1	2	LINGLEY Brandi	0 - 10	0:23	WIP
C-46	BOURQUE Kathie	1	3	DOUGLAS Asia	0 - 10	0:08	IPO
C-51	LINGLEY Brandi	2	3	DOUGLAS Asia	0 - 10	0:35	WIP

Résultats/Results

Pos	Nom/Name
1	DOUGLAS Asia, Toronto Judo Kai
2	LINGLEY Brandi, Tani Koi Judo Club

U16M -55

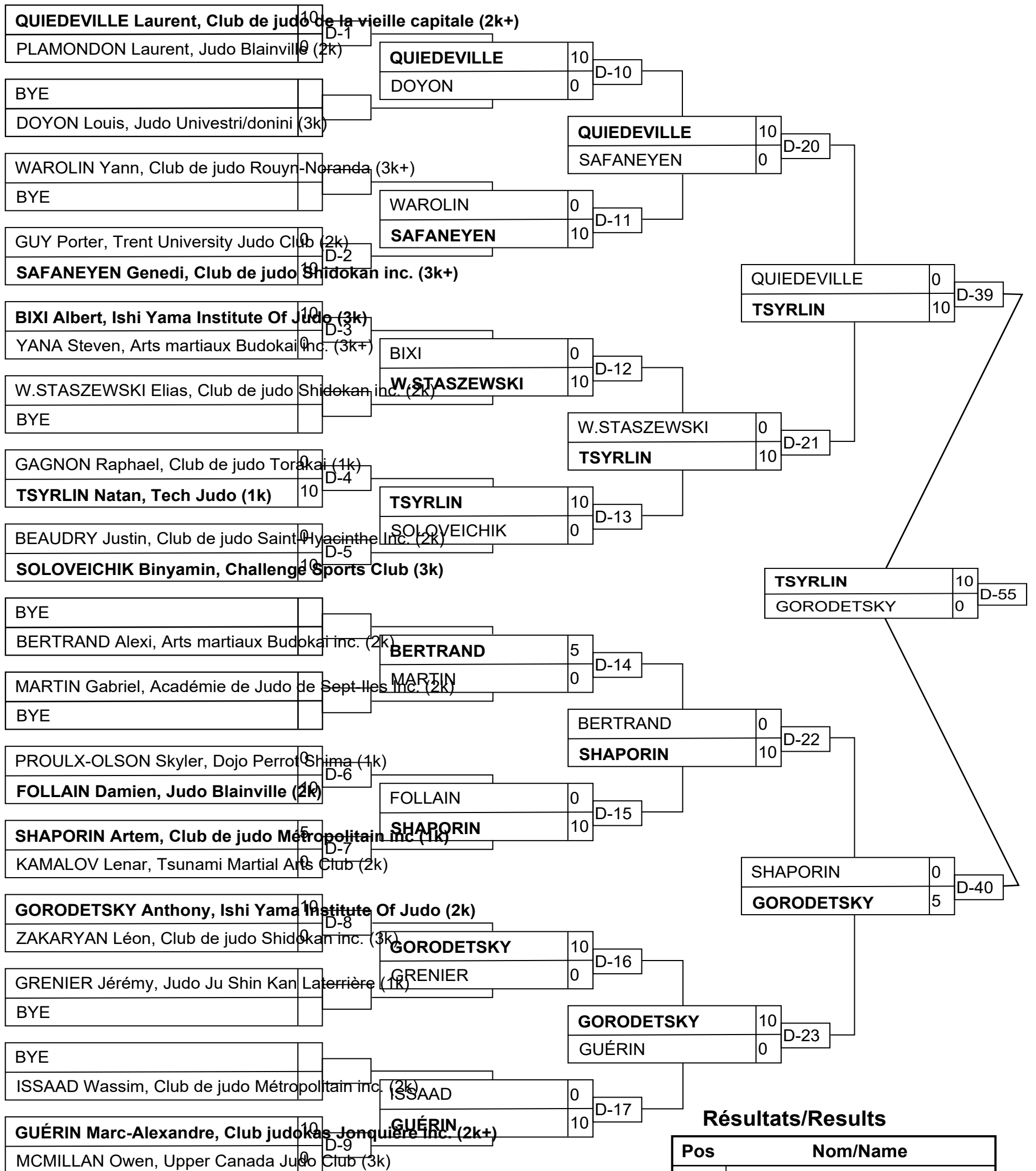

Résultats/Results

Pos	Nom/Name
1	TSYRLIN Natan, Tech Judo (1k)
2	GORODETSKY Anthony, Ishi Yama Institut
3	GUÉRIN Marc-Alexandre, Club judokas Jo
3	SHAPORIN Artem, Club de judo Métropolit

U16M -55

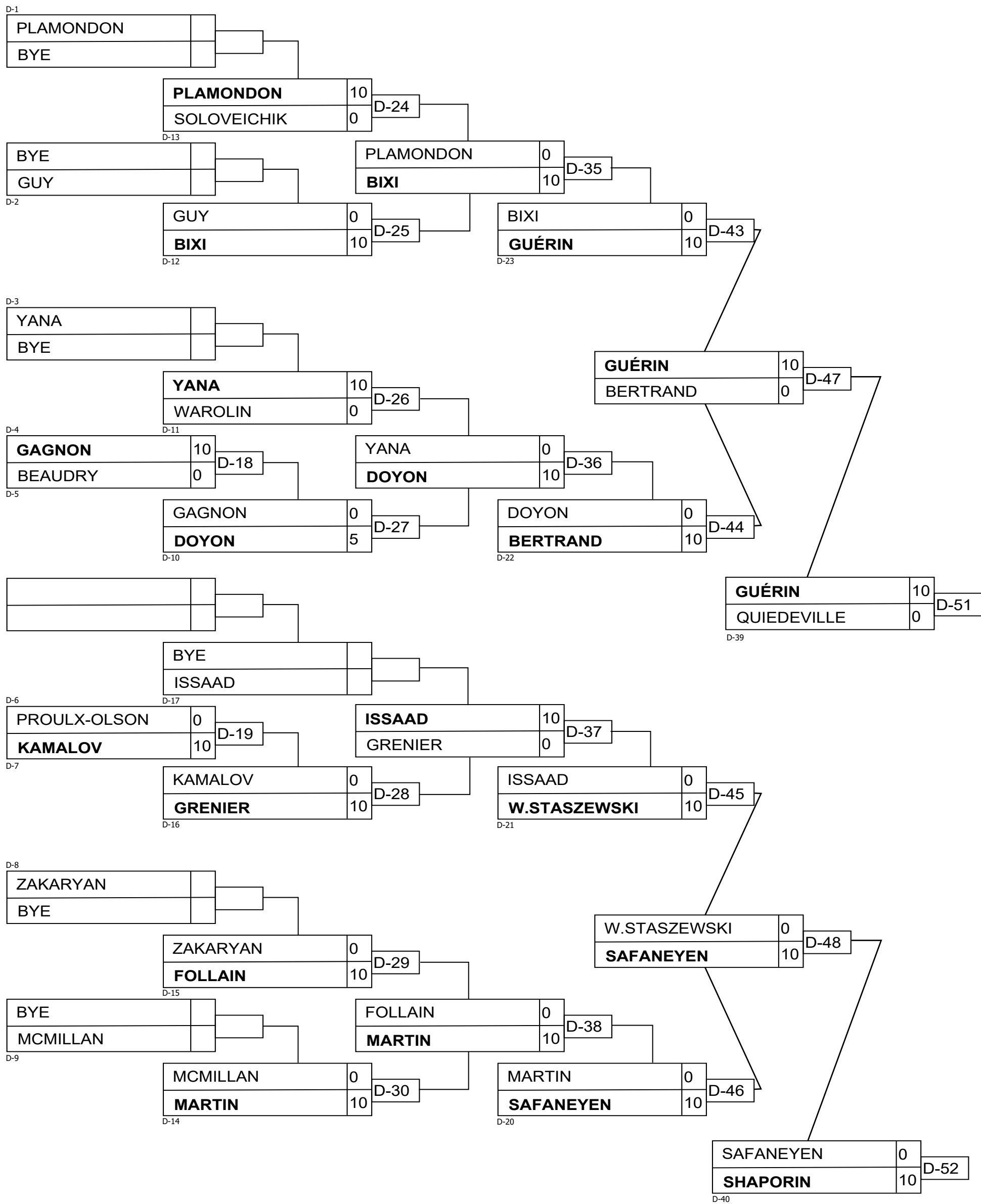

U16M -60

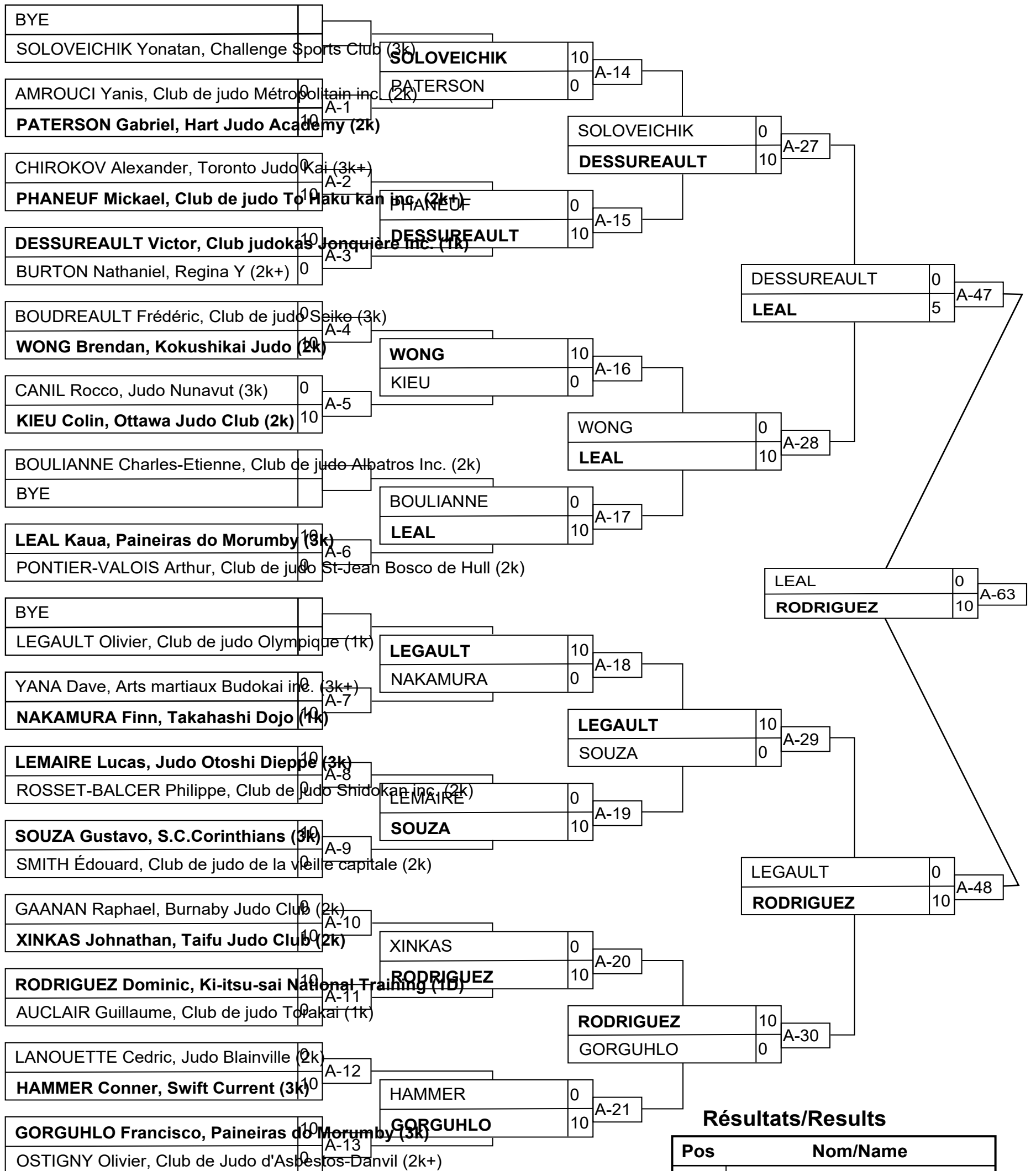

Résultats/Results

Pos	Nom/Name
1	RODRIGUEZ Dominic, Ki-itsu-sai National Training (1k)
2	LEAL Kaua, Paineiras do Morumby (3k)
3	DESSUREAULT Victor, Club judokas Jonquières inc. (1k)
3	LEGAULT Olivier, Club de judo Olympique (1k)

U16M -60

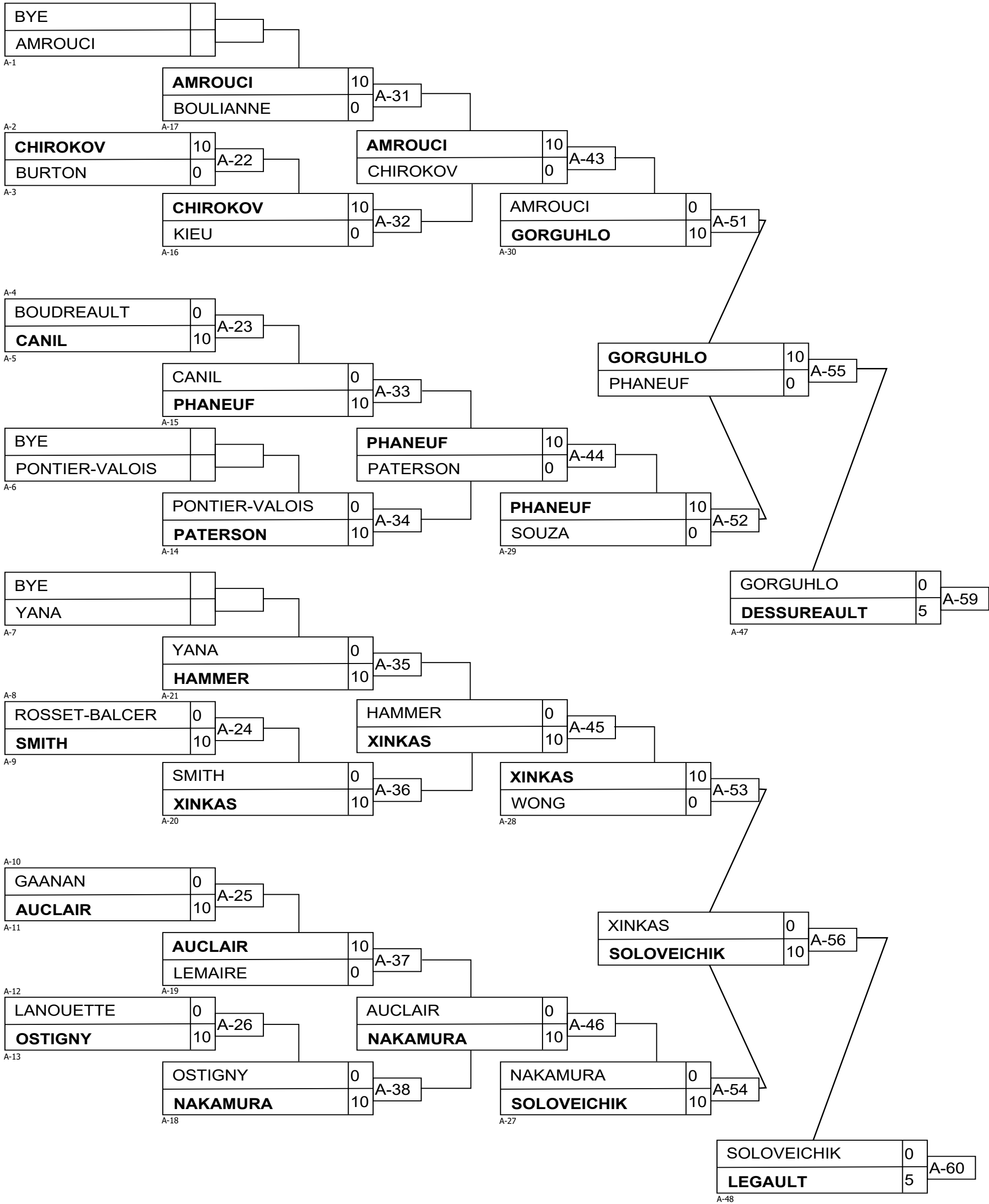

U16M -66

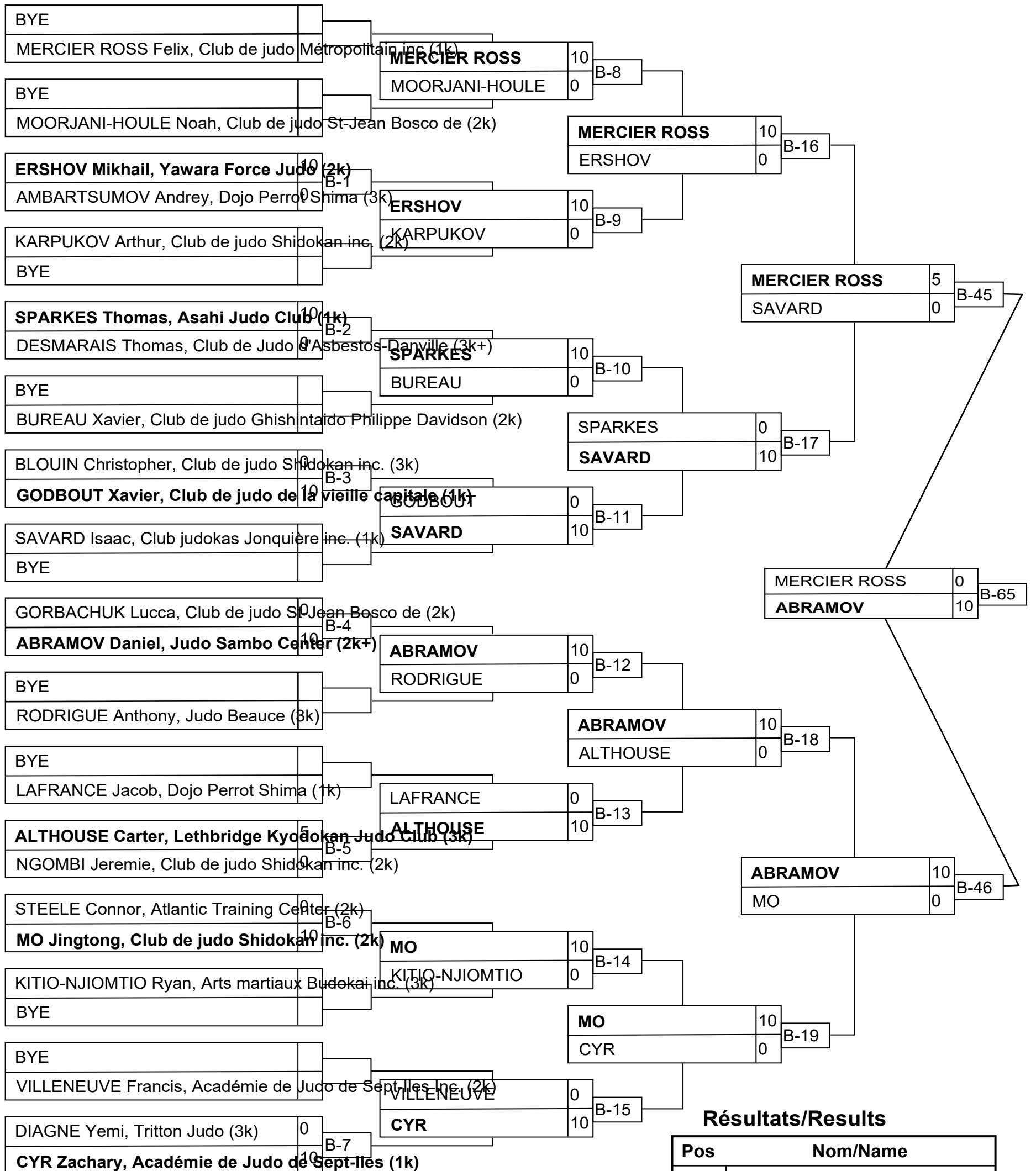

Résultats/Results

Pos	Nom/Name
1	ABRAMOV Daniel, Judo Sambo Center (2k+)
2	MERCIER ROSS Felix, Club de judo Métropolitain inc (1k)
3	KARPUKOV Arthur, Club de judo Shidokan inc. (2k)
3	SPARKES Thomas, Asahi Judo Club (1k)

U16M -66

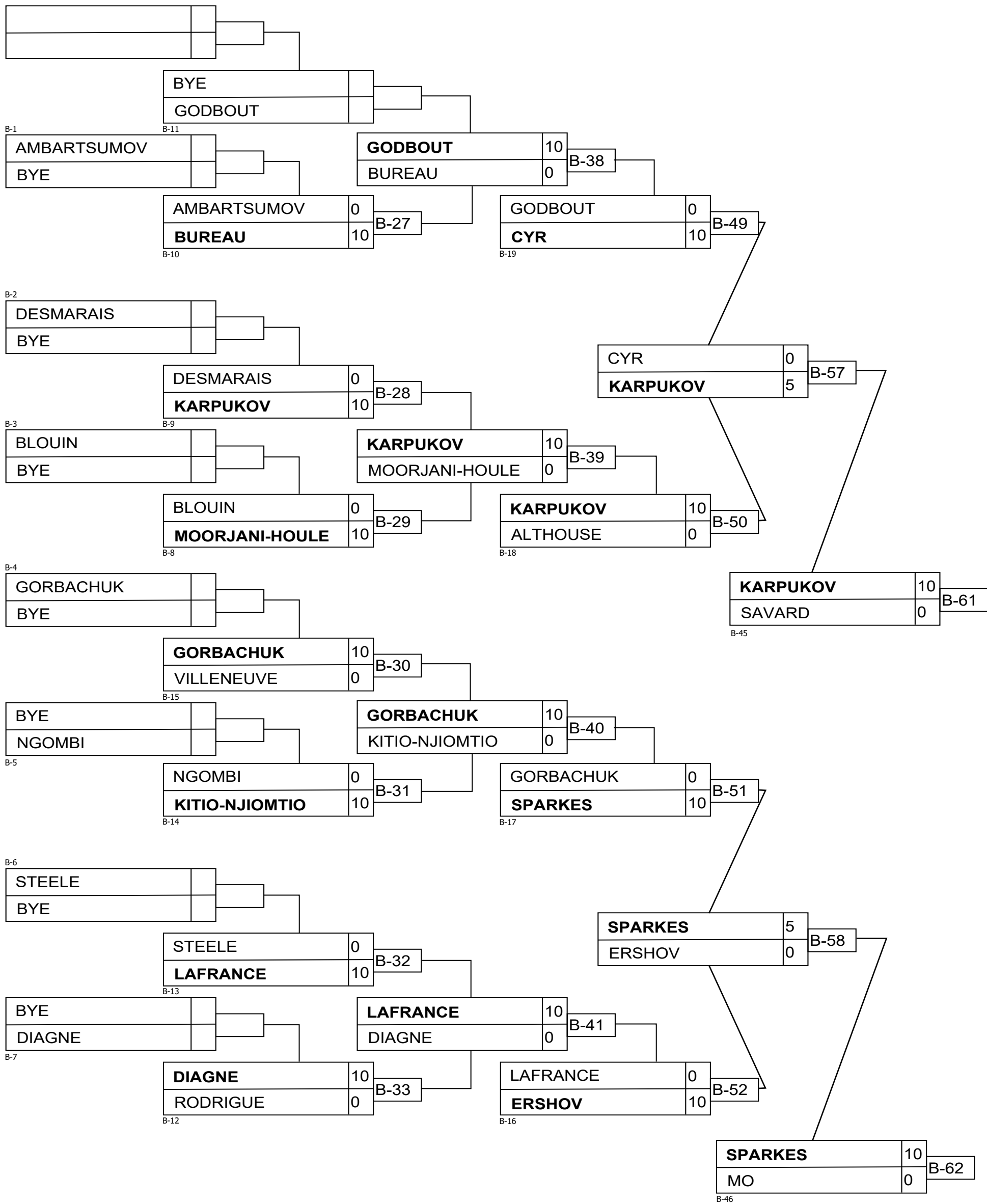

U16M -73

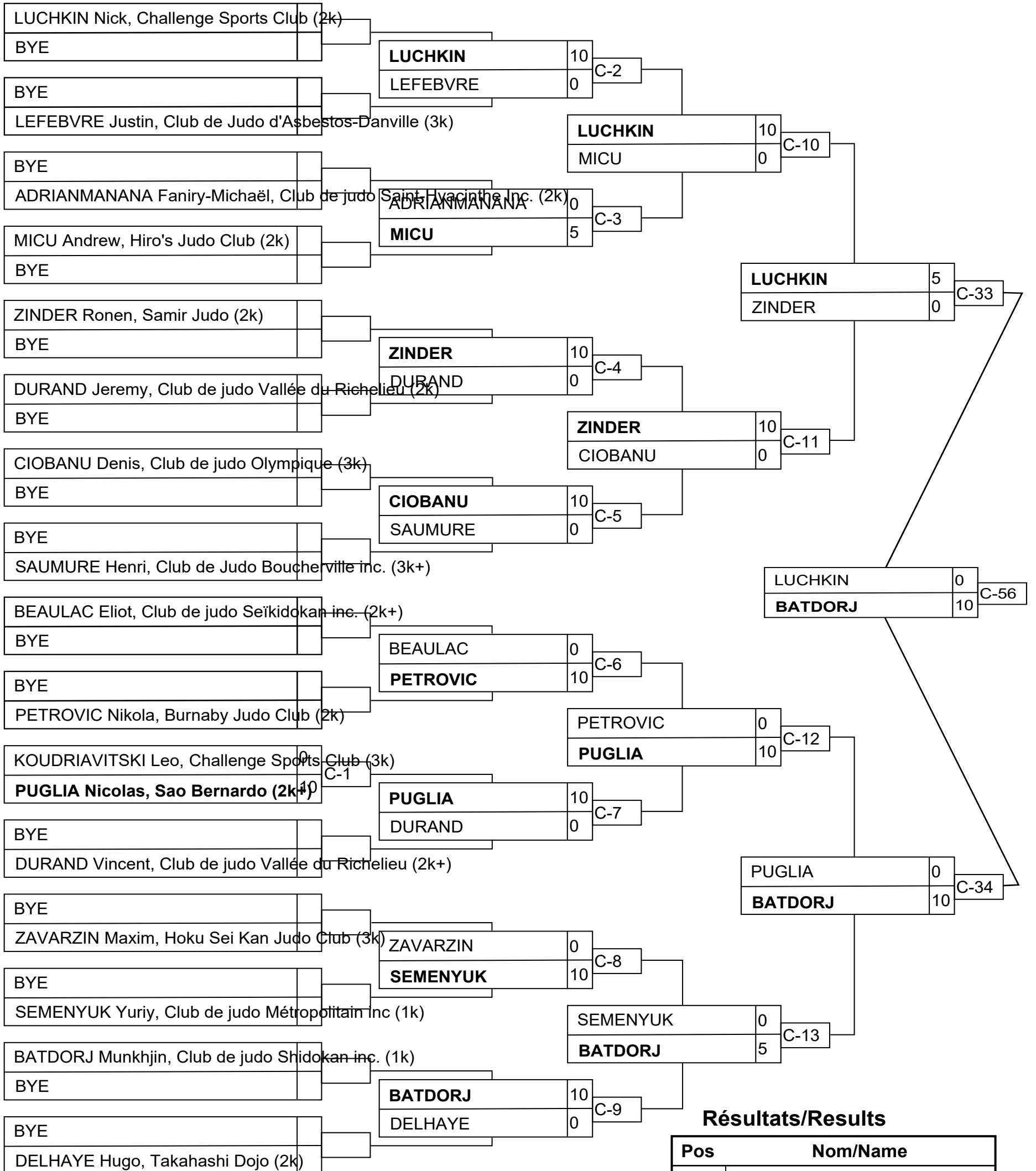

Résultats/Results

Pos	Nom/Name
1	BATDORJ Munkhjin, Club de judo Shidokan inc. (1k)
2	LUCHKIN Nick, Challenge Sports Club (2k)
3	SEMENYUK Yuriy, Club de judo Métropolitain Inc (1k)
3	PUGLIA Nicolas, Sao Bernardo (2k+)

U16M -73

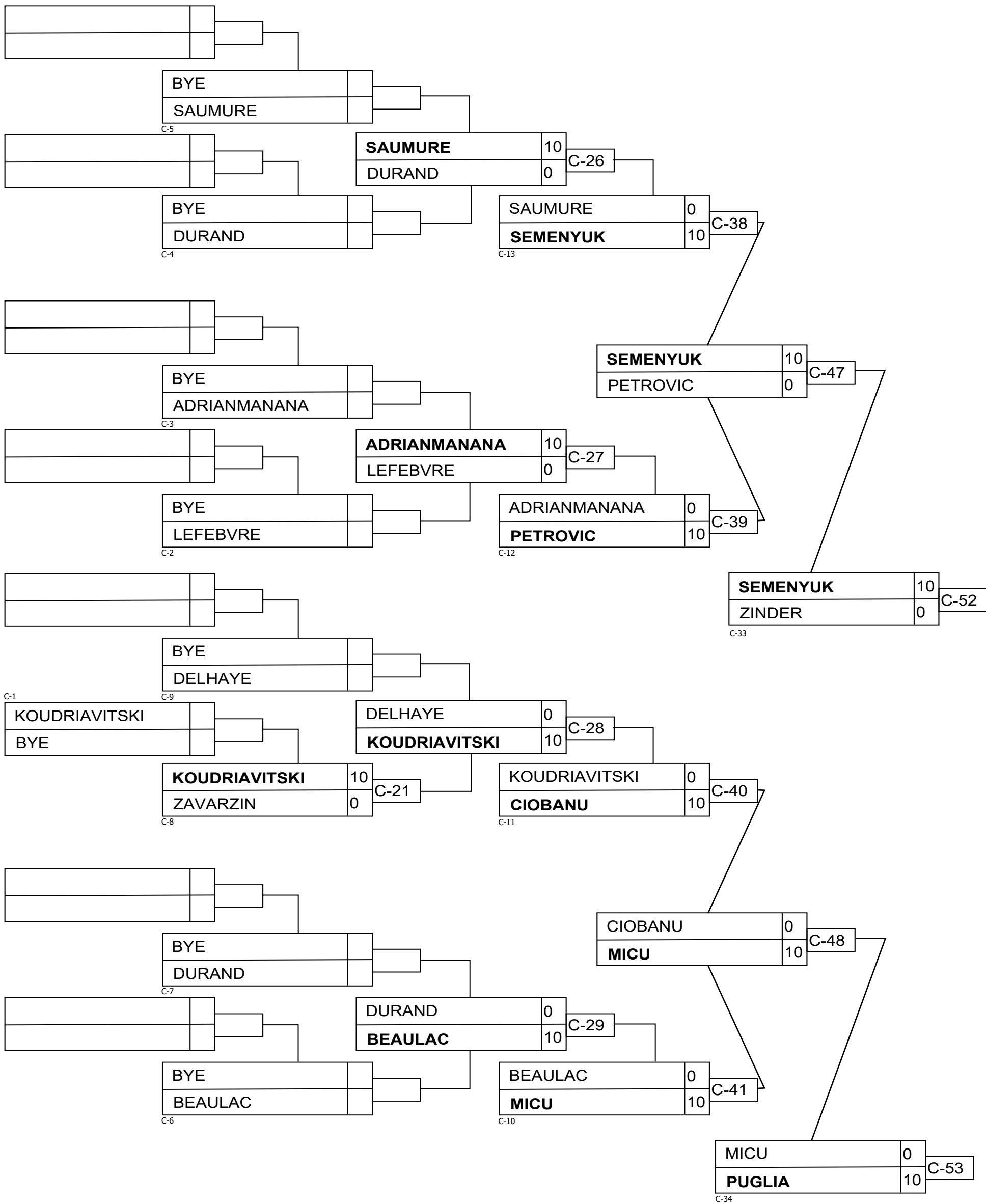

U16F -36

Compétiteurs/Competitors

#	Nom/Name	Grade	Club	1	G/W	Pts	Pos
1	KAUTZ Seraphine (0,00)	3k	Tsunami Martial Arts Club	XX	0	0	1

Matches/Matches

Match	Blanc/White	Bleu/Blue	Rés/Res	Tmp/Tim	Code
-------	-------------	-----------	---------	---------	------

Résultats/Results

Pos	Nom/Name

U16F -40

Compétiteurs/Competitors A

#	Nom/Name	Grade	Club	1	2	3	G/W	Pts	Pos
1	KAUTZ Seraphine (0,00)	3k	Tsunami Martial Arts Club	XX			0	0	3
2	PAUL Marie-Anne (0,00)	3k	Club de judo Torakai	10	XX		1	10	2
3	TURMEL Marie-Lune (0,00)	2k	Académie de judo de Saint-Sauv	10		XX	2	15	1

Matches/Matches A

Match	Blanc/White			Bleu/Blue	Rés/Res	Tmp/Tim	Code
G-39	KAUTZ Seraphine	1	2	PAUL Marie-Anne	0 - 10	1:22	IPO
G-49	KAUTZ Seraphine	1	3	TURMEL Marie-Lune	0 - 5	3:30	GSW
G-55	PAUL Marie-Anne	2	3	TURMEL Marie-Lune	0 - 10	0:32	WIP

Compétiteurs/Competitors B

#	Nom/Name	Grade	Club	4	5	6	G/W	Pts	Pos
4	DUBE Oceane (0,00)	3k	Judo Univestri/donini	XX			0	0	3
5	SHEARER Lola (0,00)	3k	Steveston Judo Club	10	XX		1	10	2
6	IWAASA Brynn (38,00)	3k	Lethbridge Kyodokan Judo Club	10		XX	2	20	1

Matches/Matches B

Match	Blanc/White			Bleu/Blue	Rés/Res	Tmp/Tim	Code
G-40	DUBE Oceane	4	5	SHEARER Lola	0 - 10	1:58	WIP
G-50	DUBE Oceane	4	6	IWAASA Brynn	0 - 10	0:11	IPO
G-56	SHEARER Lola	5	6	IWAASA Brynn	0 - 10	0:12	IPO

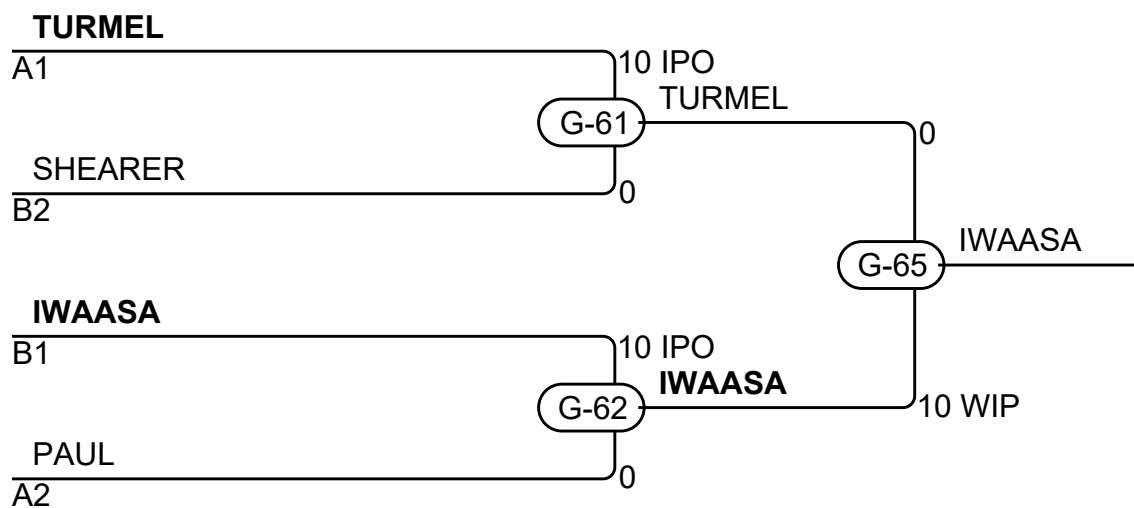

Résultats/Results

Pos	Nom/Name
1	IWAASA Brynn, Lethbridge Kyodokan Judo Club
2	TURMEL Marie-Lune, Académie de judo de Saint-Sauv
3	SHEARER Lola, Steveston Judo Club
3	PAUL Marie-Anne, Club de judo Torakai

U16F -52

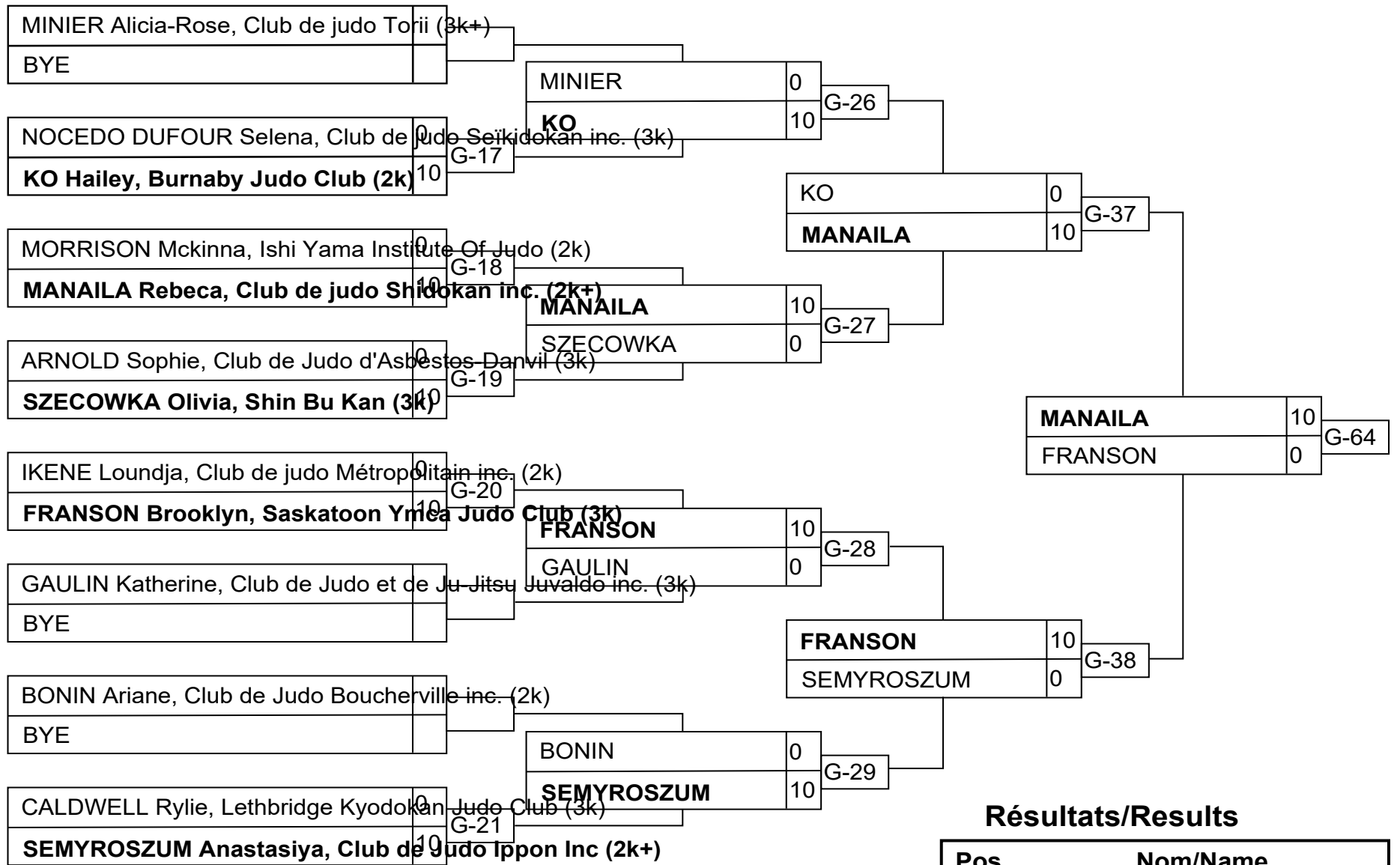

Résultats/Results

Pos	Nom/Name
1	MANAILA Rebeca, Club de judo Shido
2	FRANSON Brooklyn, Saskatoon Ymca
3	KO Hailey, Burnaby Judo Club (2k)
3	SEMYROSZUM Anastasiya, Club de J

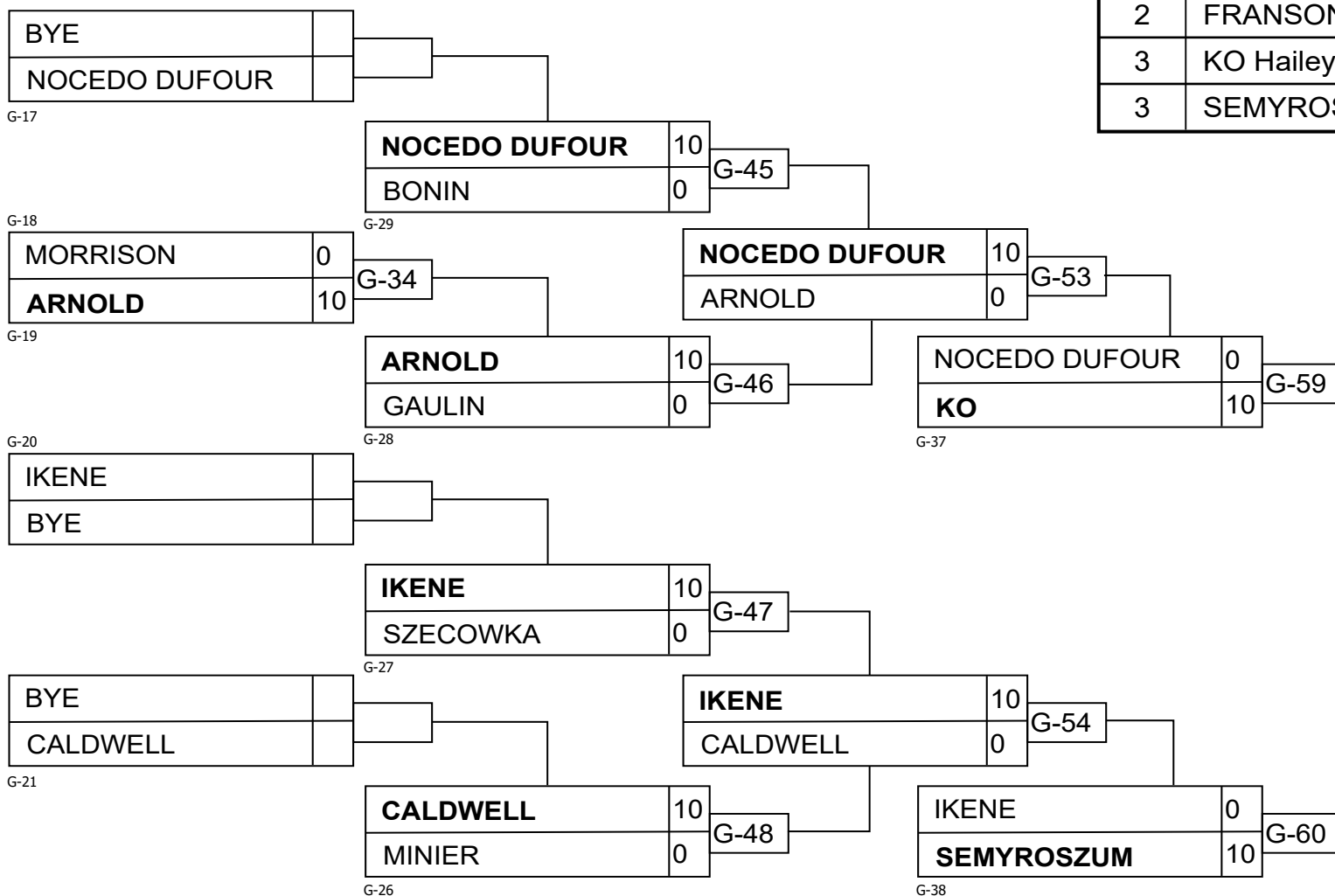

U16F -70

Compétiteurs/Competitors

#	Nom/Name	Grade	Club	1	2	3	4	5	G/W	Pts	Pos
1	SEITZ Mattea (0,00)	3k	Hoku Sei Kan Judo Club	XX		10	10		2	20	3
2	CALDER Mira (67,80)	2k	Kokushikai Judo	10	XX	10	10	5	4	35	1
3	BLAKE Emma (69,20)	1k	Asahi Judo Club			XX			0	0	5
4	GRANT-STUART Divine (0,00)	3k	Shin Bu Kan Judo			10	XX		1	10	4
5	MENENDEZ Arianna (0,00)	1k	Tech Judo	10		10	10	XX	3	30	2

Matches/Matches

Match	Blanc/White			Bleu/Blue	Rés/Res	Tmp/Tim	Code
F-27	GRANT-STUART Divine	4	5	MENENDEZ Arianna	0 - 10	0:43	IPO
F-28	SEITZ Mattea	1	2	CALDER Mira	0 - 10	1:49	IPO
F-37	BLAKE Emma	3	4	GRANT-STUART Divine	0 - 10	0:01	IPO
F-38	SEITZ Mattea	1	5	MENENDEZ Arianna	0 - 10	1:36	IPO
F-43	CALDER Mira	2	3	BLAKE Emma	10 - 0	0:01	FUS
F-44	SEITZ Mattea	1	4	GRANT-STUART Divine	10 - 0	3:00	WIP
F-53	BLAKE Emma	3	5	MENENDEZ Arianna	0 - 10	0:01	FUS
F-54	CALDER Mira	2	4	GRANT-STUART Divine	10 - 0	1:09	IPO
F-59	SEITZ Mattea	1	3	BLAKE Emma	10 - 0	0:01	FUS
F-60	CALDER Mira	2	5	MENENDEZ Arianna	5 - 0	3:00	WAZ

Résultats/Results

Pos	Nom/Name
1	CALDER Mira, Kokushikai Judo
2	MENENDEZ Arianna, Tech Judo
3	SEITZ Mattea, Hoku Sei Kan Judo Club
4	GRANT-STUART Divine, Shin Bu Kan Judo

U16M -38

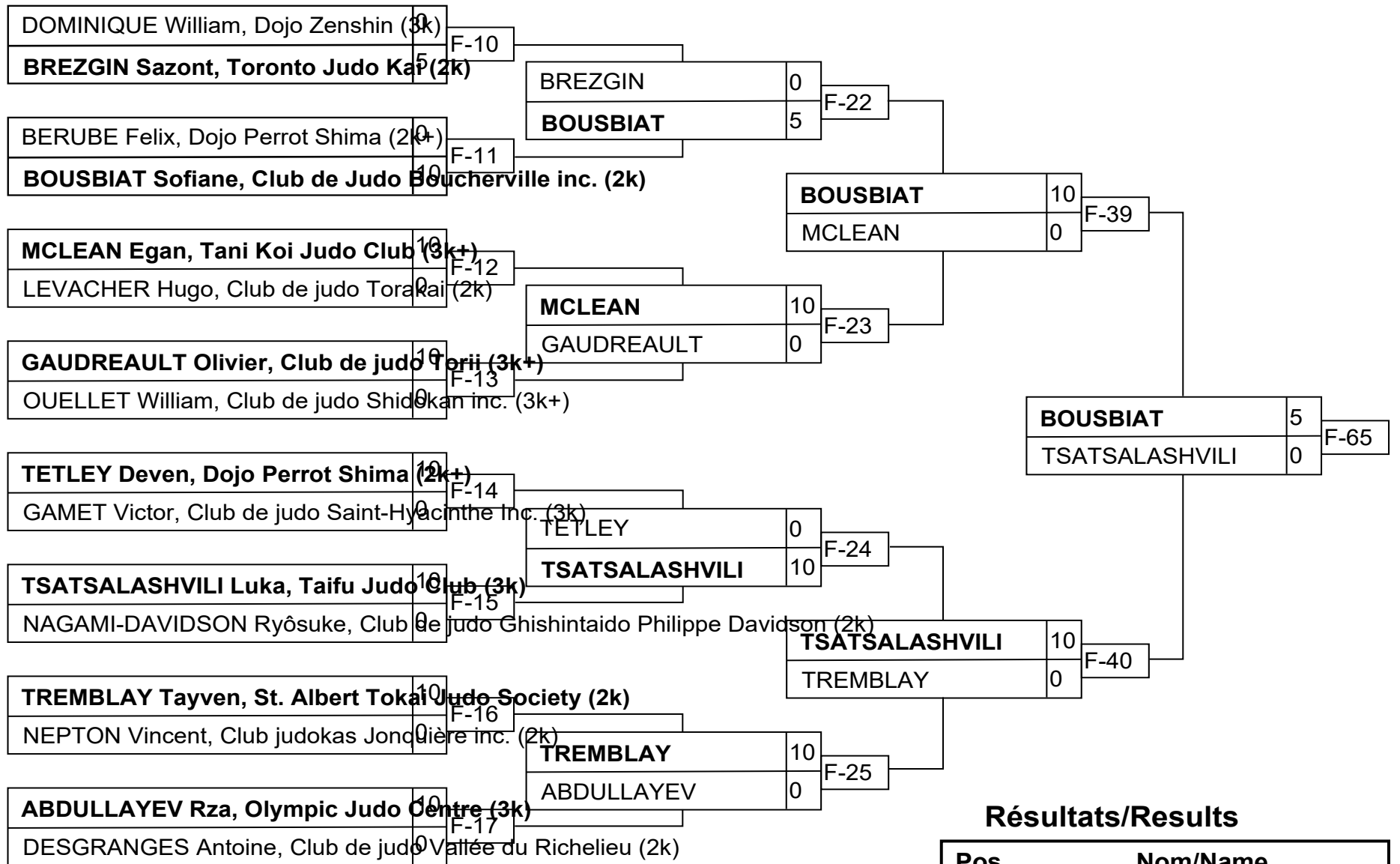

Résultats/Results

Pos	Nom/Name
1	BOUSBIAT Sofiane, Club de Judo Boucheville inc. (2k)
2	TSATSALASHVILI Luka, Taifu Judo Club (3k)
3	ABDULLAYEV Rza, Olympic Judo Centre (3k)
3	TREMBLAY Tayven, St. Albert Tokai Judo Society (2k)

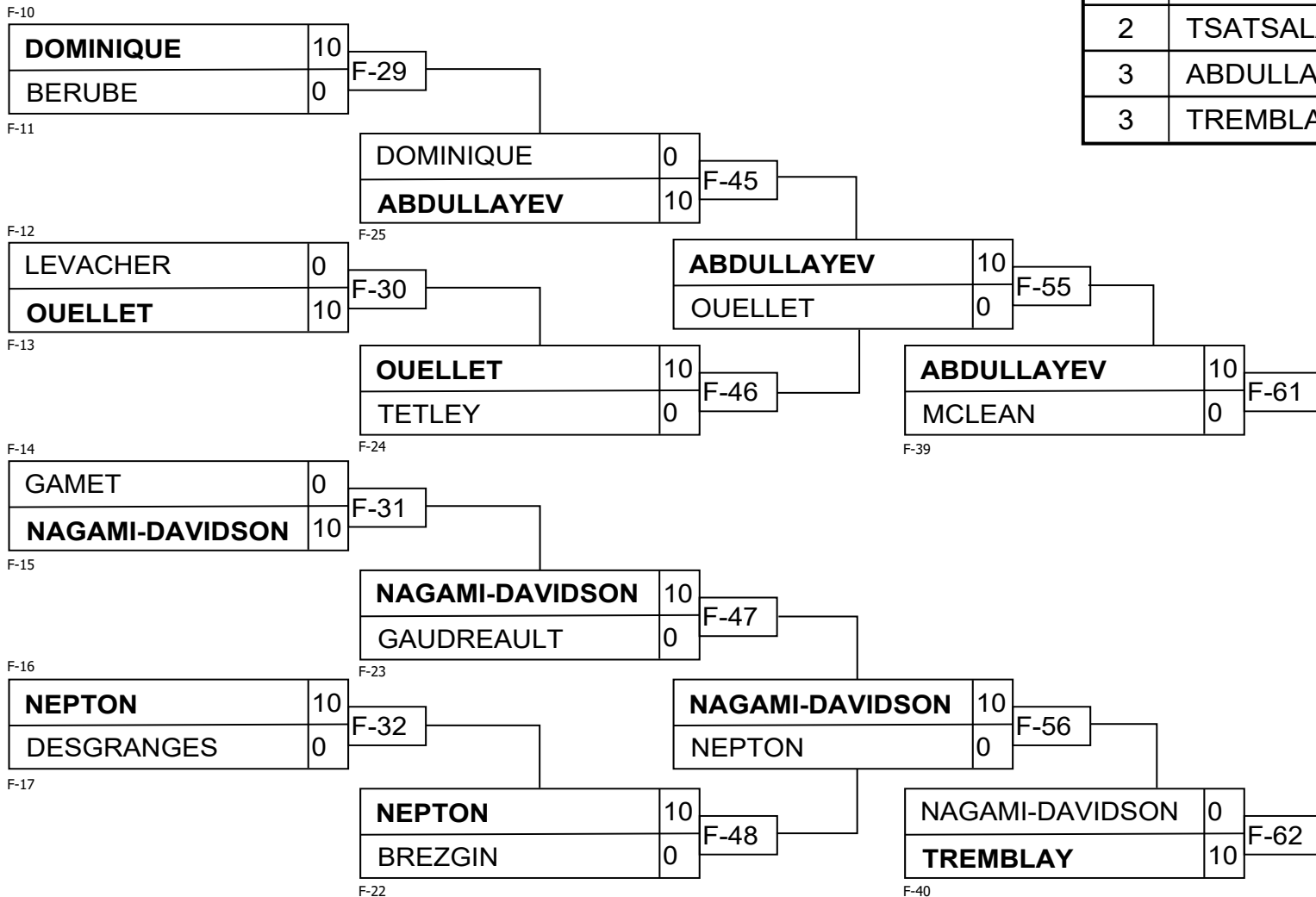

U16M -42

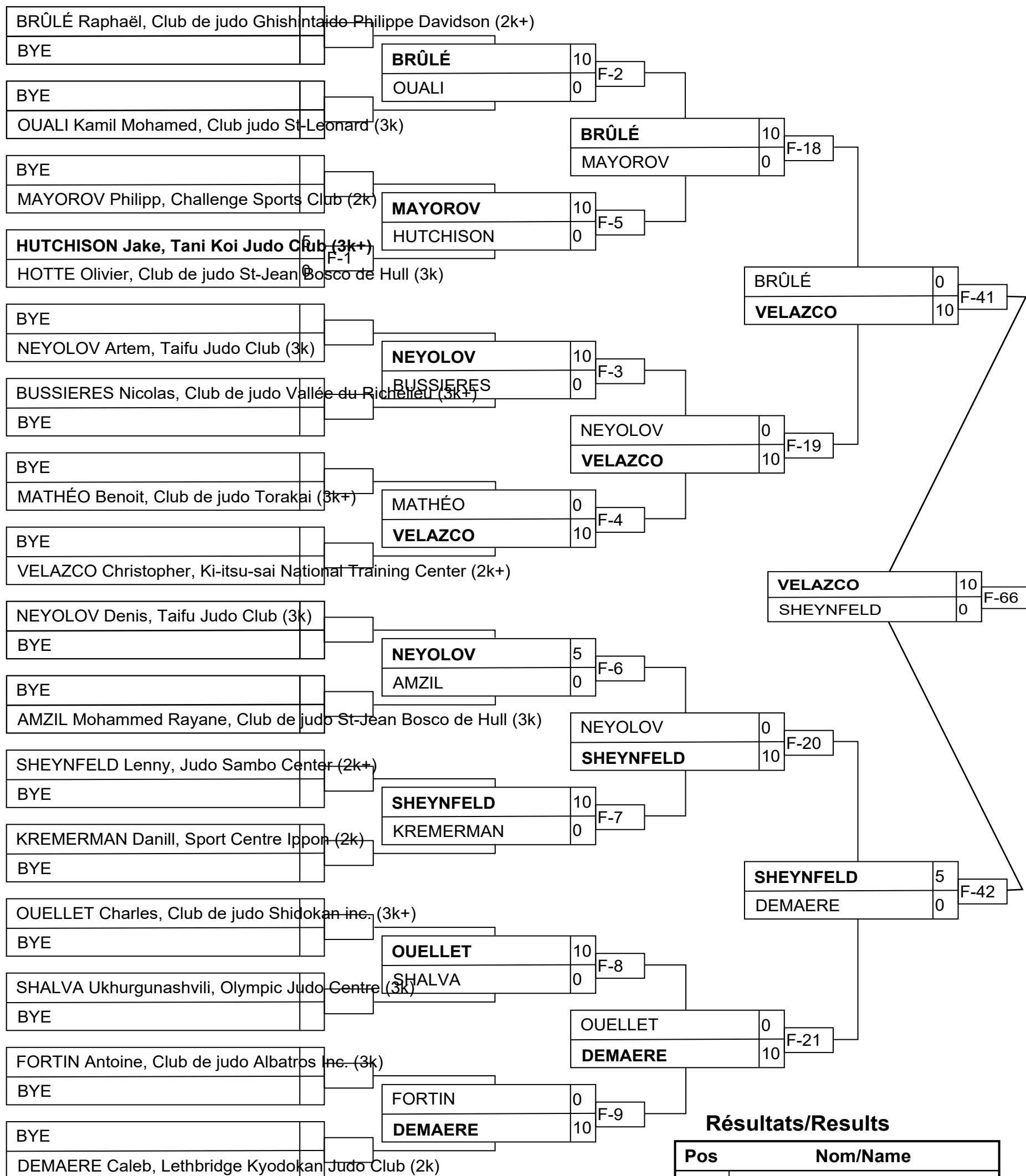

Résultats/Results

Pos	Nom/Name
1	VELAZCO Christopher, Ki-itsu-sai National
2	SHEYNFELD Lenny, Judo Sambo Center
3	OUELLET Charles, Club de judo Shidokan
3	DEMAERE Caleb, Lethbridge Kyodokan JU

U16M -42

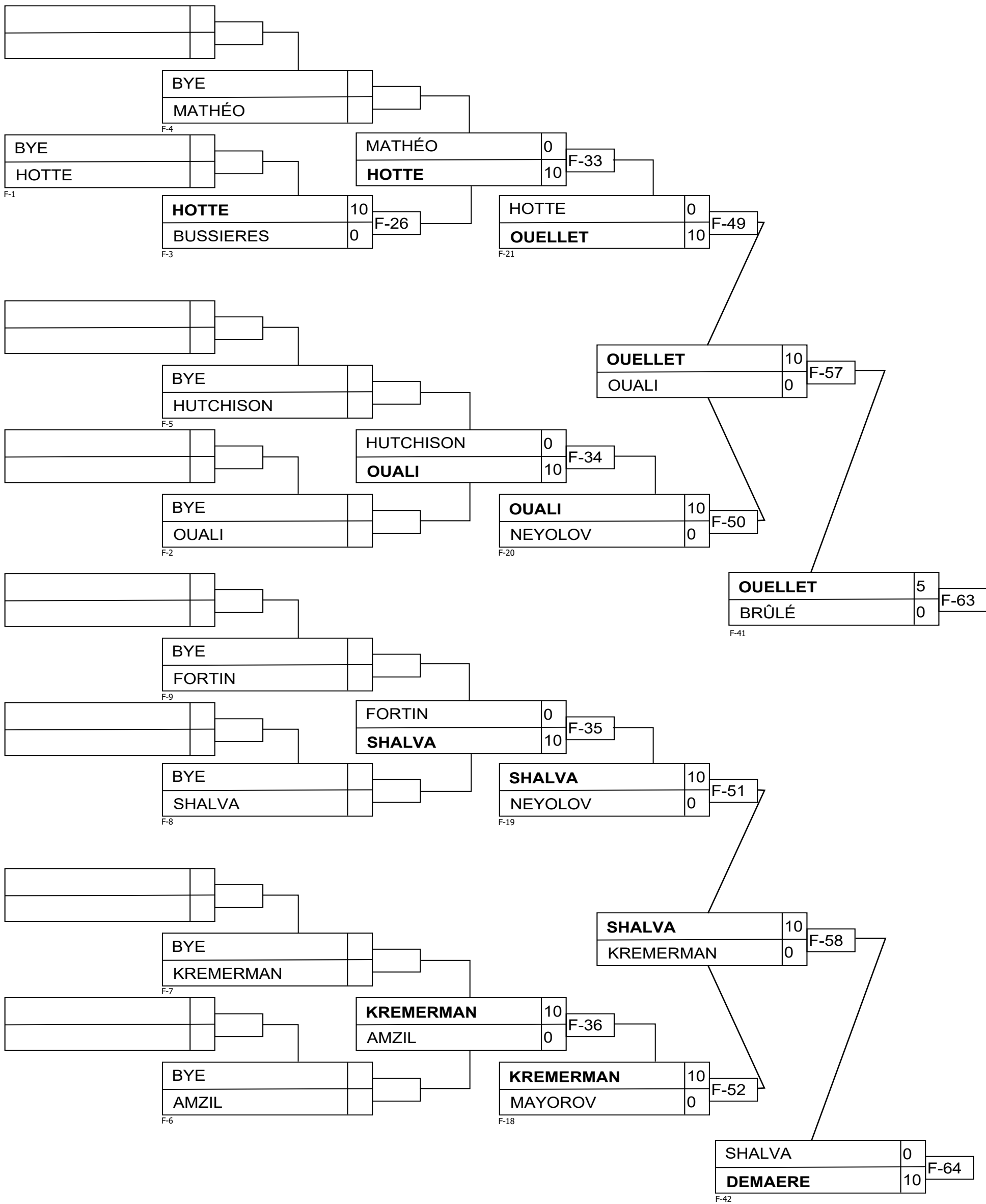

U16M -46

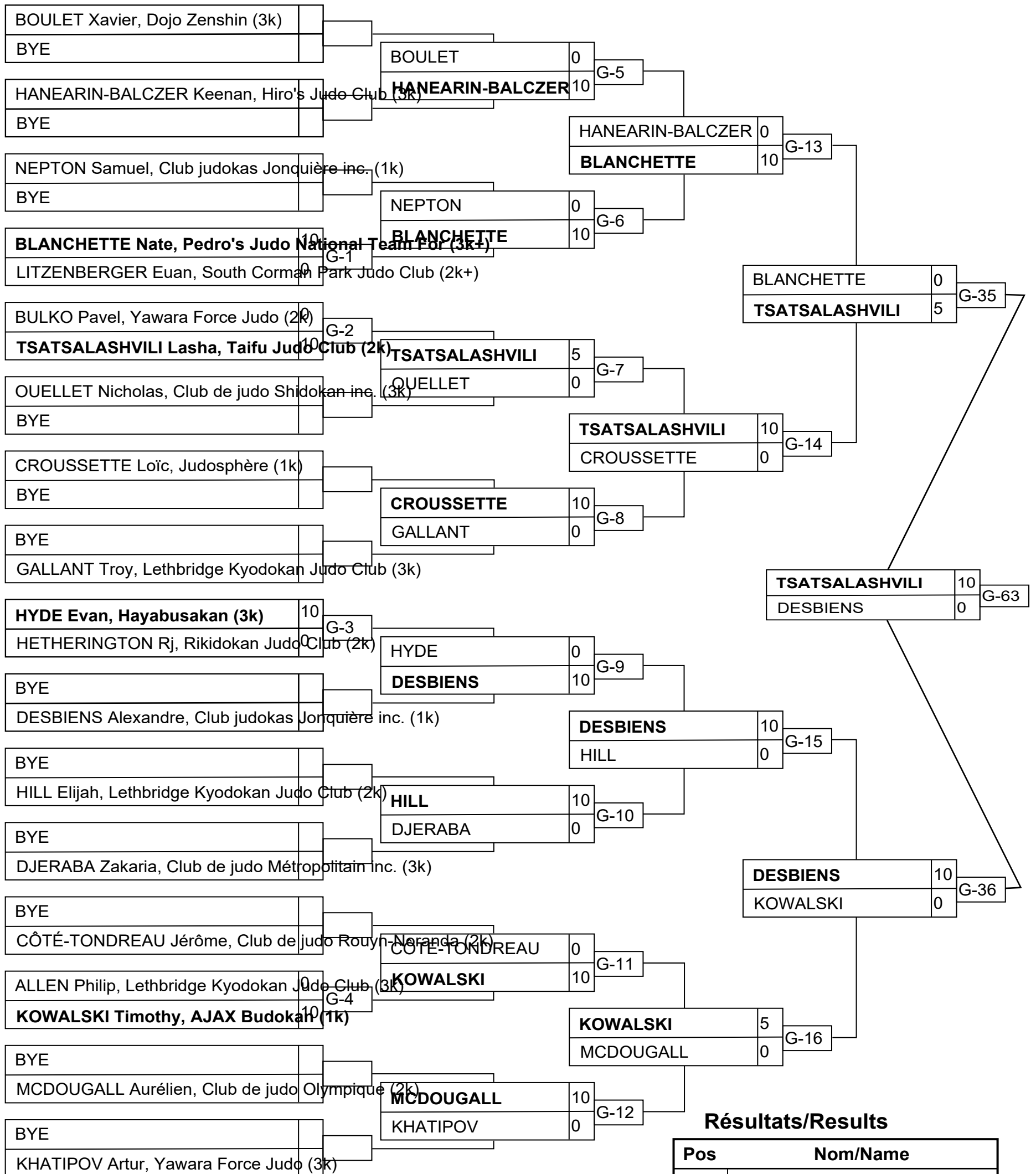

Résultats/Results

Pos	Nom/Name
1	TSATSALASHVILI Lasha, Taifu Judo Club
2	DESBIENS Alexandre, Club judokas Jonquièrre inc.
3	BLANCHETTE Nate, Pedro's Judo National Team For
3	ALLEN Philip, Lethbridge Kyodokan Judo Club

U16M -46

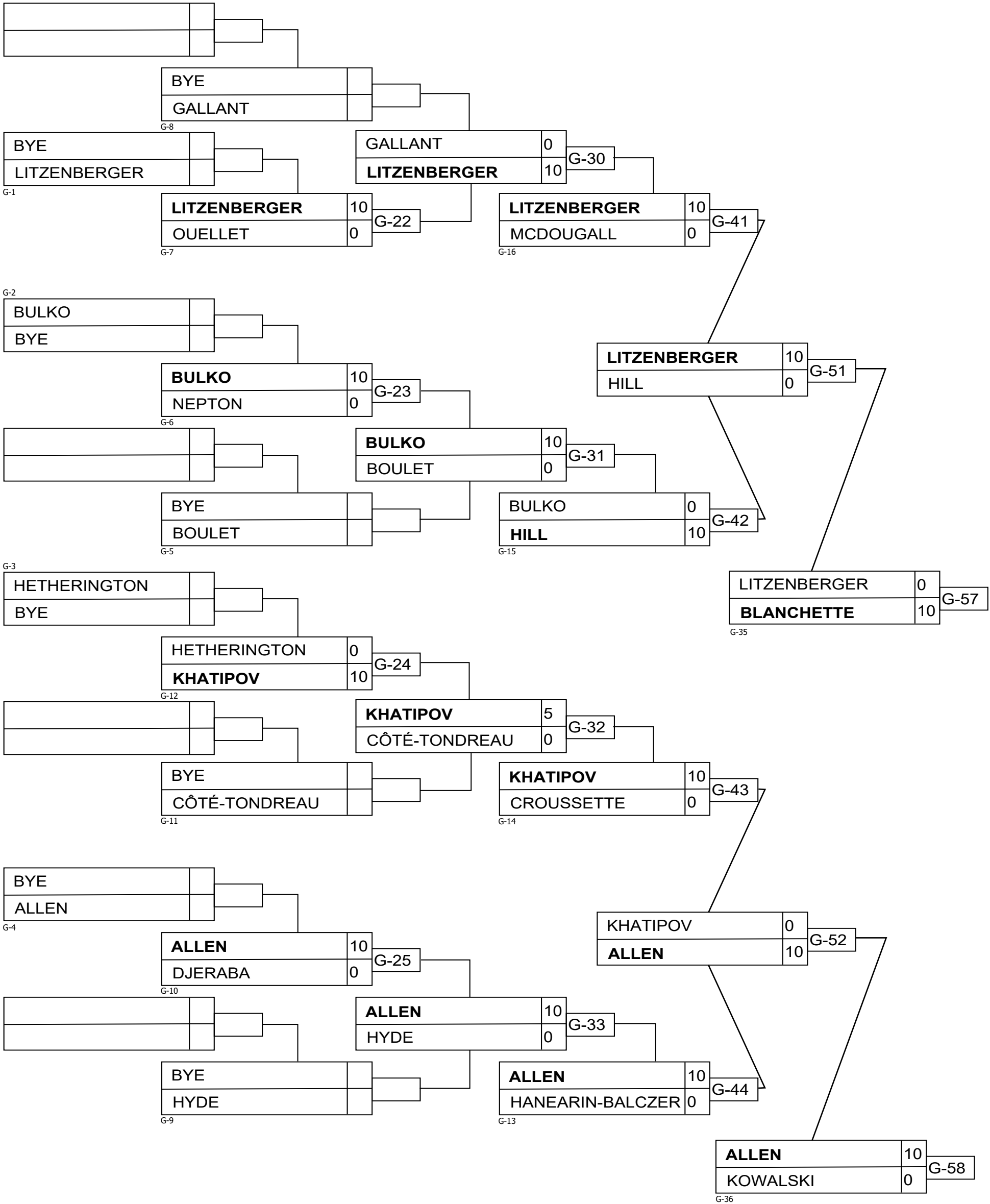

U16M -50

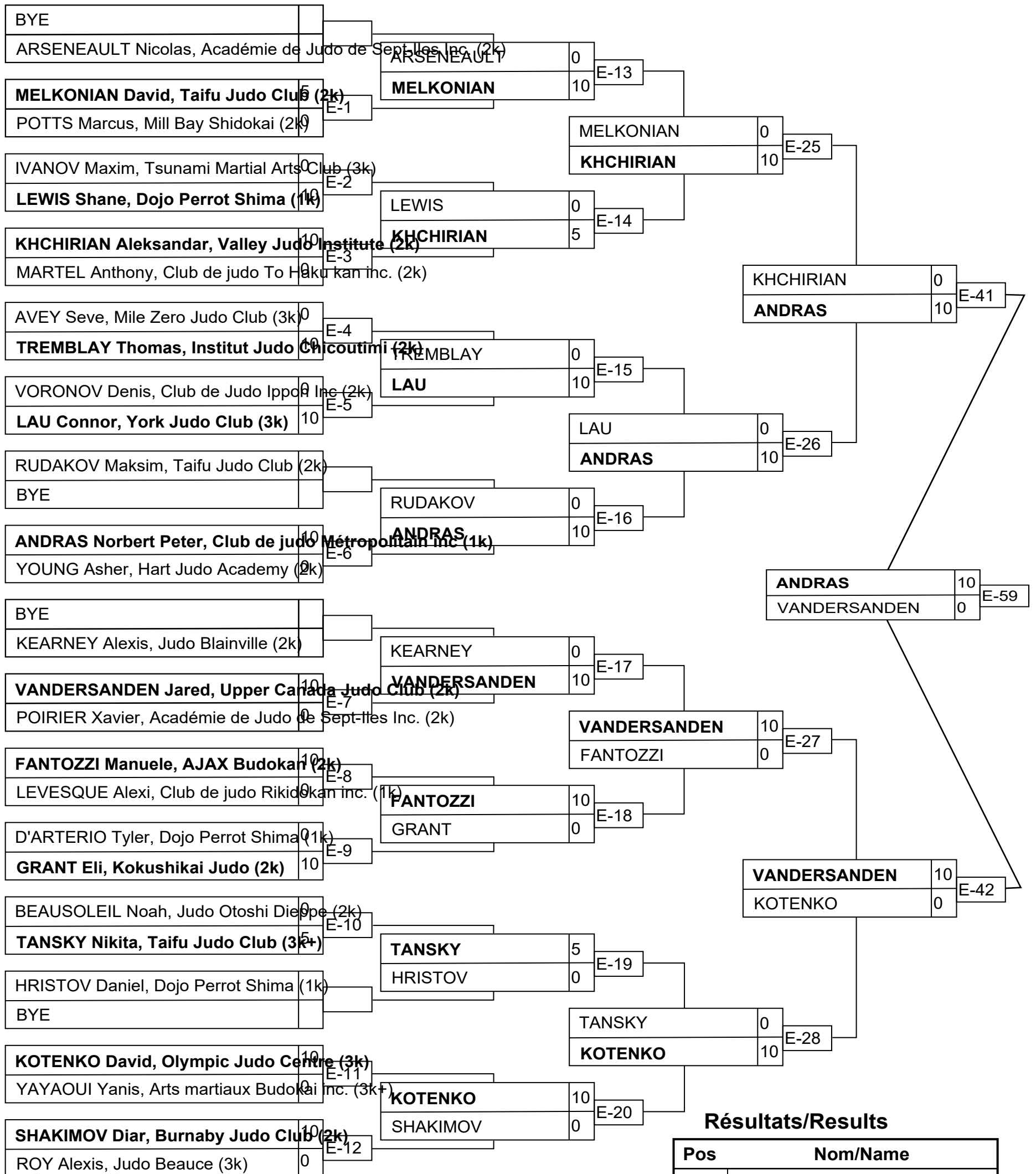

Résultats/Results

Pos	Nom/Name
1	ANDRAS Norbert Peter, Club de judo Métropolitain inc. (1k)
2	VANDERSANDEN Jared, Upper Canada Judo Club (2k)
3	KHCHIRIAN Aleksandar, Valley Judo Institute (2k)
3	LAU Connor, York Judo Club (3k)

U16M -50

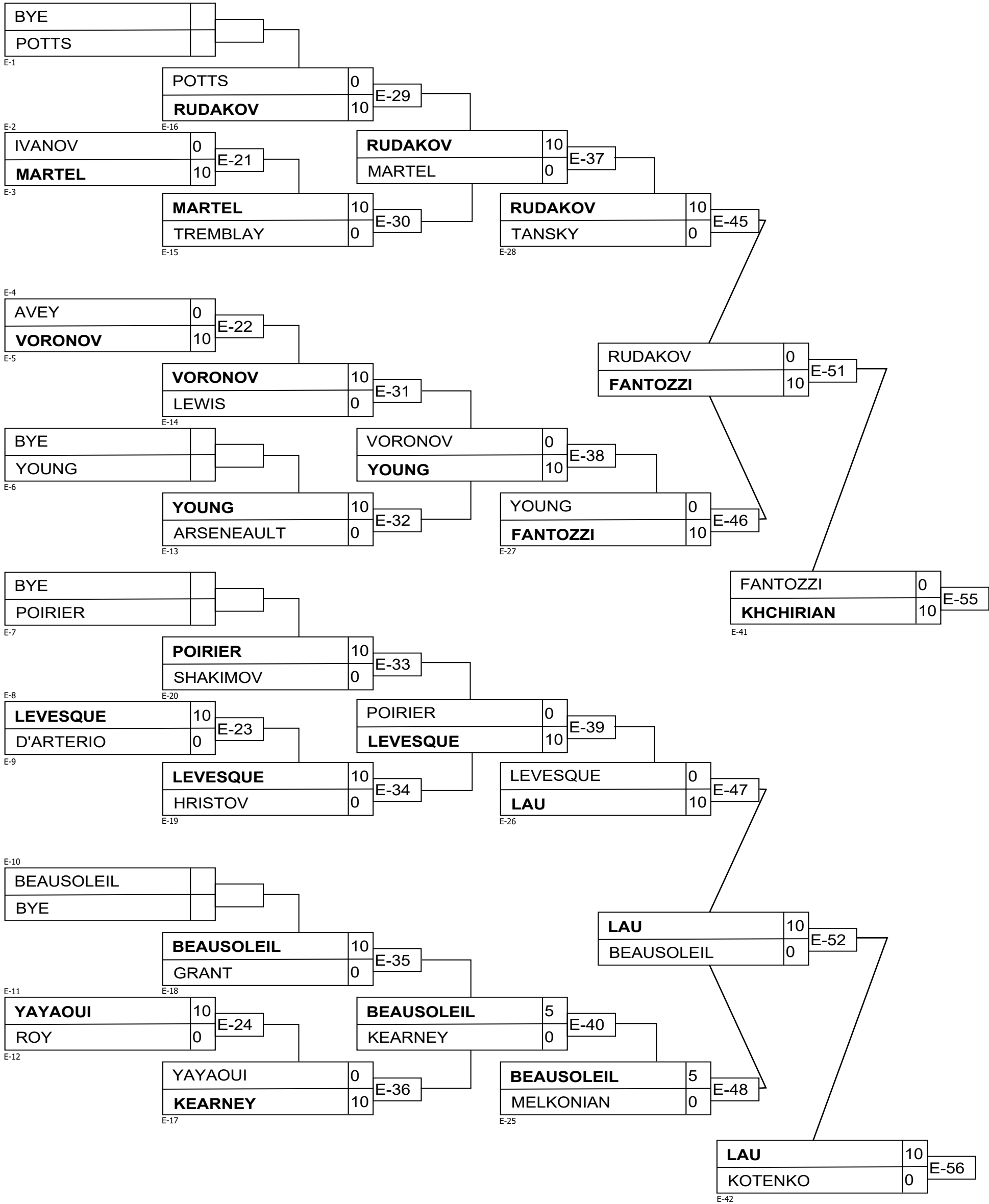

U16M +73

Compétiteurs/Competitors A

#	Nom/Name	Grade	Club	1	2	3	G/W	Pts	Pos
1	KANE Jamal (0,00)	3k	Club de judo Olympique	XX			0	0	3
2	NERON Pascal (0,00)	2k	Club de judo St-Jean Bosco de Hull	10	XX		1	10	2
3	POPOV Joseph (0,00)	2k	Toronto Judo Kai	10	10	XX	2	20	1

Matches/Matches A

Match	Blanc/White			Bleu/Blue	Rés/Res	Tmp/Tim	Code
E-43	KANE Jamal	1	2	NERON Pascal	0 - 10	4:10	GSI
E-49	KANE Jamal	1	3	POPOV Joseph	0 - 10	0:18	WIP
E-53	NERON Pascal	2	3	POPOV Joseph	0 - 10	0:28	IPO

Compétiteurs/Competitors B

#	Nom/Name	Grade	Club	4	5	6	G/W	Pts	Pos
4	MARCOUILLER Jordan (0,00)	3k	Club de Judo Shawinigan	XX			0	0	3
5	BÉLAL Rayan (0,00)	3k+	Club de judo Olympique	10	XX		1	10	2
6	CROOK Shion (0,00)	2k	Hiro's Judo Club	10	10	XX	2	20	1

Matches/Matches B

Match	Blanc/White			Bleu/Blue	Rés/Res	Tmp/Tim	Code
E-44	MARCOUILLER Jordan	4	5	BÉLAL Rayan	0 - 10	1:01	IPO
E-50	MARCOUILLER Jordan	4	6	CROOK Shion	0 - 10	0:13	IPO
E-54	BÉLAL Rayan	5	6	CROOK Shion	0 - 10	0:18	IPO

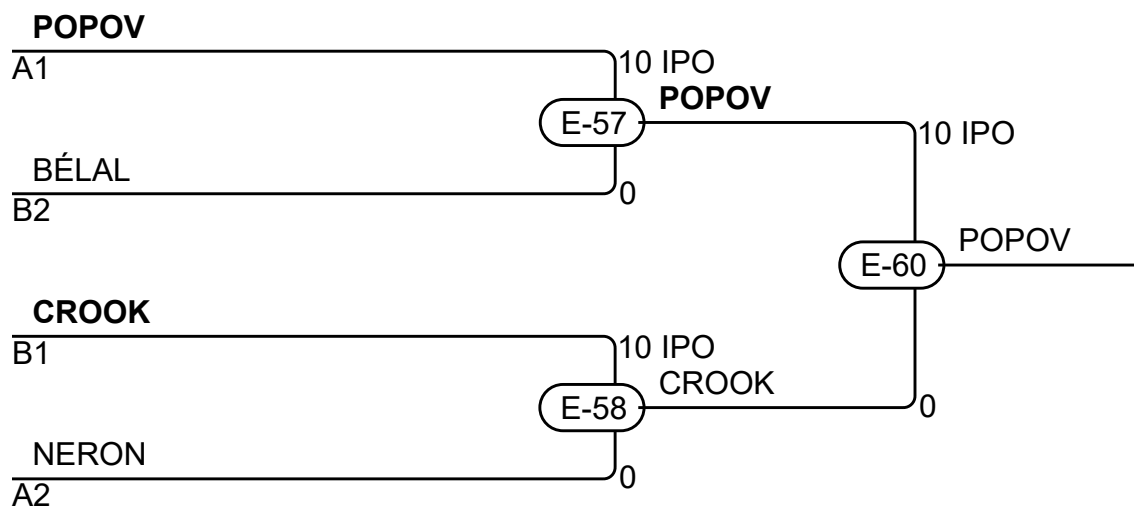

Résultats/Results

Pos	Nom/Name
1	POPOV Joseph, Toronto Judo Kai
2	CROOK Shion, Hiro's Judo Club
3	BÉLAL Rayan, Club de judo Olympique
3	NERON Pascal, Club de judo St-Jean Bosco de Hull