

# TT U16F -48

## Competitors

#	Name	Grade	Club	1	2	3	Wins	Pts	Pos
1	JOBIN Léa	3k	JSK Laterrière	XX	10	10	2	20	1
2	PRUS-CZARNECKA Anna	2k	Judo Alberta		XX	10	1	10	2
3	HAYES Destiny	2k	Bushido			XX	0	0	3

## Matches

Match	White			Blue	Result	Time	Code
C-83A	JOBIN Léa	1	2	PRUS-CZARNECKA Anna	10 - 0	0:42	IPO
C-83B	JOBIN Léa	1	3	HAYES Destiny	10 - 0	1:51	IPO
C-83C	PRUS-CZARNECKA Anna	2	3	HAYES Destiny	10 - 0	1:26	IPO

## Results

Pos	Name
1	JOBIN Léa, JSK Laterrière
2	PRUS-CZARNECKA Anna, Judo Alberta

# U14F -36

## Competitors

#	Name	Grade	Club	1	2	3	4	Wins	Pts	Pos
1	GAGNON Laurence	3k	Club judokas Jonquière	XX	10	10	10	3	30	1
2	GAGNON Naomie	3k	Sept-Iles		XX			0	0	4
3	PERRY Shayna	3k	Team PEI		5	XX	10	2	15	2
4	ROBINSON Shanie	3k	Club de judo Otoshi		10		XX	1	10	3

## Matches

Match	White			Blue	Result	Time	Code
A-11	<b>GAGNON Laurence</b>	1	2	GAGNON Naomie	10 - 0	0:34	IPO
A-12	<b>PERRY Shayna</b>	3	4	ROBINSON Shanie	10 - 0	0:53	IPO
A-17	<b>GAGNON Laurence</b>	1	3	PERRY Shayna	10 - 0	1:48	IPO
A-18	GAGNON Naomie	2	4	<b>ROBINSON Shanie</b>	0 - 10	2:17	HAN
A-25	<b>GAGNON Laurence</b>	1	4	ROBINSON Shanie	10 - 0	1:20	IPO
A-26	GAGNON Naomie	2	3	<b>PERRY Shayna</b>	0 - 5	3:00	WAZ

## Results

Pos	Name
1	GAGNON Laurence, Club judokas Jonquière
2	PERRY Shayna, Team PEI
3	ROBINSON Shanie, Club de judo Otoshi

# U14F -48

## Competitors

#	Name	Grade	Club	1	2	1	2	1	2	Wins	Pts	Pos
1	CHEVALIER MARGOT	3k	Hayabusakan	XX		XX		XX		0	0	2
2	MARTINEAU Marjorie	3k	Institut judo Chicoutimi	10	XX	10	XX		XX	2	20	1

## Matches

Match	White			Blue	Result	Time	Code
A-10	CHEVALIER MARGOT	1	2	MARTINEAU Marjorie	0 - 10	1:25	IPO
A-16	MARTINEAU Marjorie	2	1	CHEVALIER MARGOT	10 - 0	0:26	IPO
A-24	CHEVALIER MARGOT	1	2	MARTINEAU Marjorie			

## Results

Pos	Name
1	MARTINEAU Marjorie, Institut judo Chicoutimi

# U14F -57

## Competitors

#	Name	Grade	Club	1	2	1	2	1	2	Wins	Pts	Pos
1	CHARNEAU Adèle	3k	St-Paul l'Ermite	XX	10	XX	10	XX		2	20	1
2	ST-ONGE Mélodie	3k	Club de Judo d'Asbestos		XX		XX		XX	0	0	2

## Matches

Match	White			Blue	Result	Time	Code
D-25	CHARNEAU Adèle	1	2	ST-ONGE Mélodie	10 - 0	1:37	IPO
D-30	ST-ONGE Mélodie	2	1	CHARNEAU Adèle	0 - 10	0:01	FUS
D-33	CHARNEAU Adèle	1	2	ST-ONGE Mélodie			

## Results

Pos	Name
1	CHARNEAU Adèle, St-Paul l'Ermite

# U14M -55

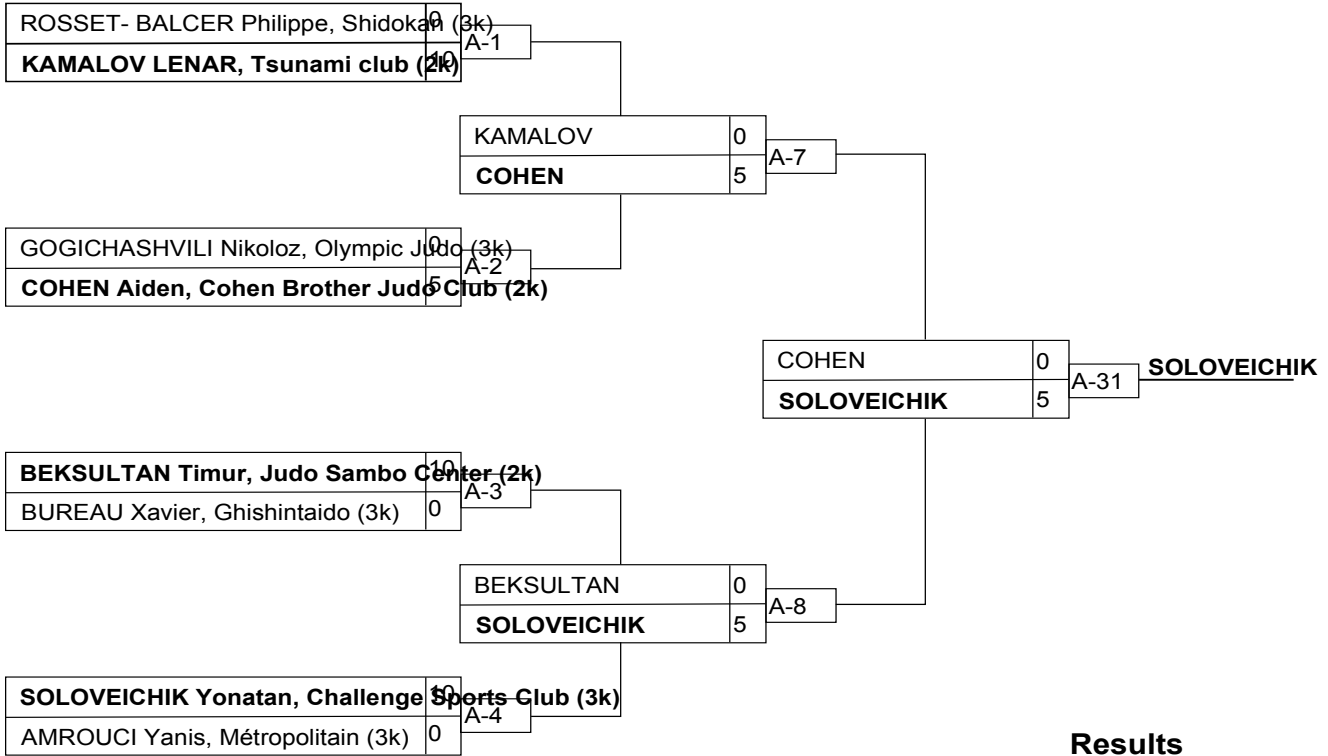

## Results

Pos	Name
1	SOLOVEICHIK Yonatan, Challenge Sports Club (3k)
2	COHEN Aiden, Cohen Brother Judo Club (2k)
3	AMROUCI Yanis, Métropolitain (3k)
3	BEKSULTAN Timur, Judo Sambo Center (2k)

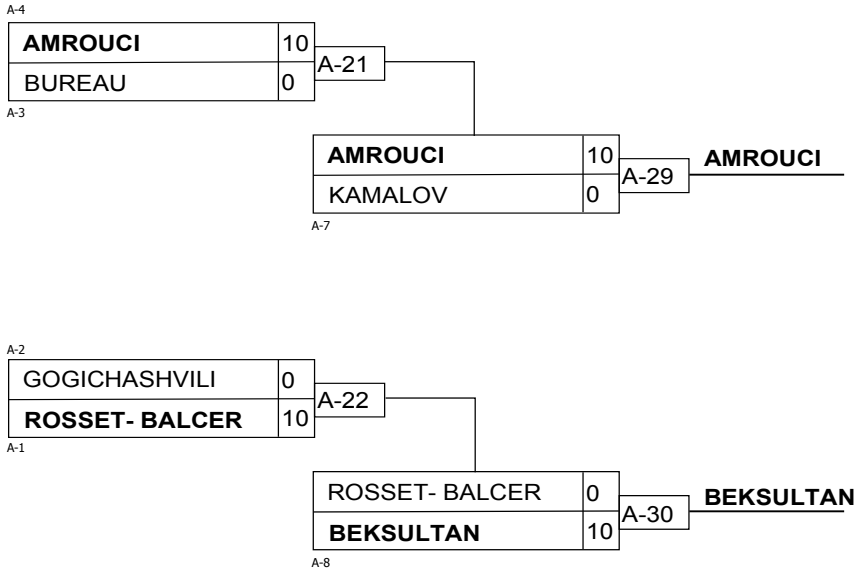

# U14M -60

## Competitors A

#	Name	Grade	Club	1	2	3	Wins	Pts	Pos
1	DURAND Vincent	3k	CJVR	XX	10	5	2	15	1
2	SERRANO Matthew	3k	Ajax Budokan		XX		0	0	3
3	VILLENEUVE Francis	3k	Sept-Iles		10	XX	1	10	2

## Matches A

Match	White	Blue	Result	Time	Code
A-5	DURAND Vincent	1 2 SERRANO Matthew	10 - 0	0:01	FUS
A-13	DURAND Vincent	1 3 VILLENEUVE Francis	5 - 0	3:00	WAZ
A-19	SERRANO Matthew	2 3 VILLENEUVE Francis	0 - 10	0:01	FUS

## Competitors B

#	Name	Grade	Club	4	5	6	Wins	Pts	Pos
4	DUHAMEL Loïc-Olivier	3k	CJVR	XX			0	0	3
5	SAUMURE Henri	3k	Boucherville	10	XX		1	10	2
6	KARPUKOV Arthur	3k	Shidokan	10	10	XX	2	20	1

## Matches B

Match	White	Blue	Result	Time	Code
A-6	DUHAMEL Loïc-Olivier	4 5 SAUMURE Henri	0 - 10	1:24	IPO
A-14	DUHAMEL Loïc-Olivier	4 6 KARPUKOV Arthur	0 - 10	0:07	IPO
A-20	SAUMURE Henri	5 6 KARPUKOV Arthur	0 - 10	0:08	IPO

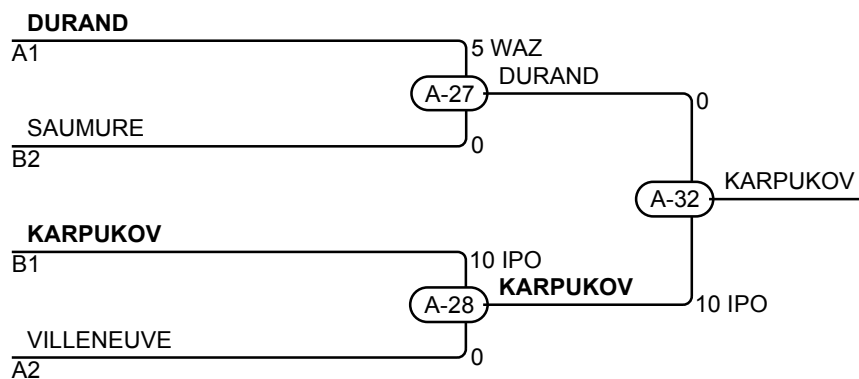

## Results

Pos	Name
1	KARPUKOV Arthur, Shidokan
2	DURAND Vincent, CJVR
3	SAUMURE Henri, Boucherville
3	VILLENEUVE Francis, Sept-Iles

# U14M +66

## Competitors

#	Name	Grade	Club	1	2	3	Wins	Pts	Pos
1	BELAL RAYAN	3k	Club de judo Olympique	XX	10	10	2	20	1
2	MARCOUILLER Jordan	3k	Ghishintaido		XX		0	0	3
3	PAKU Elom	3k	Dojo Perrot Shima		10	XX	1	10	2

## Matches

Match	White			Blue	Result	Time	Code
A-9	<b>BELAL RAYAN</b>	1	2	MARCOUILLER Jordan	10 - 0	0:38	IPO
A-15	<b>BELAL RAYAN</b>	1	3	PAKU Elom	10 - 0	1:32	IPO
A-23	MARCOUILLER Jordan	2	3	<b>PAKU Elom</b>	0 - 10	1:34	IPO

## Results

Pos	Name
1	BELAL RAYAN, Club de judo Olympique
2	PAKU Elom, Dojo Perrot Shima

# U16F -36

## Competitors

#	Name	Grade	Club	1	2	1	2	1	2	Wins	Pts	Pos
1	CALTAGIRONE Alissa	2k+	MAYO QUANCHI	XX		XX		XX		0	0	2
2	BEATON Evelyn	3k	Judo Alberta	10	XX	5	XX		XX	2	15	1

## Matches

Match	White			Blue	Result	Time	Code
D-54	CALTAGIRONE Alissa	1	2	BEATON Evelyn	0 - 10	2:02	IPO
D-62	BEATON Evelyn	2	1	CALTAGIRONE Alissa	5 - 0	3:00	WAZ
D-68	CALTAGIRONE Alissa	1	2	BEATON Evelyn			

## Results

Pos	Name
1	BEATON Evelyn, Judo Alberta



# U16F -48

## Competitors A

#	Name	Grade	Club	1	2	3	4	Wins	Pts	Pos
1	SIMARD-LEJEUNE Mathilde	3k	Seiko	XX	10	5	10	3	25	1
2	JOBIN Léa	3k	JSK Laterrière		XX	10	10	2	20	2
3	PRUS-CZARNECKA Anna	2k	Judo Alberta			XX	10	1	10	3
4	HAYES Destiny	2k	Bushido				XX	0	0	4

## Matches A

Match	White	Blue	Result	Time	Code
C-67	SIMARD-LEJEUNE Mathilde 1 2	JOBIN Léa	10 - 0	2:00	IPO
C-68	PRUS-CZARNECKA Anna 3 4	HAYES Destiny	10 - 0	0:45	IPO
C-72	SIMARD-LEJEUNE Mathilde 1 3	PRUS-CZARNECKA Anna	5 - 0	3:00	WAZ
C-73	JOBIN Léa 2 4	HAYES Destiny	10 - 0	0:29	IPO
C-77	SIMARD-LEJEUNE Mathilde 1 4	HAYES Destiny	10 - 0	1:08	IPO
C-78	JOBIN Léa 2 3	PRUS-CZARNECKA Anna	10 - 0	2:52	IPO

## Competitors B

#	Name	Grade	Club	5	6	7	Wins	Pts	Pos
5	GAULIN Katherine	3k	Juvaldo	XX			0	0	3
6	TURCOTTE Béatrice	2k	Varenes	10	XX		1	10	2
7	ZHITAREVA Anna	1k	JCCC	10	10	XX	2	20	1

## Matches B

Match	White	Blue	Result	Time	Code
C-69	GAULIN Katherine 5 6	TURCOTTE Béatrice	0 - 10	1:03	IPO
C-74	GAULIN Katherine 5 7	ZHITAREVA Anna	0 - 10	0:09	IPO
C-79	TURCOTTE Béatrice 6 7	ZHITAREVA Anna	0 - 10	0:52	IPO

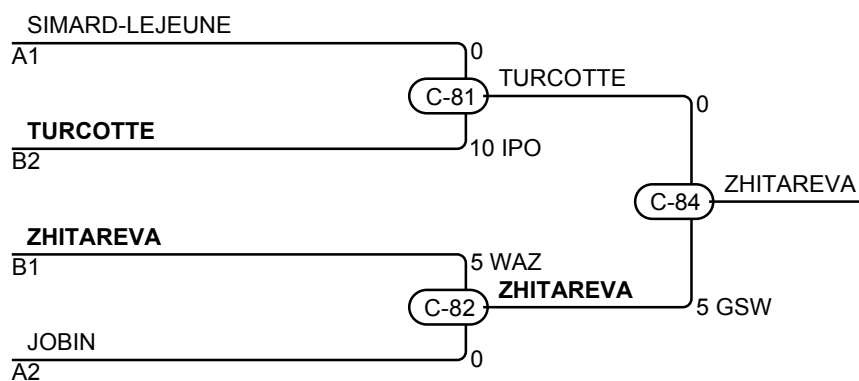

## Results

Pos	Name
1	ZHITAREVA Anna, JCCC
2	TURCOTTE Béatrice, Varenes
3	SIMARD-LEJEUNE Mathilde, Seiko
3	JOBIN Léa, JSK Laterrière

# U16F -63

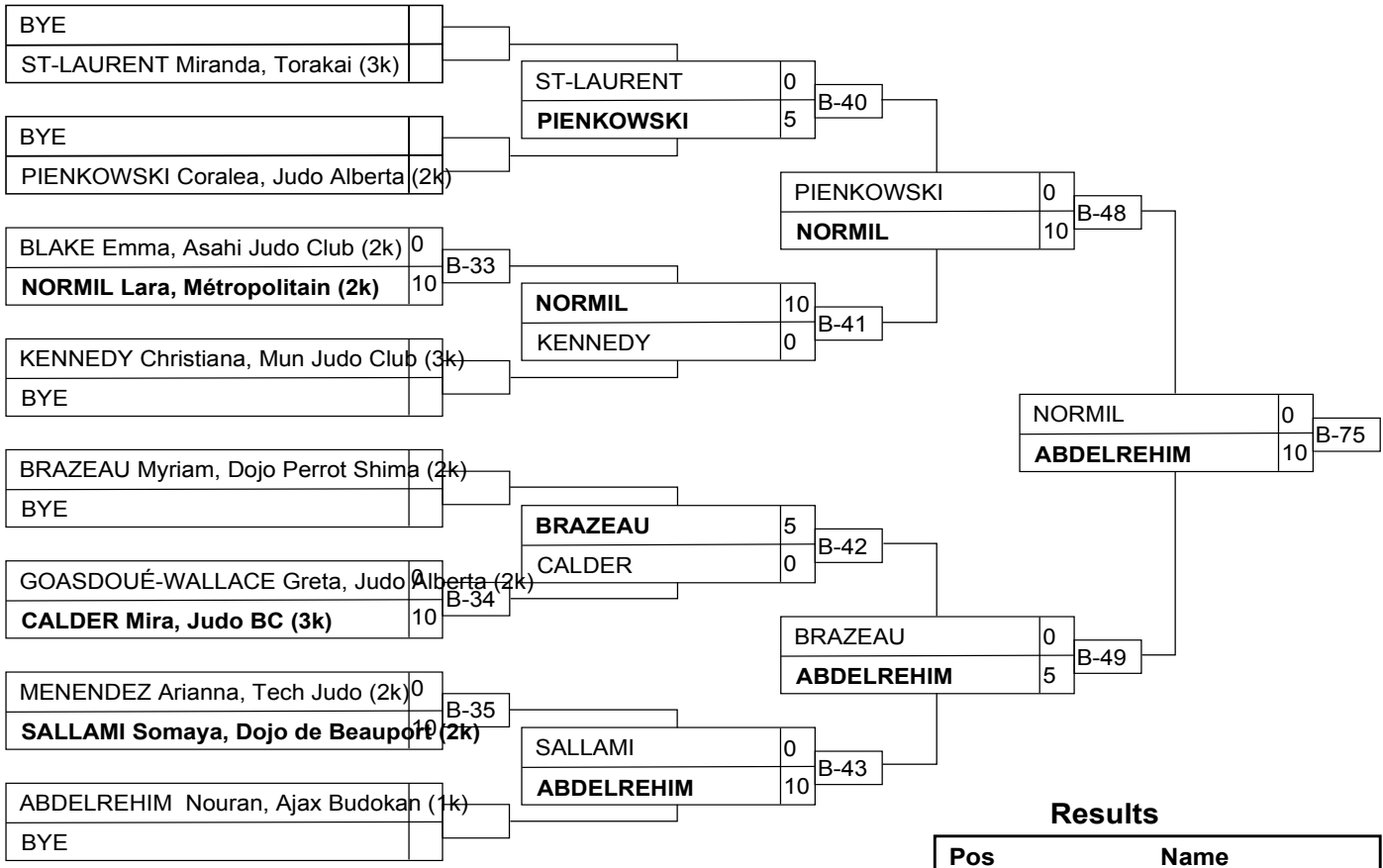

## Results

Pos	Name
1	ABDELREHIM Nouran, Ajax Budokan (1k)
2	NORMIL Lara, Métropolitain (2k)
3	BLAKE Emma, Asahi Judo Club (2k)
3	BRAZEAU Myriam, Dojo Perrot Shima (2k)

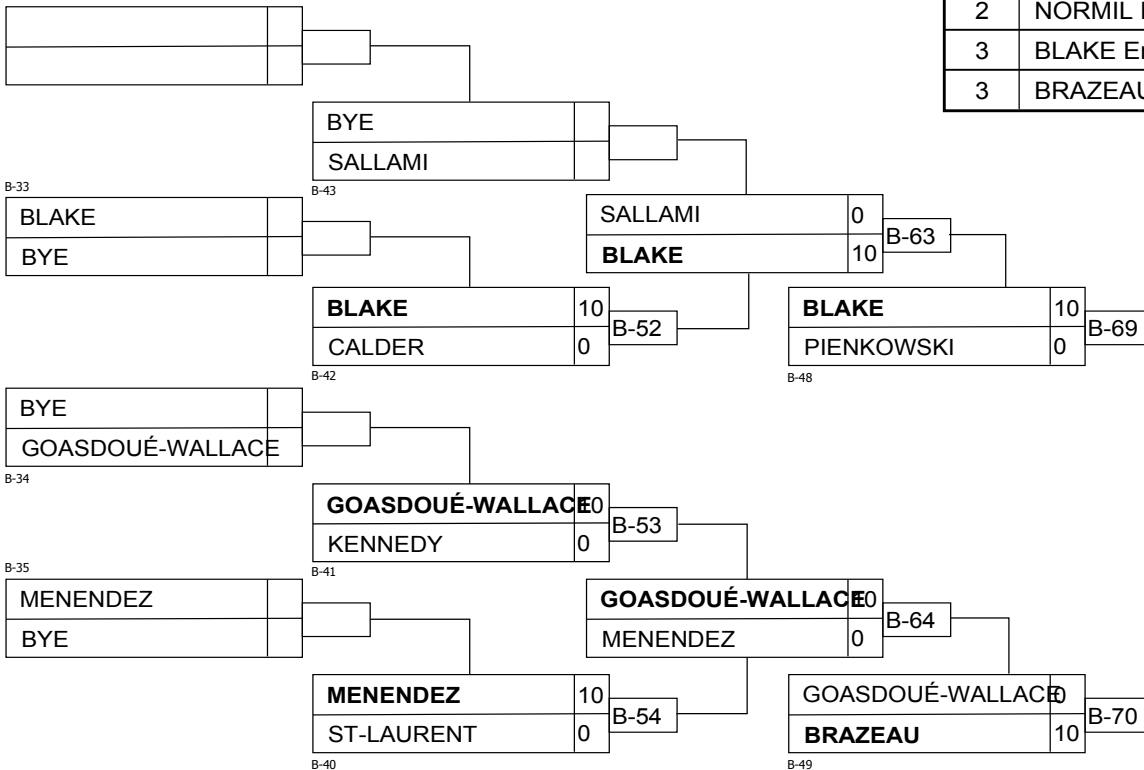

# U16M -34

## Competitors

#	Name	Grade	Club	1	2	3	Wins	Pts	Pos
1	GAUDREAU Thomas-Louis	3k	Seiko	XX	10		1	10	2
2	PASSELANE Jérôme	3k	Varenes		XX		0	0	3
3	OUELLET William	3k	Shidokan	5	10	XX	2	15	1

## Matches

Match	White			Blue	Result	Time	Code
A-63	<b>GAUDREAU Thomas-Louis</b>	1	2	PASSELANE Jérôme	10 - 0	1:14	IPO
A-68	GAUDREAU Thomas-Louis	1	3	<b>OUELLET William</b>	0 - 5	3:00	WAZ
A-73	PASSELANE Jérôme	2	3	<b>OUELLET William</b>	0 - 10	1:17	IPO

## Results

Pos	Name
1	OUELLET William, Shidokan
2	GAUDREAU Thomas-Louis, Seiko

# U16M -38

## Competitors A

#	Name	Grade	Club	1	2	3	4	Wins	Pts	Pos
1	BRÛLÉ Raphael	3k	Ghishintaido	XX		5		1	5	4
2	OUELLET Charles	3k	Shidokan	10	XX			1	10	3
3	HILL Elijah	3k	Judo Alberta		10	XX		1	10	2
4	LITZENBERGER Euan	2k	Judo Saskatchewan	10	10	10	XX	3	30	1

## Matches A

Match	White	Blue	Result	Time	Code
D-51	BRÛLÉ Raphael 1 2	OUELLET Charles	0 - 10	0:11	IPO
D-52	HILL Elijah 3 4	LITZENBERGER Euan	0 - 10	1:47	IPO
D-59	<b>BRÛLÉ Raphael</b> 1 3	HILL Elijah	5 - 0	3:00	WAZ
D-60	OUELLET Charles 2 4	LITZENBERGER Euan	0 - 10	1:03	IPO
D-65	BRÛLÉ Raphael 1 4	LITZENBERGER Euan	0 - 10	0:52	IPO
D-66	OUELLET Charles 2 3	HILL Elijah	0 - 10	4:40	GSI

## Competitors B

#	Name	Grade	Club	5	6	7	Wins	Pts	Pos
5	MAYOROV Philipp	3k	Challenge Sports Club	XX	10		1	10	2
6	ROY Victor	2k	Club de Judo d'Asbestos		XX		0	0	3
7	DEMAERE Caleb	3k	Judo Alberta	5	10	XX	2	15	1

## Matches B

Match	White	Blue	Result	Time	Code
D-53	<b>MAYOROV Philipp</b> 5 6	ROY Victor	10 - 0	0:13	IPO
D-61	MAYOROV Philipp 5 7	<b>DEMAERE Caleb</b>	0 - 5	3:00	WAZ
D-67	ROY Victor 6 7	<b>DEMAERE Caleb</b>	0 - 10	3:00	IPO

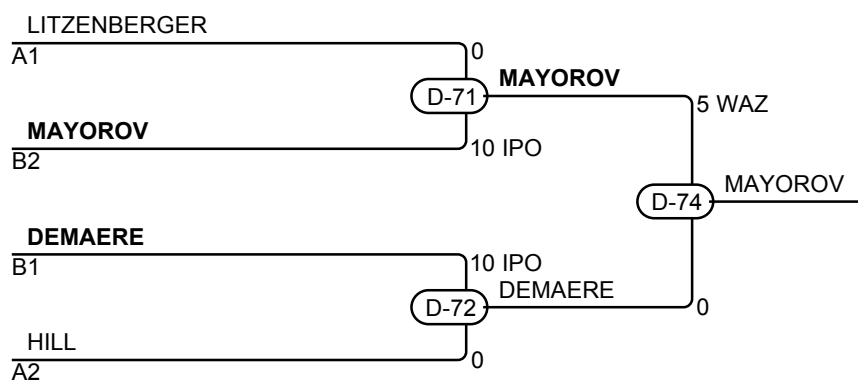

## Results

Pos	Name
1	MAYOROV Philipp, Challenge Sports Club
2	DEMAERE Caleb, Judo Alberta
3	LITZENBERGER Euan, Judo Saskatchewan
3	HILL Elijah, Judo Alberta

# U16M -46

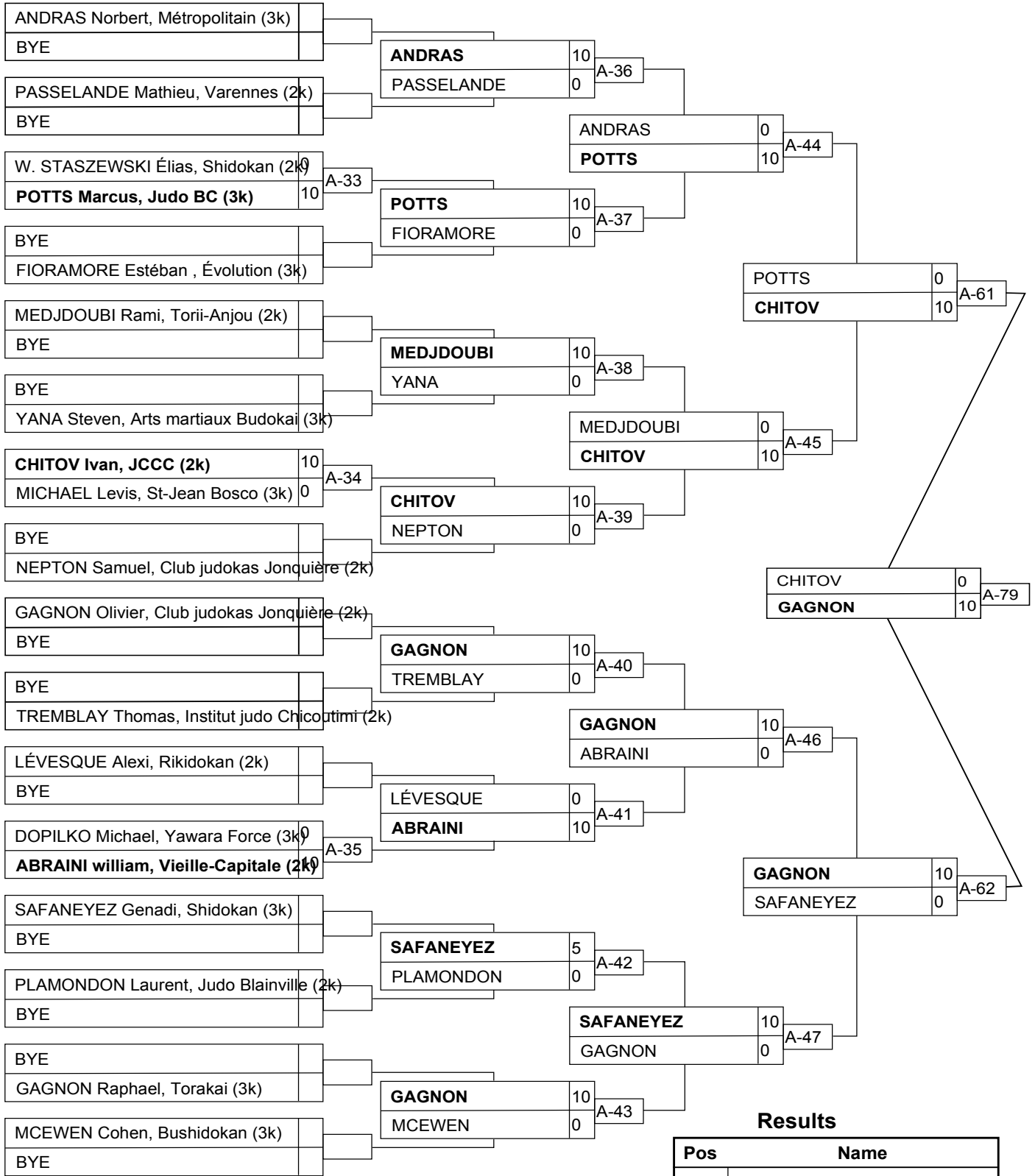

## Results

Pos	Name
1	GAGNON Olivier, Club judokas Jonquière (2k)
2	CHITOV Ivan, JCCC (2k)
3	ABRAINI william, Vieille-Capitale (2k)
3	ANDRAS Norbert, Métropolitain (3k)

# U16M -46

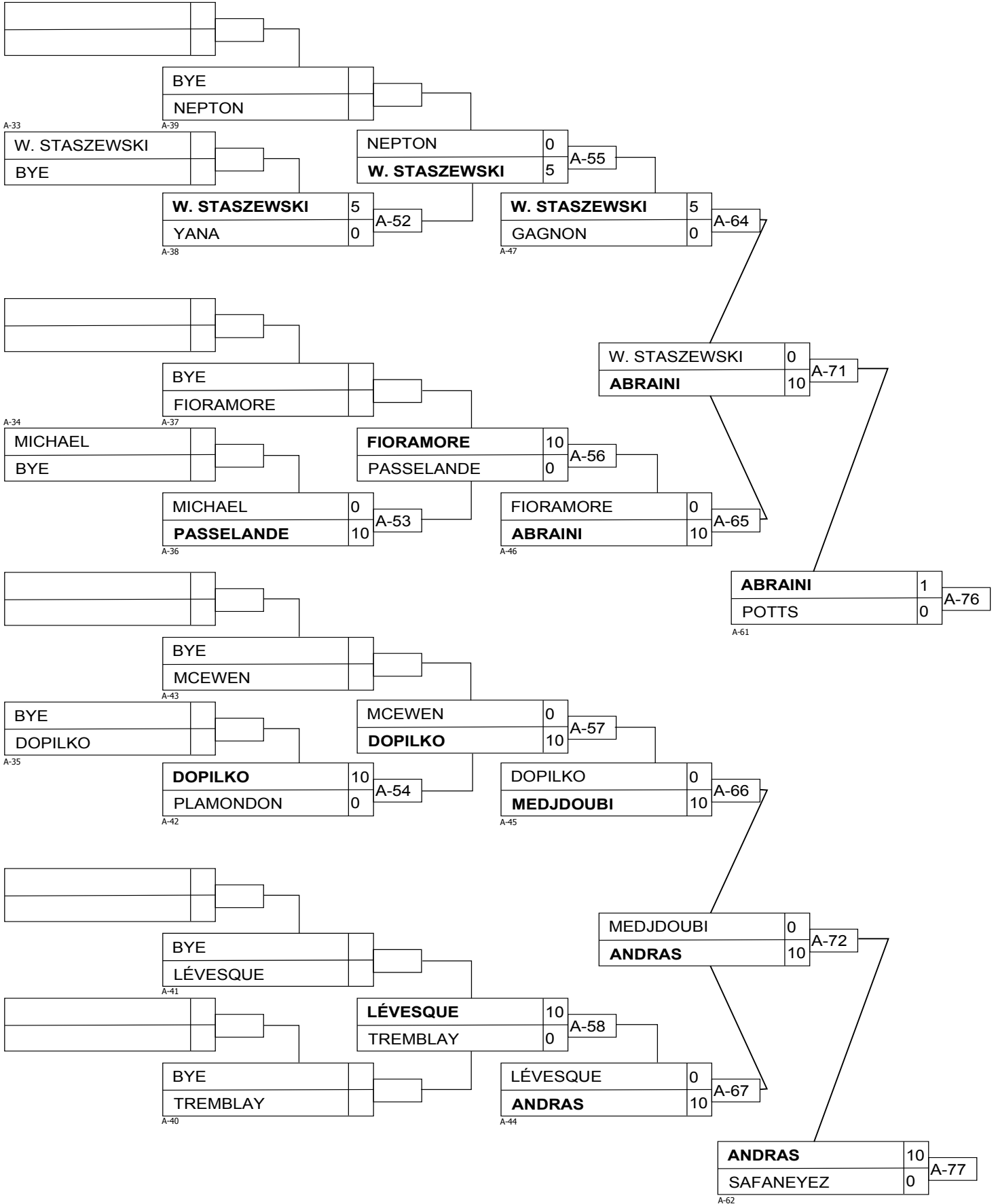



# U16M -55

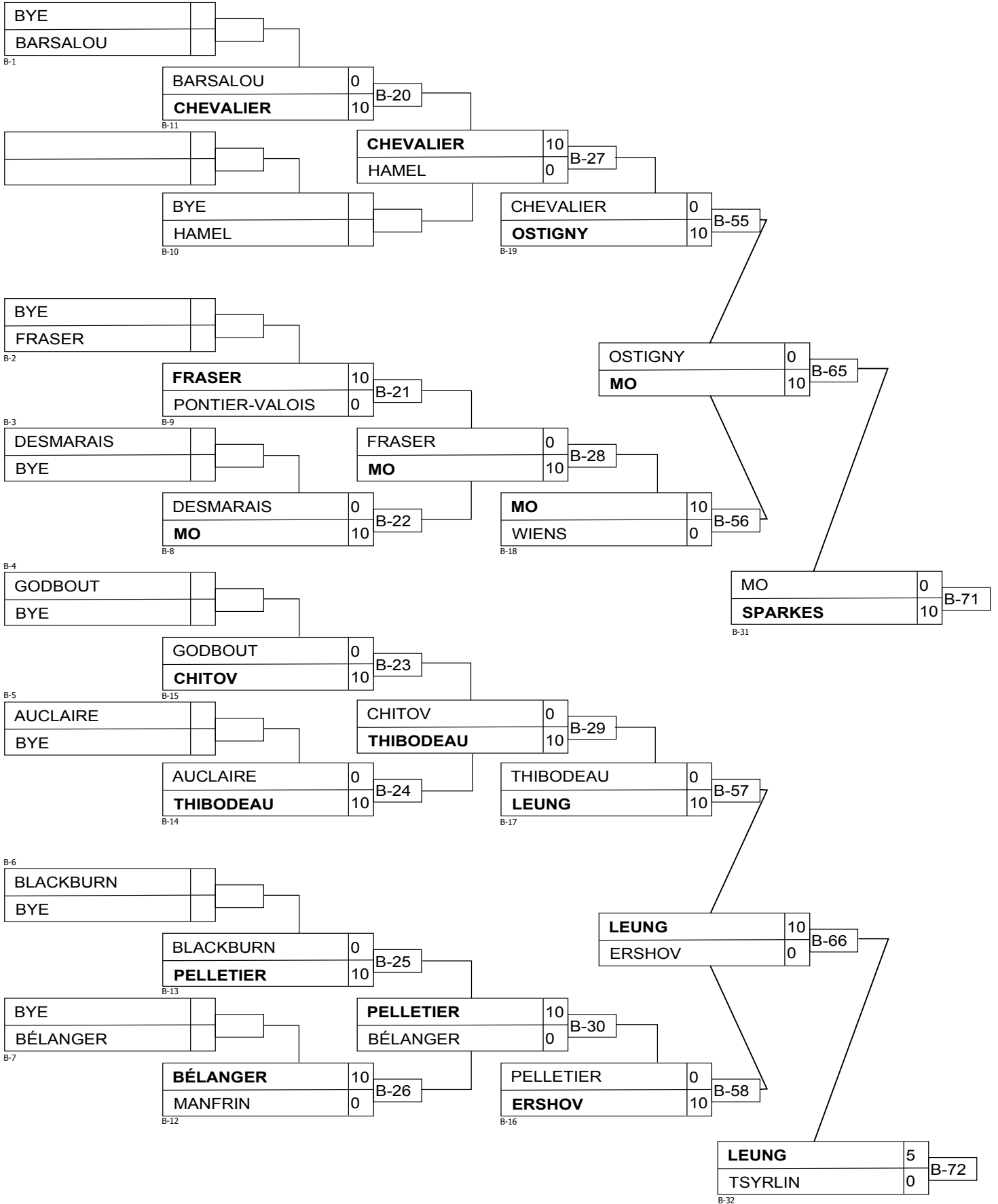



# U16M -60

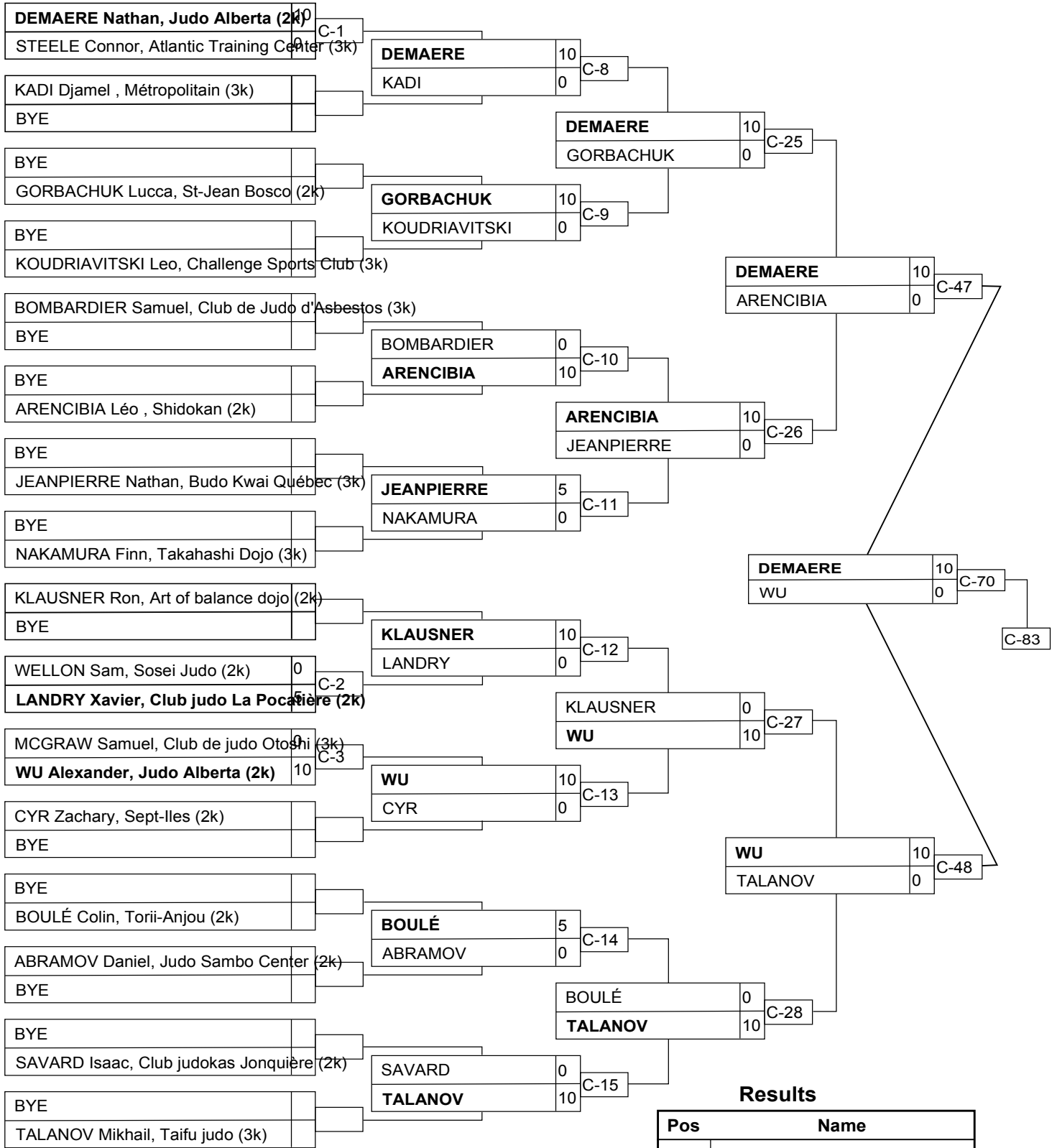

Pos	Name
1	YONEZUKA Jack, Cranford Judo Karate Centre
2	DEMAERE Nathan, Judo Alberta (2k)
3	COULOMBE Jean-Pascal, Sept-Iles (3k)
3	SCHENK Emil, Judo BC (1k)

# U16M -60

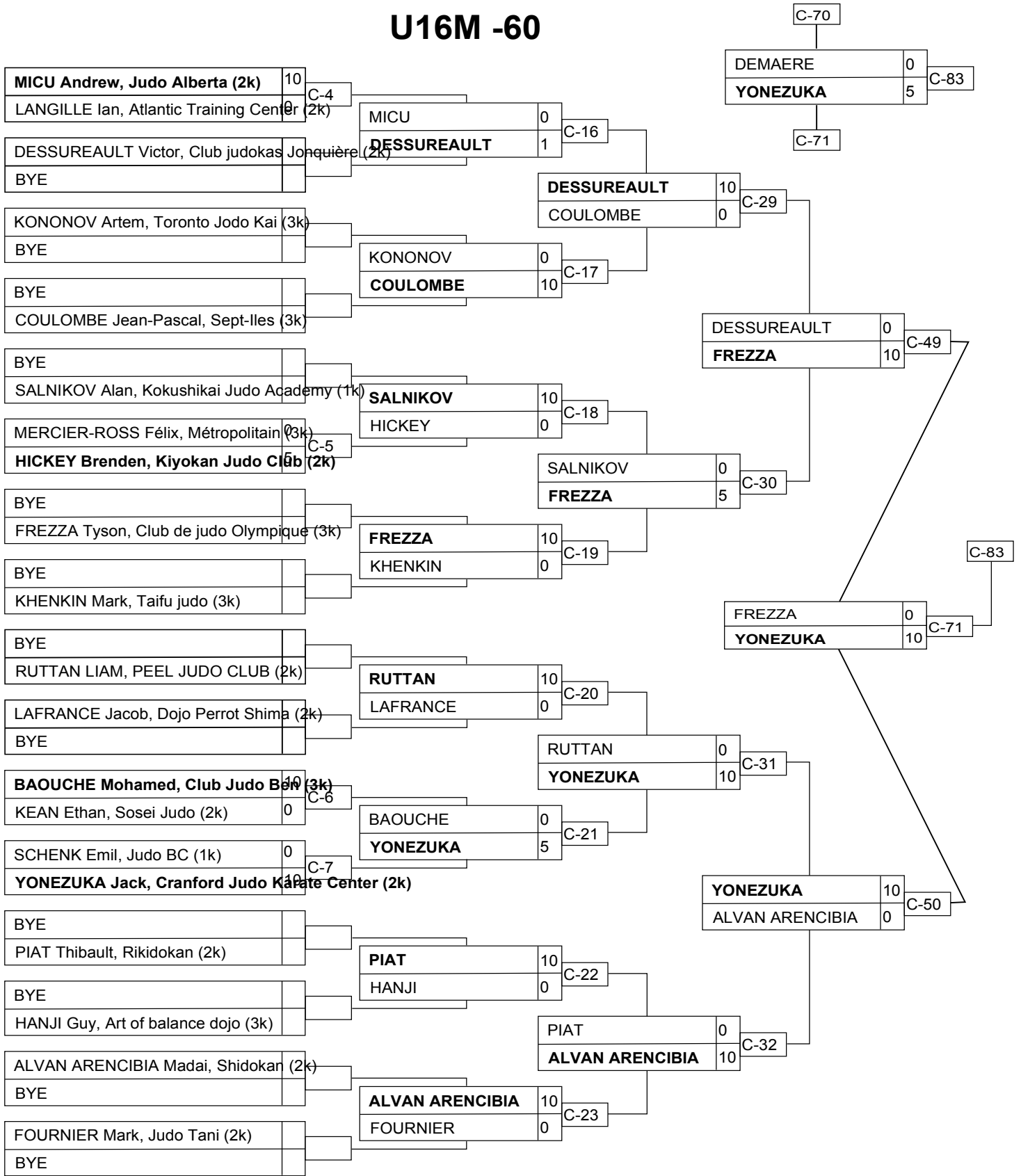



# U16M -60

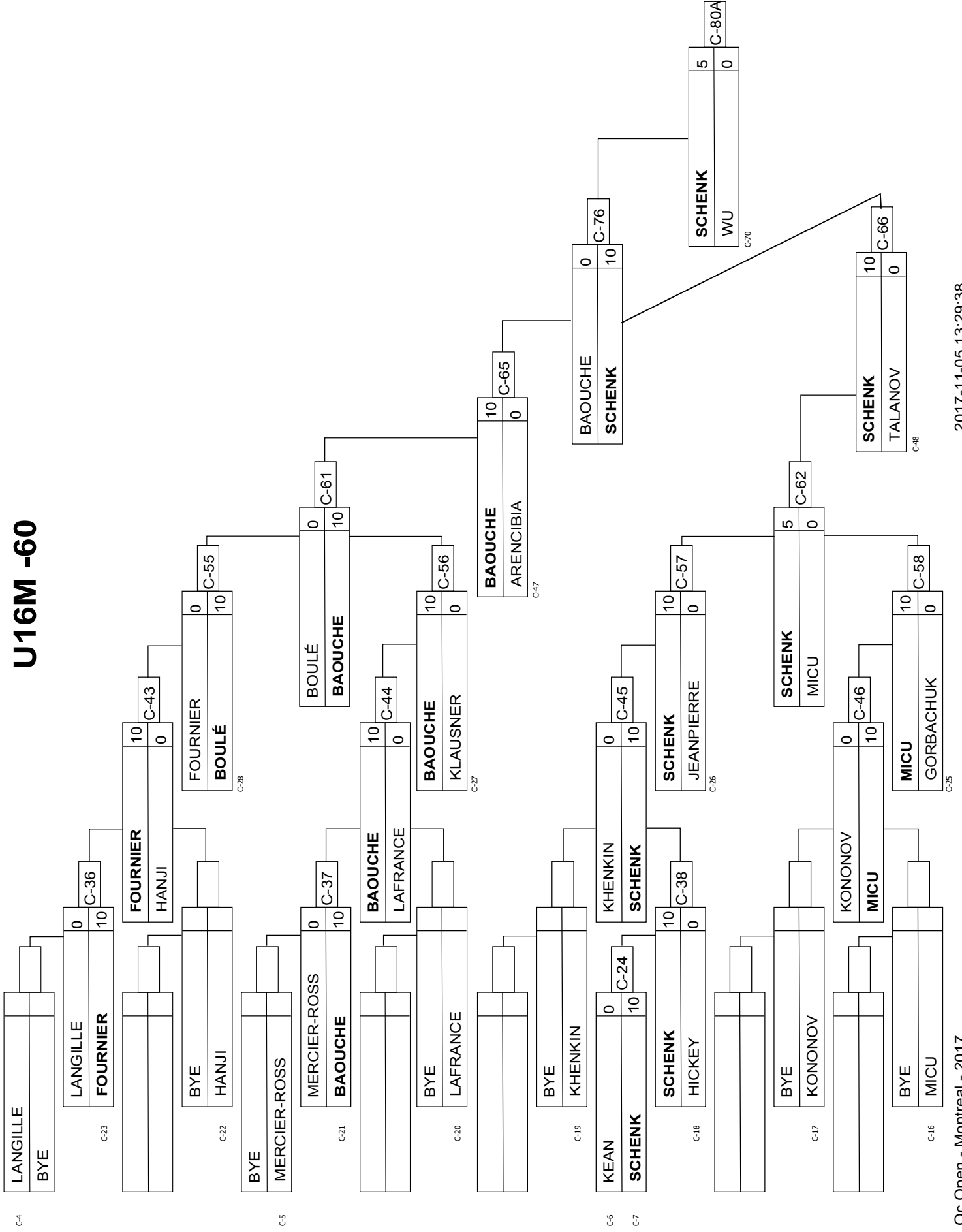

# U16M -66

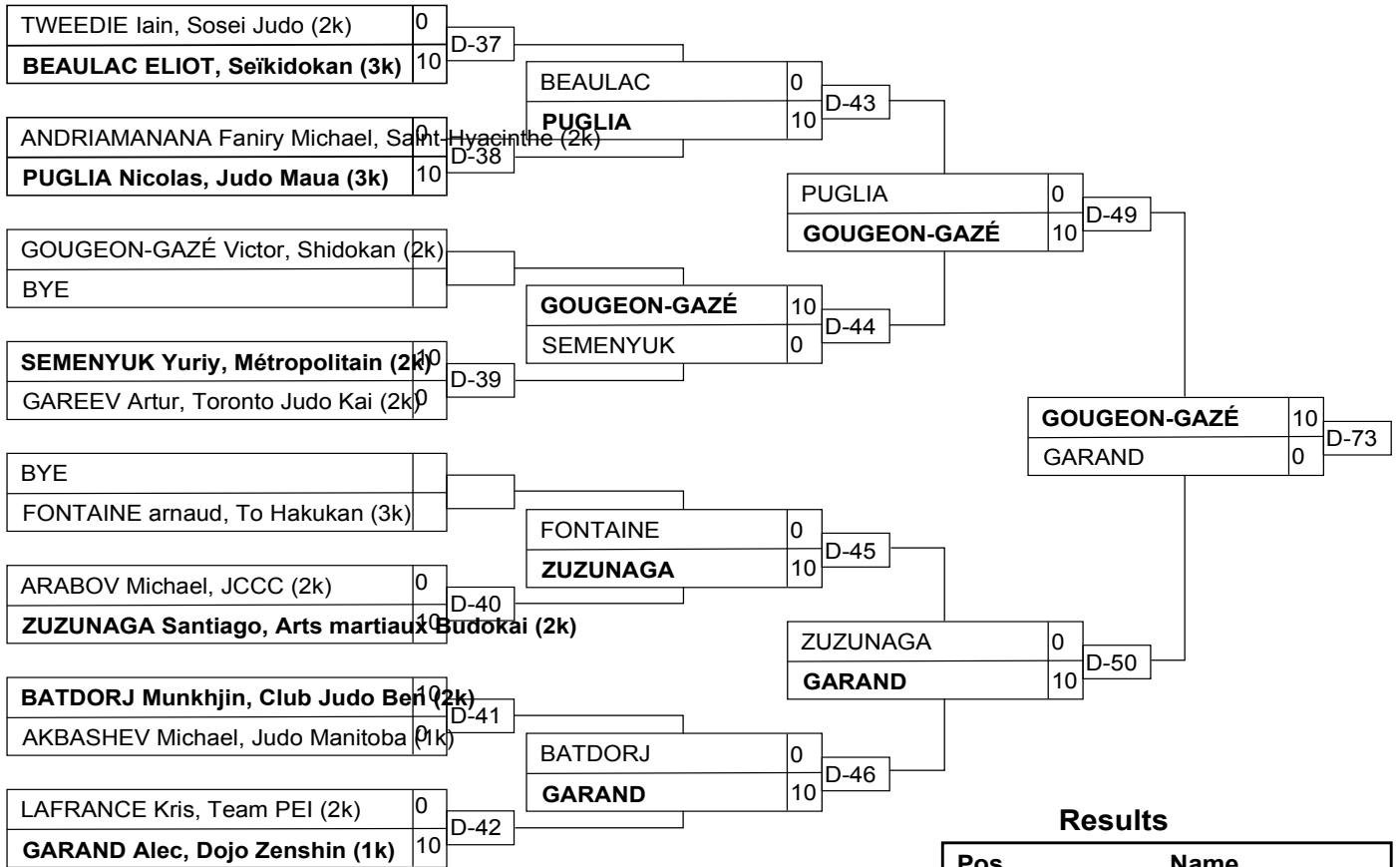

## Results

Pos	Name
1	GOUGEON-GAZÉ Victor, Shidokan (2k)
2	GARAND Alec, Dojo Zenshin (1k)
3	BATDORJ Munkhjin, Club Judo Ben (2k)
3	AKBASHEV Michael, Judo Manitoba (1k)

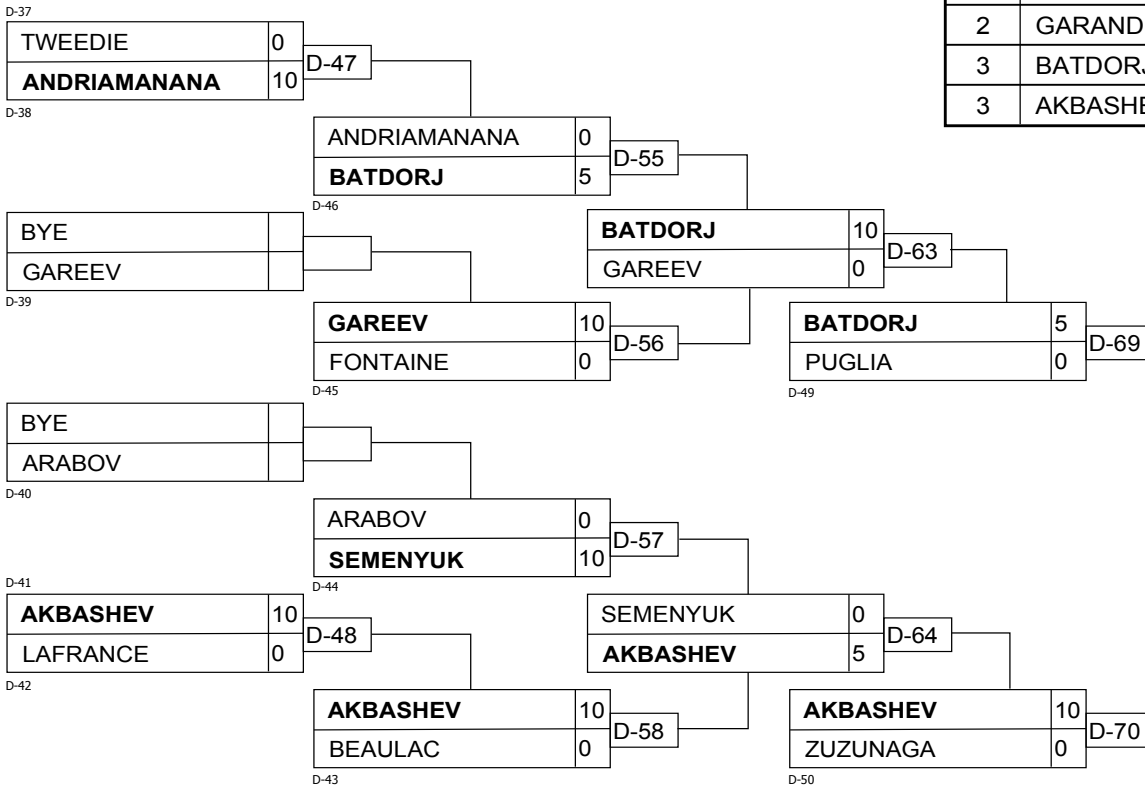

# U16M -73

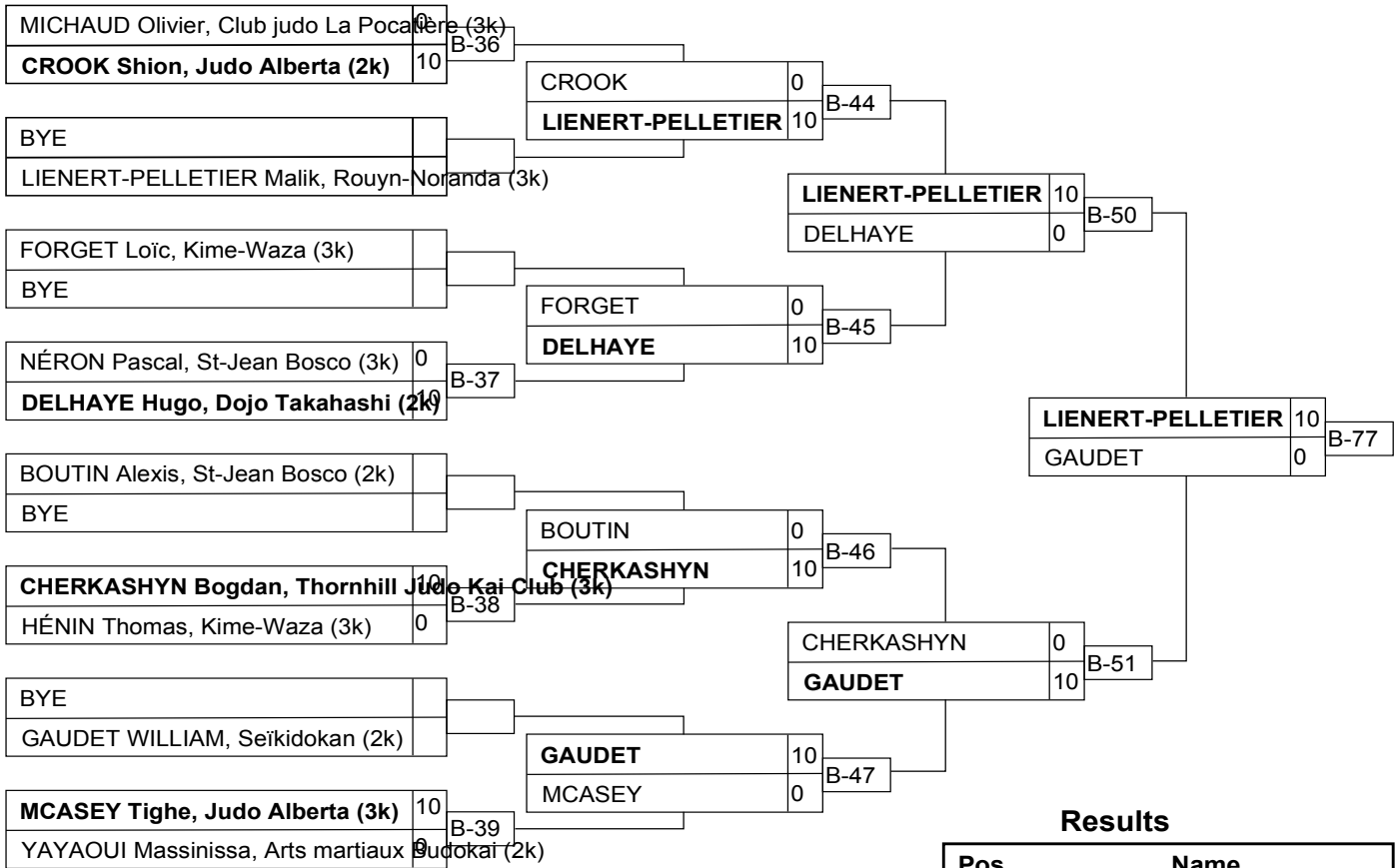

## Results

Pos	Name
1	LIENERT-PELLETIER Malik, Rouyn-Noranda (3k)
2	GAUDET WILLIAM, Seikidokan (2k)
3	MCASEY Tighe, Judo Alberta (3k)
3	CHERKASHYN Bogdan, Thornhill Judo Kai Club (3k)

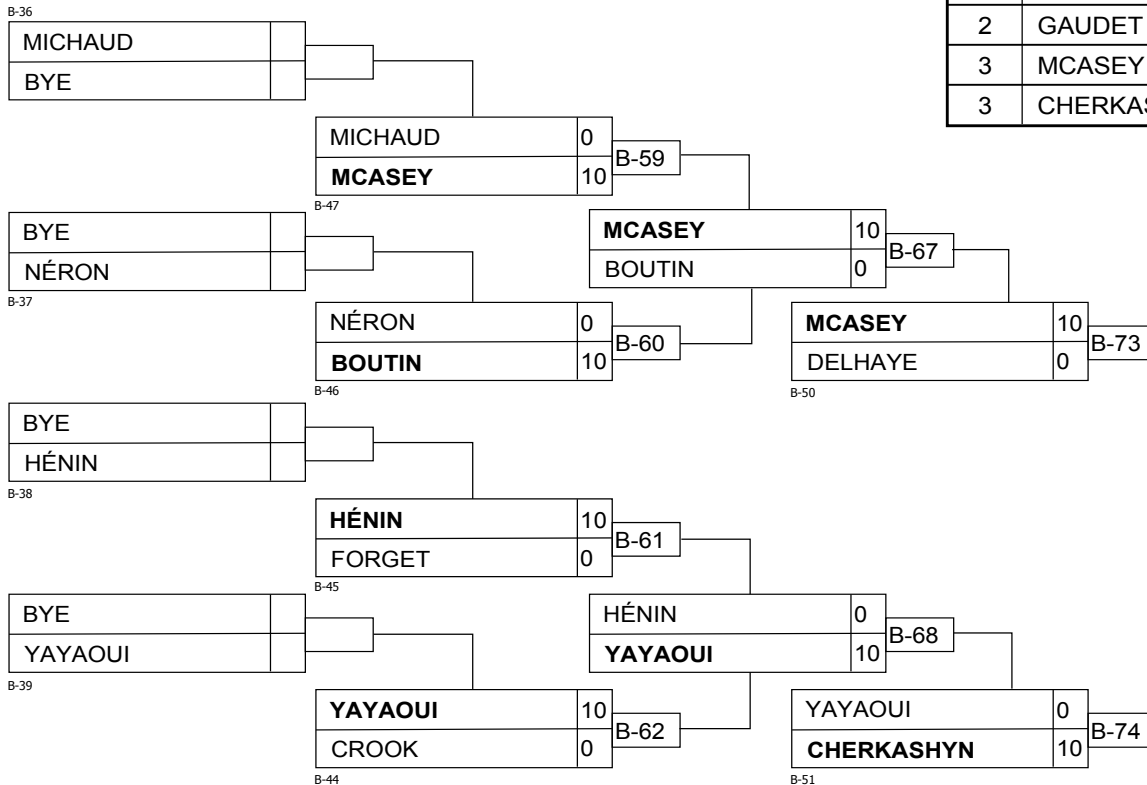

# U16M +73

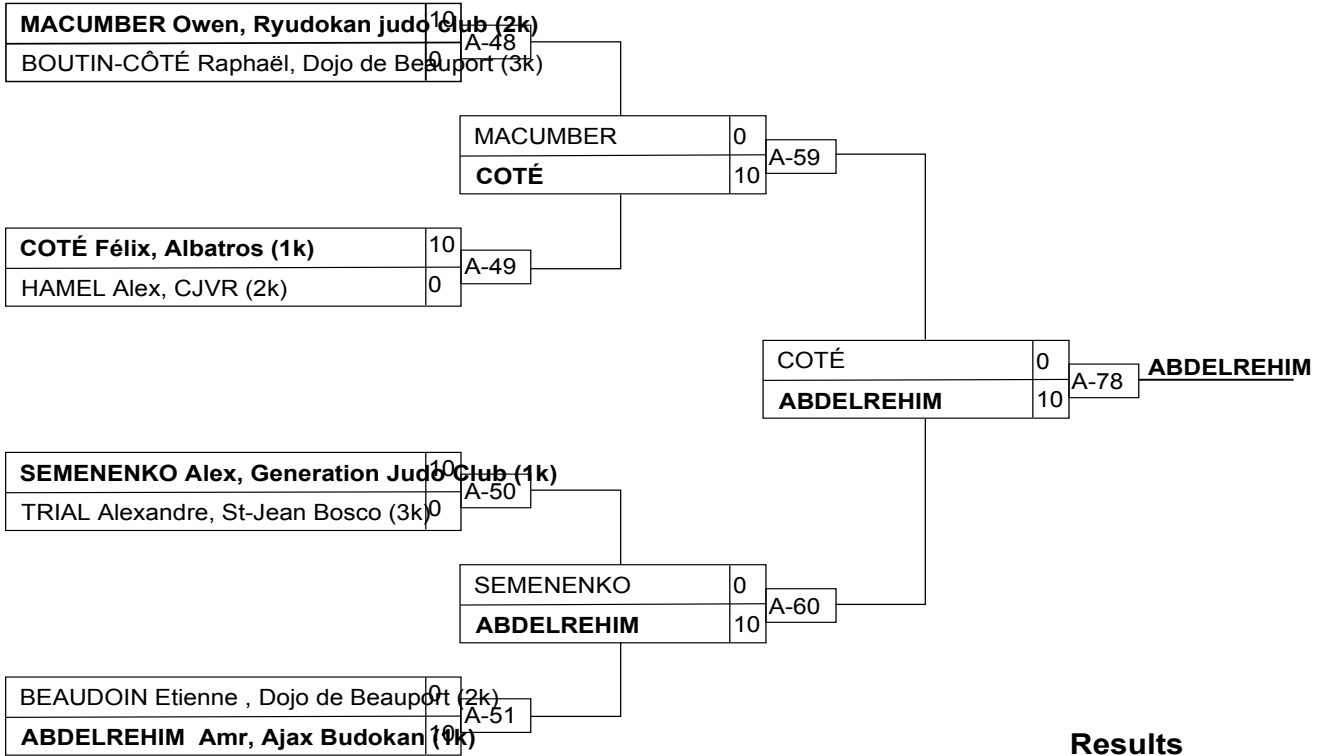

## Results

Pos	Name
1	ABDELREHIM Amr, Ajax Budokan (1k)
2	COTÉ Félix, Albatros (1k)
3	MACUMBER Owen, Ryudokan judo club
3	SEMENENKO Alex, Generation Judo Club

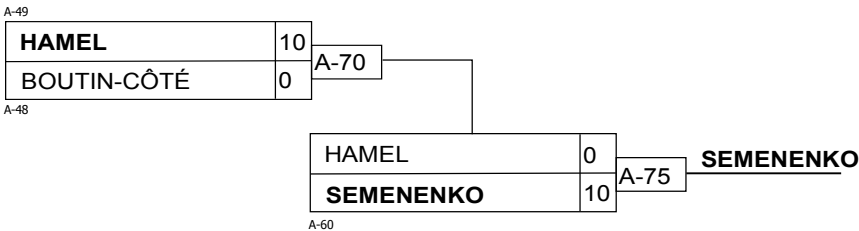
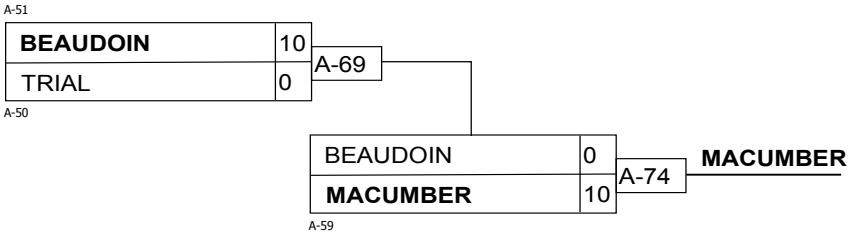

# U14F -40

## Compétiteurs/Competitors A

#	Nom/Name	Club	1	2	3	G/W	Pts	Pos
1	STRAKLEVSKI Cleea	ON	XX		10	1	10	2
2	AYOTTE Gabrielle	NB	5	XX	10	2	15	1
3	CÔTÉ Aurélie	QC			XX	0	0	3

## Matches/Matches A

Match	Blanc/White			Bleu/Blue	Rés/Res	Tmp/Tim	Code
F-17	STRAKLEVSKI Cleea	1	2	AYOTTE Gabrielle	0 - 5	3:00	WAZ
F-25	STRAKLEVSKI Cleea	1	3	CÔTÉ Aurélie	10 - 0	2:51	IPO
F-31	AYOTTE Gabrielle	2	3	CÔTÉ Aurélie	10 - 0	1:05	IPO

## Compétiteurs/Competitors B

#	Nom/Name	Club	4	5	6	G/W	Pts	Pos
4	TOSHKOV Catherine	QC	XX	10		1	10	2
5	MCCRISTALL Angelina	ON		XX		0	0	3
6	BOUYSSOU Celine	USA	5	10	XX	2	15	1

## Matches/Matches B

Match	Blanc/White			Bleu/Blue	Rés/Res	Tmp/Tim	Code
F-18	TOSHKOV Catherine	4	5	MCCRISTALL Angelina	10 - 0	1:35	IPO
F-26	TOSHKOV Catherine	4	6	BOUYSSOU Celine	0 - 5	3:00	WAZ
F-32	MCCRISTALL Angelina	5	6	BOUYSSOU Celine	0 - 10	0:43	IPO

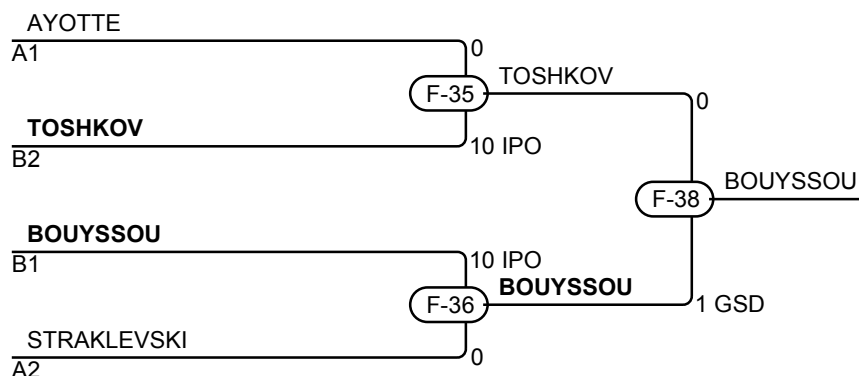

## Résultats/Results

Pos	Nom/Name
1	BOUYSSOU Celine, USA
2	TOSHKOV Catherine, QC
3	AYOTTE Gabrielle, NB
3	STRAKLEVSKI Cleea, ON



# U14F -44

## Compétiteurs/Competitors

#	Nom/Name	Club	1	2	3	4	5	G/W	Pts	Pos
1	BONIN Ariane	QC	XX					0	0	5
2	BERIAULT Genevieve	QC	5	XX				1	5	4
3	CILENTI Gianna	USA	10	10	XX	10		3	30	2
4	SAVARD Meagan	QC	10	10		XX		2	20	3
5	DESSUREAULT Olivia	QC	10	10	10	10	XX	4	40	1

## Matches/Matches

Match	Blanc/White			Bleu/Blue	Rés/Res	Tmp/Tim	Code
F-1	SAVARD Meagan	4	5	DESSUREAULT Olivia	0 - 10	1:36	IPO
F-2	BONIN Ariane	1	2	BERIAULT Genevieve	0 - 5	3:00	WAZ
F-7	<b>CILENTI Gianna</b>	3	4	SAVARD Meagan	10 - 0	2:38	IPO
F-8	BONIN Ariane	1	5	DESSUREAULT Olivia	0 - 10	0:06	IPO
F-13	BERIAULT Genevieve	2	3	CILENTI Gianna	0 - 10	2:29	IPO
F-14	BONIN Ariane	1	4	SAVARD Meagan	0 - 10	0:47	IPO
F-19	CILENTI Gianna	3	5	DESSUREAULT Olivia	0 - 10	0:08	IPO
F-20	BERIAULT Genevieve	2	4	SAVARD Meagan	0 - 10	0:58	IPO
F-27	BONIN Ariane	1	3	CILENTI Gianna	0 - 10	0:39	IPO
F-28	BERIAULT Genevieve	2	5	DESSUREAULT Olivia	0 - 10	1:00	IPO

## Résultats/Results

Pos	Nom/Name
1	DESSUREAULT Olivia, QC
2	CILENTI Gianna, USA
3	SAVARD Meagan, QC
4	BERIAULT Genevieve, QC

# U14F -52

## Compétiteurs/Competitors

#	Nom/Name	Club	1	2	3	G/W	Pts	Pos
1	DOUCET Brooke	PE	XX			0	0	3
2	IKENE Ioundja	QC	10	XX		1	10	2
3	BURT Kiera	ON	10	5	XX	2	15	1

## Matches/Matches

Match	Blanc/White			Bleu/Blue	Rés/Res	Tmp/Tim	Code
G-15	DOUCET Brooke	1	2	IKENE Ioundja	0 - 10	0:56	IPO
G-22	DOUCET Brooke	1	3	BURT Kiera	0 - 10	0:43	IPO
G-27	IKENE Ioundja	2	3	BURT Kiera	0 - 5	4:28	GSW

## Résultats/Results

Pos	Nom/Name
1	BURT Kiera, ON
2	IKENE Ioundja, QC

# U14M -31

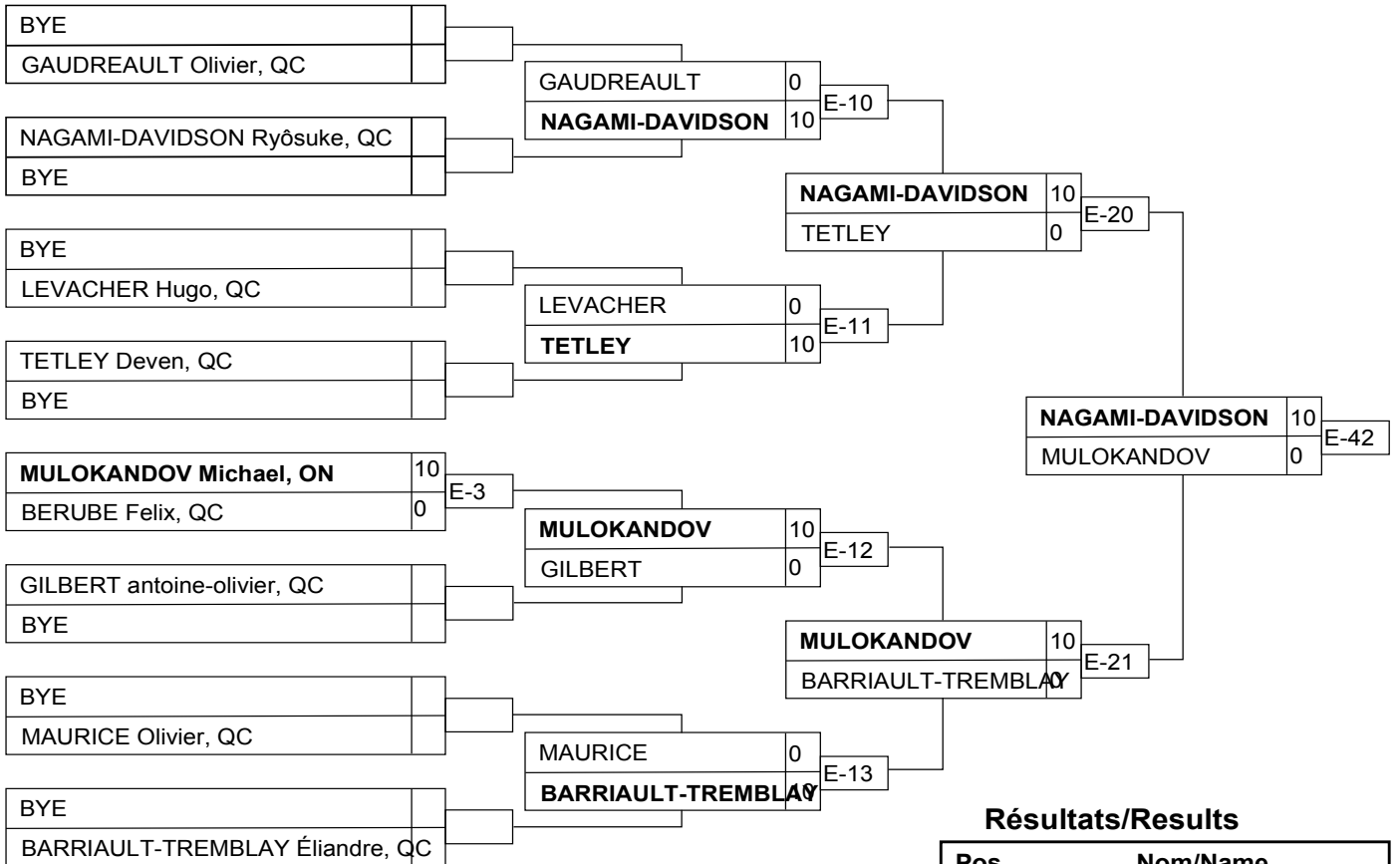

## Résultats/Results

Pos	Nom/Name
1	NAGAMI-DAVIDSON Ryôsuke, QC
2	MULO KANDOV Michael, ON
3	TETLEY Deven, QC
3	GAUDREULT Olivier, QC

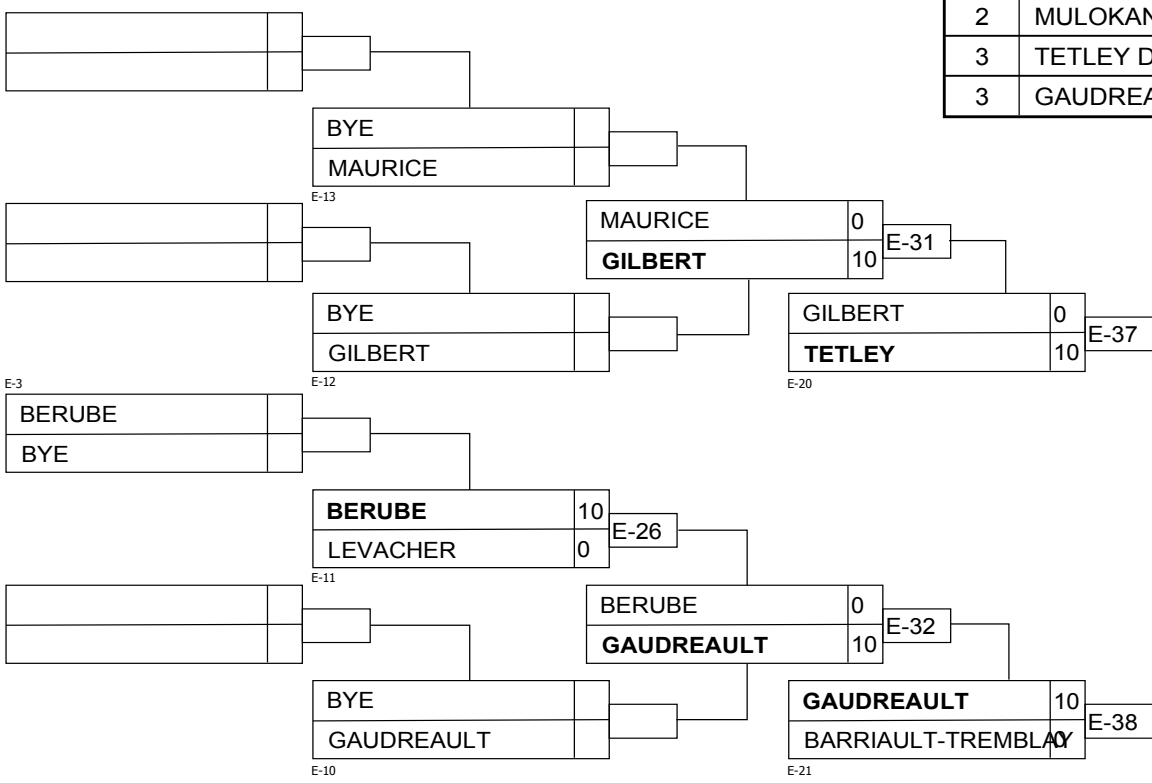

# U14M -34

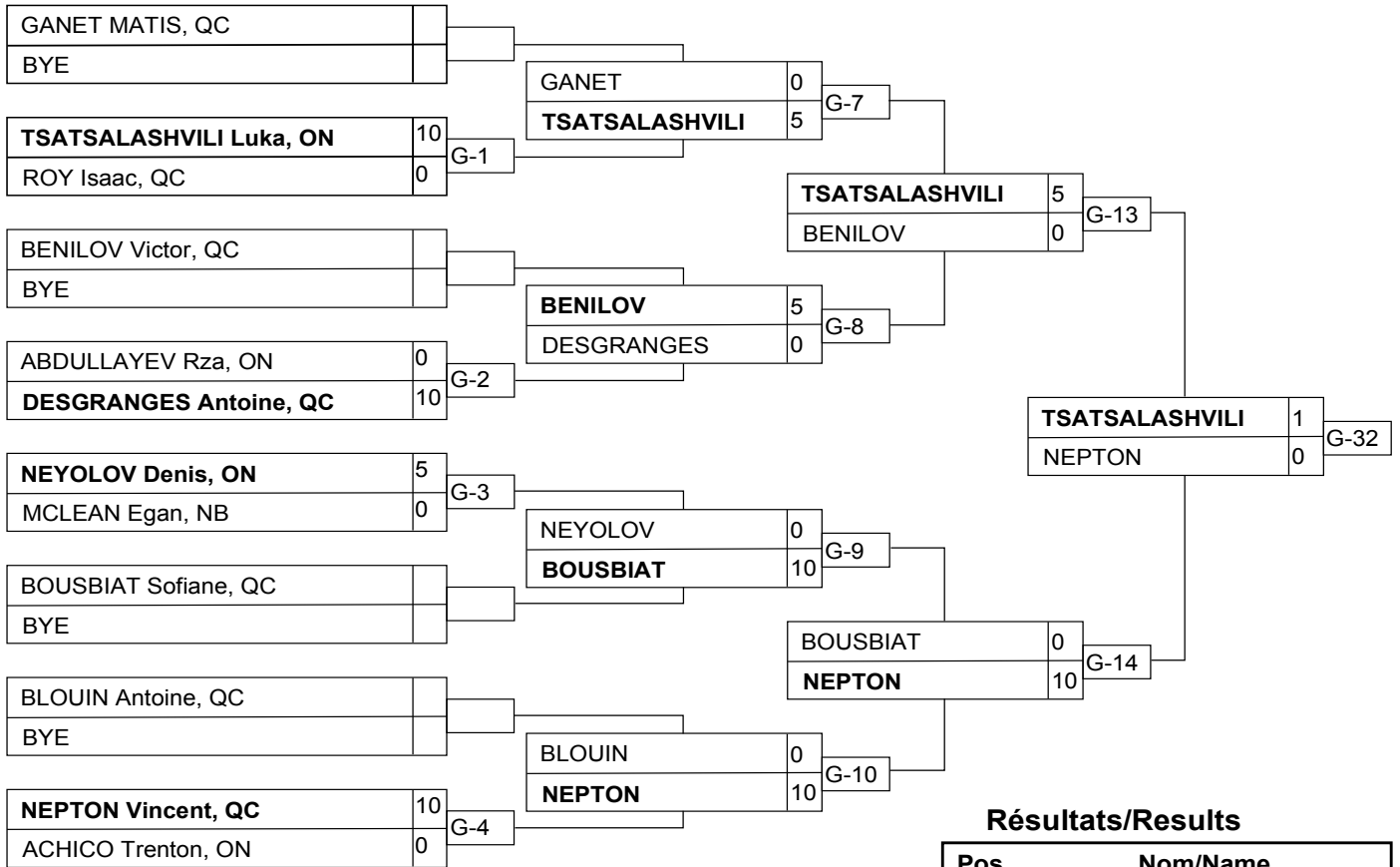

## Résultats/Results

Pos	Nom/Name
1	TSATSALASHVILI Luka, ON
2	NEPTON Vincent, QC
3	ABDULLAYEV Rza, ON
3	GANET MATIS, QC

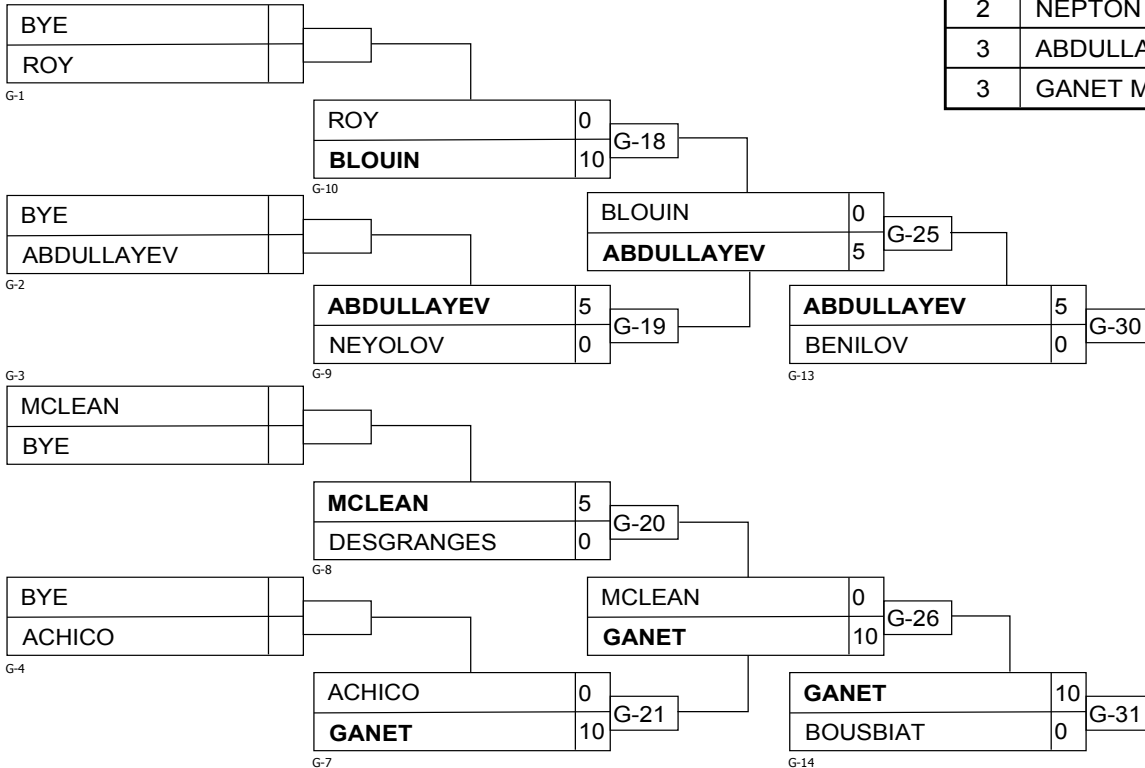

# U14M -42

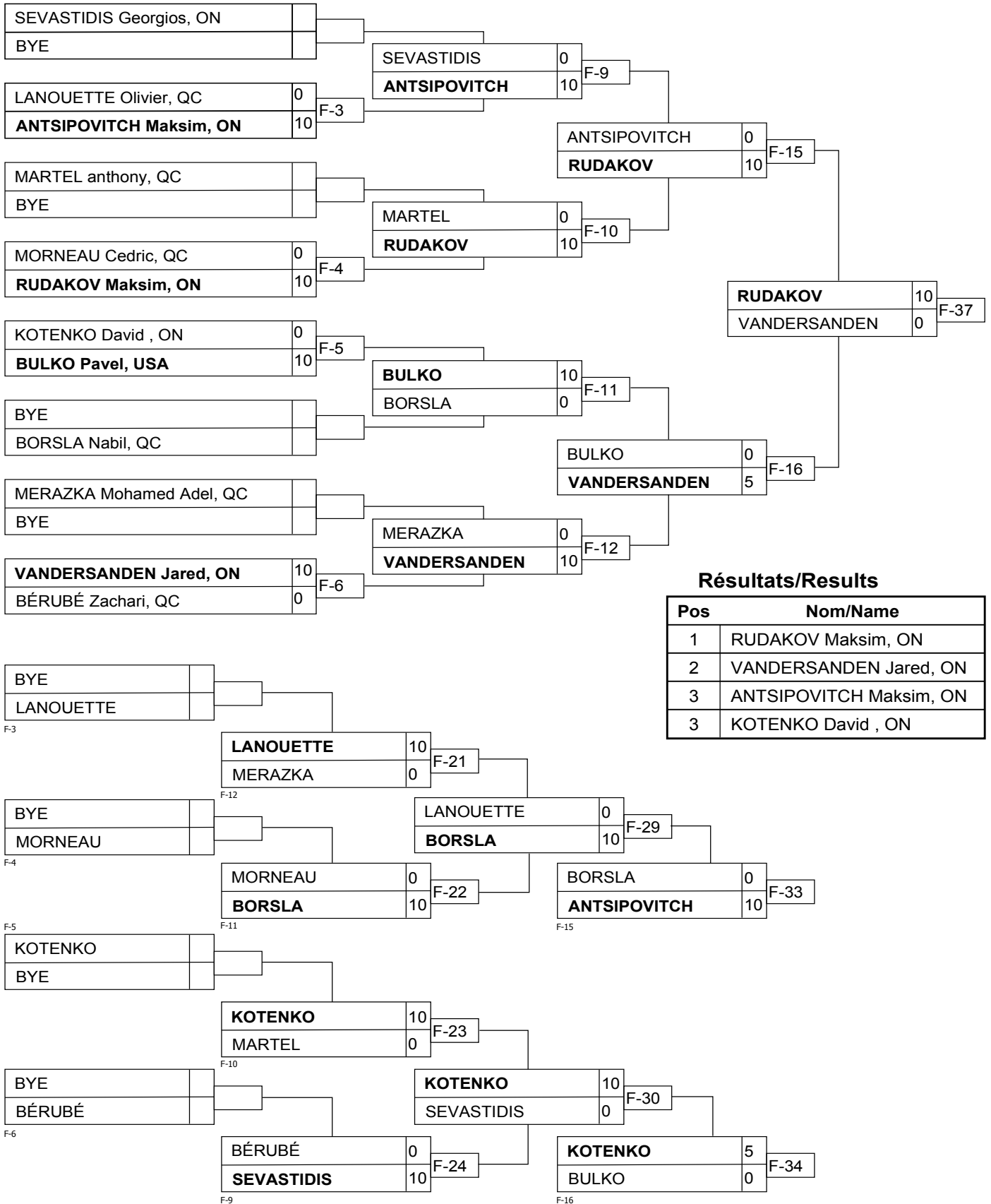

# U14M -46

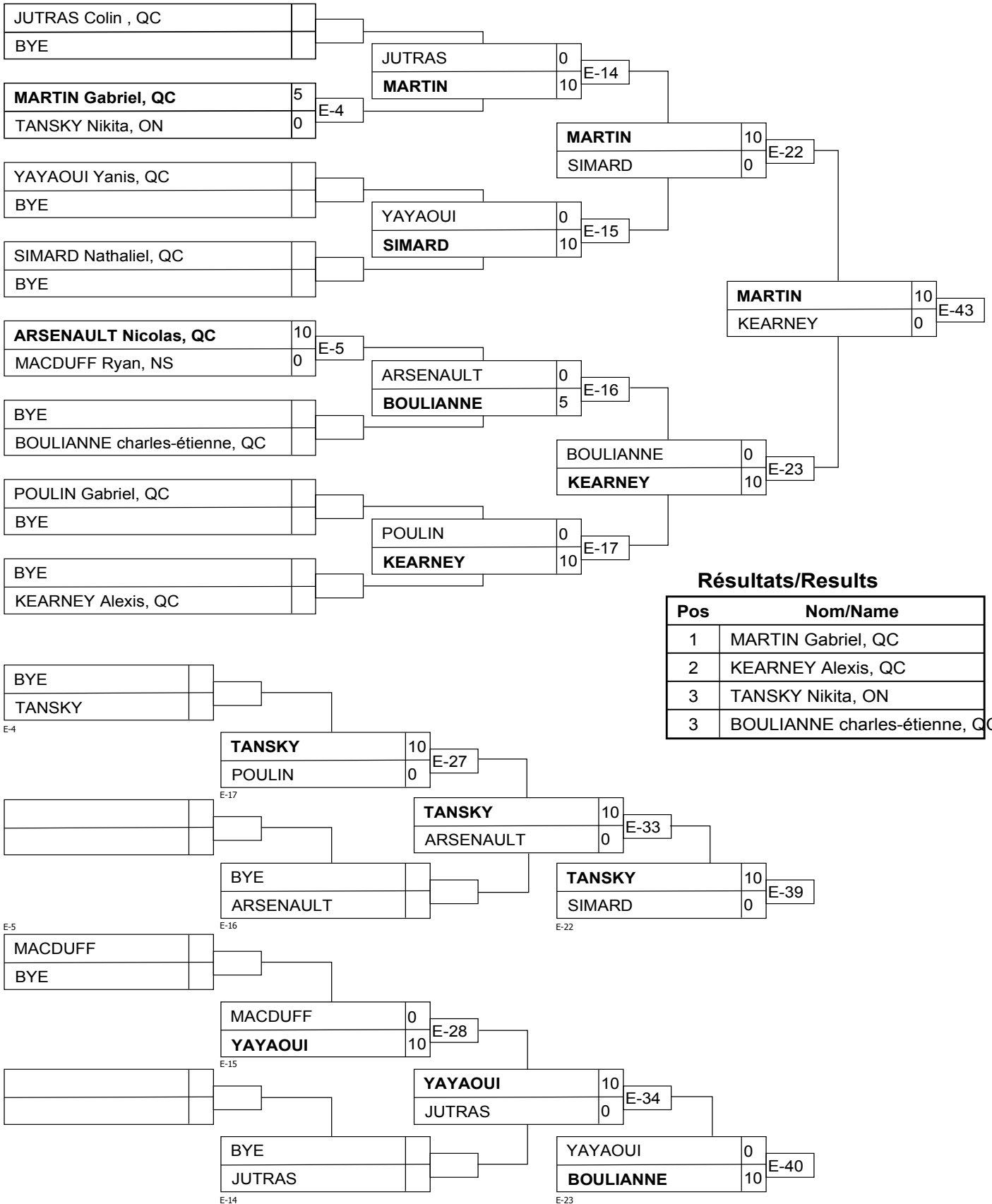

# U14M -50

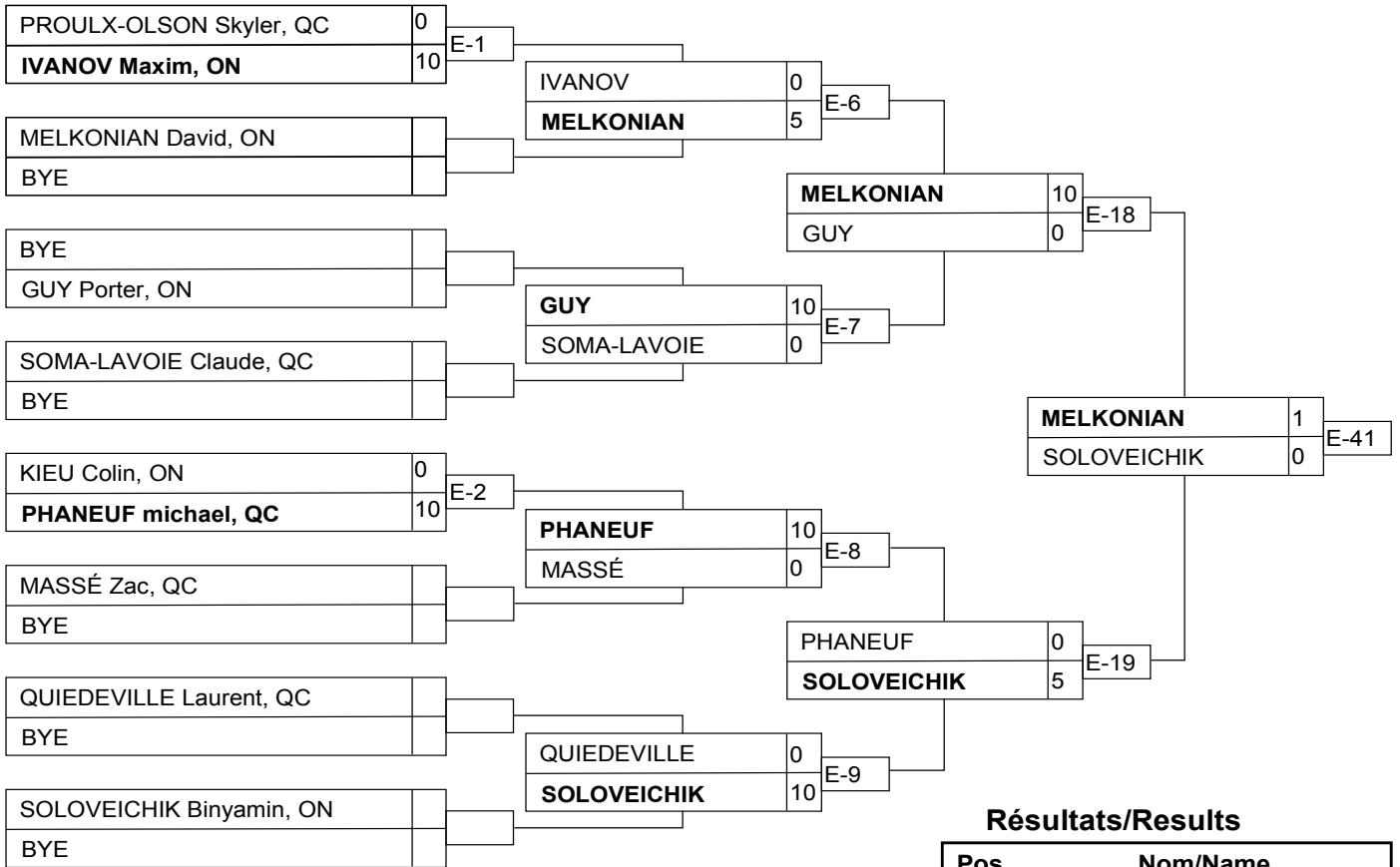

## Résultats/Results

Pos	Nom/Name
1	MELKONIAN David, ON
2	SOLOVEICHIK Binyamin, ON
3	QUIEDEVILLE Laurent, QC
3	PHANEUF michael, QC

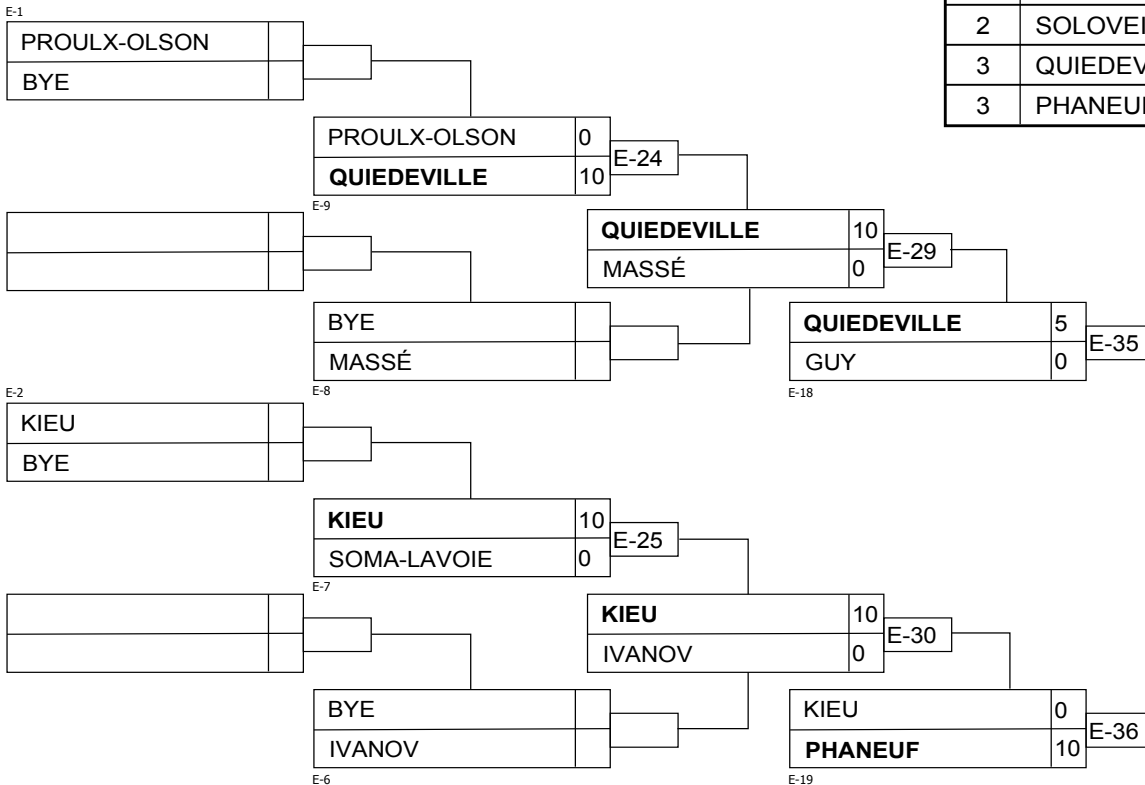

# U14M -66

## Compétiteurs/Competitors

#	Nom/Name	Club	1	2	3	4	5	G/W	Pts	Pos
1	NGOMBI Jérémie	QC	XX	5	5		10	3	20	2
2	DURAND Jeremy	QC		XX	1		10	2	11	3
3	SHAHGALDI Maani	QC			XX		10	1	10	4
4	BLACKBURN David	QC	10	10	10	XX	10	4	40	1
5	LAVALLEE Clément	QC					XX	0	0	5

## Matches/Matches

Match	Blanc/White			Bleu/Blue	Rés/Res	Tmp/Tim	Code
G-5	<b>BLACKBURN David</b>	4	5	LAVALLEE Clément	10 - 0	1:19	IPO
G-6	<b>NGOMBI Jérémie</b>	1	2	DURAND Jeremy	5 - 0	3:00	WAZ
G-11	SHAHGALDI Maani	3	4	<b>BLACKBURN David</b>	0 - 10	0:10	IPO
G-12	<b>NGOMBI Jérémie</b>	1	5	LAVALLEE Clément	10 - 0	1:29	IPO
G-16	<b>DURAND Jeremy</b>	2	3	SHAHGALDI Maani	1 - 0	3:59	GSD
G-17	NGOMBI Jérémie	1	4	<b>BLACKBURN David</b>	0 - 10	1:35	IPO
G-23	<b>SHAHGALDI Maani</b>	3	5	LAVALLEE Clément	10 - 0	0:01	FUS
G-24	DURAND Jeremy	2	4	<b>BLACKBURN David</b>	0 - 10	0:25	IPO
G-28	<b>NGOMBI Jérémie</b>	1	3	SHAHGALDI Maani	5 - 0	3:22	GSW
G-29	<b>DURAND Jeremy</b>	2	5	LAVALLEE Clément	10 - 0	0:01	FUS

## Résultats/Results

Pos	Nom/Name
1	BLACKBURN David, QC
2	NGOMBI Jérémie, QC
3	DURAND Jeremy, QC
4	SHAHGALDI Maani , QC



# U16F -40

## Compétiteurs/Competitors

#	Nom/Name	Club	1	2	3	G/W	Pts	Pos
1	FREY Caitlin	USA	XX	10	10	2	20	1
2	LAPINTE Sophie	QC		XX	10	1	10	2
3	ENMAN Lydia	PE			XX	0	0	3

## Matches/Matches

Match	Blanc/White			Bleu/Blue	Rés/Res	Tmp/Tim	Code
E-68	FREY Caitlin	1	2	LAPINTE Sophie	10 - 0	2:17	HAN
E-73	FREY Caitlin	1	3	ENMAN Lydia	10 - 0	1:32	IPO
E-76	LAPINTE Sophie	2	3	ENMAN Lydia	10 - 0	0:42	IPO

## Résultats/Results

Pos	Nom/Name
1	FREY Caitlin, USA
2	LAPINTE Sophie, QC

# U16F -44

## Compétiteurs/Competitors

#	Nom/Name	Club	1	2	3	4	5	G/W	Pts	Pos
1	SEMYROZUM Anastasiya	QC	XX	10		10	10	3	30	1
2	TSYRLIN Anat	USA		XX		5	1	2	6	4
3	KASTULIN Veronica	ON	10	5	XX	5		3	20	2
4	FOREST lana	QC				XX		0	0	5
5	MANAILA Rebeca	QC			5	10	XX	2	15	3

## Matches/Matches

Match	Blanc/White			Bleu/Blue	Rés/Res	Tmp/Tim	Code
G-33	FOREST lana	4	5	MANAILA Rebeca	0 - 10	1:11	IPO
G-34	SEMYROZUM Anastasiya	1	2	TSYRLIN Anat	10 - 0	0:01	FUS
G-48	KASTULIN Veronica	3	4	FOREST lana	5 - 0	3:00	WAZ
G-49	SEMYROZUM Anastasiya	1	5	MANAILA Rebeca	10 - 0	2:14	IPO
G-56	TSYRLIN Anat	2	3	KASTULIN Veronica	0 - 5	3:35	GSW
G-57	SEMYROZUM Anastasiya	1	4	FOREST lana	10 - 0	2:39	HAN
G-65	KASTULIN Veronica	3	5	MANAILA Rebeca	0 - 5	3:35	GSW
G-66	TSYRLIN Anat	2	4	FOREST lana	5 - 0	3:00	WAZ
G-73	SEMYROZUM Anastasiya	1	3	KASTULIN Veronica	0 - 10	4:21	GSI
G-74	TSYRLIN Anat	2	5	MANAILA Rebeca	1 - 0	6:23	GSD

## Résultats/Results

Pos	Nom/Name
1	SEMYROZUM Anastasiya , QC
2	KASTULIN Veronica, ON
3	MANAILA Rebeca, QC
4	TSYRLIN Anat, USA

# U16F -52

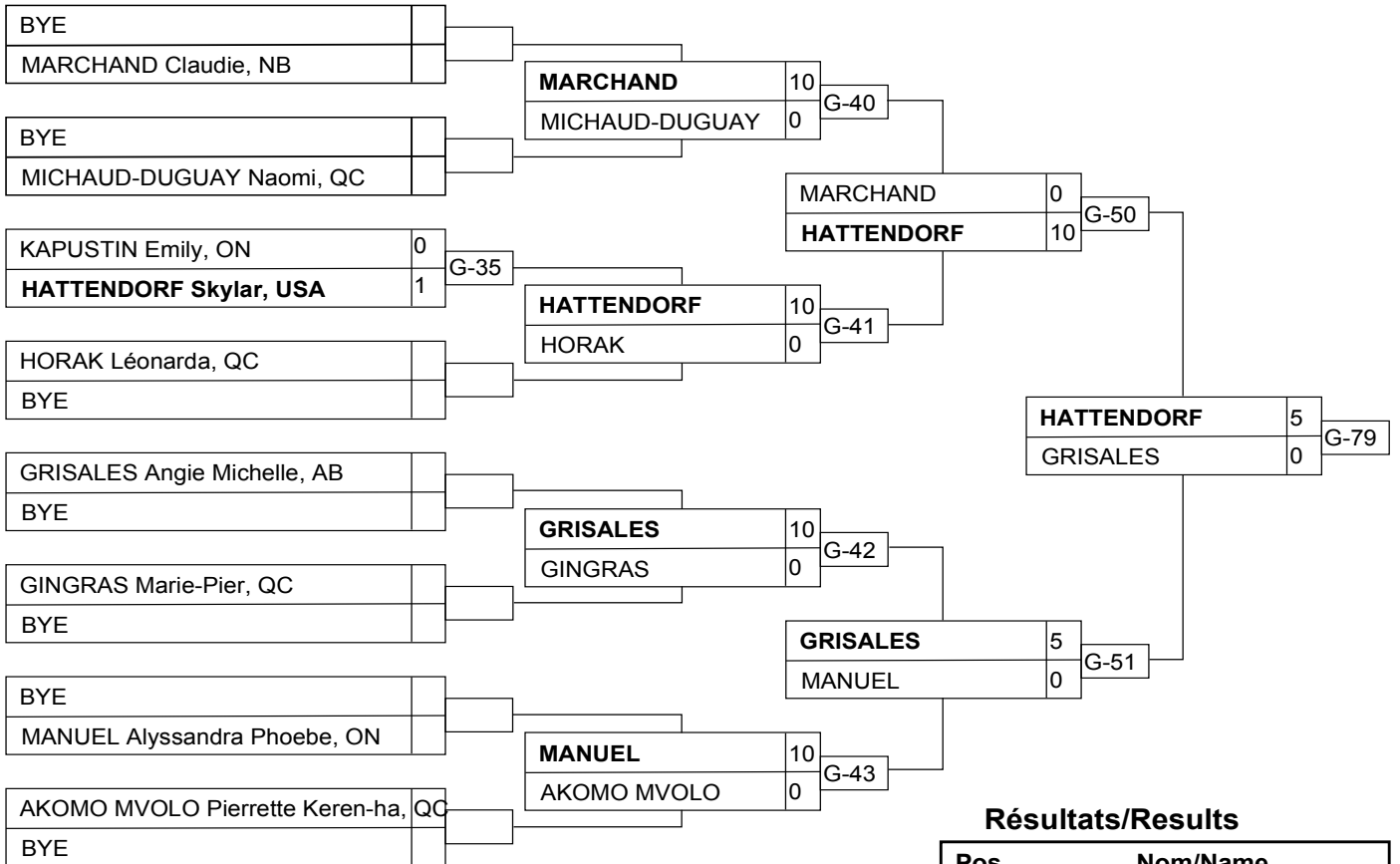

## Résultats/Results

Pos	Nom/Name
1	HATTENDORF Skylar, USA
2	GRISALES Angie Michelle, AB
3	KAPUSTIN Emily, ON
3	MANUEL Alyssandra Phoebe, ON

# U16F -57

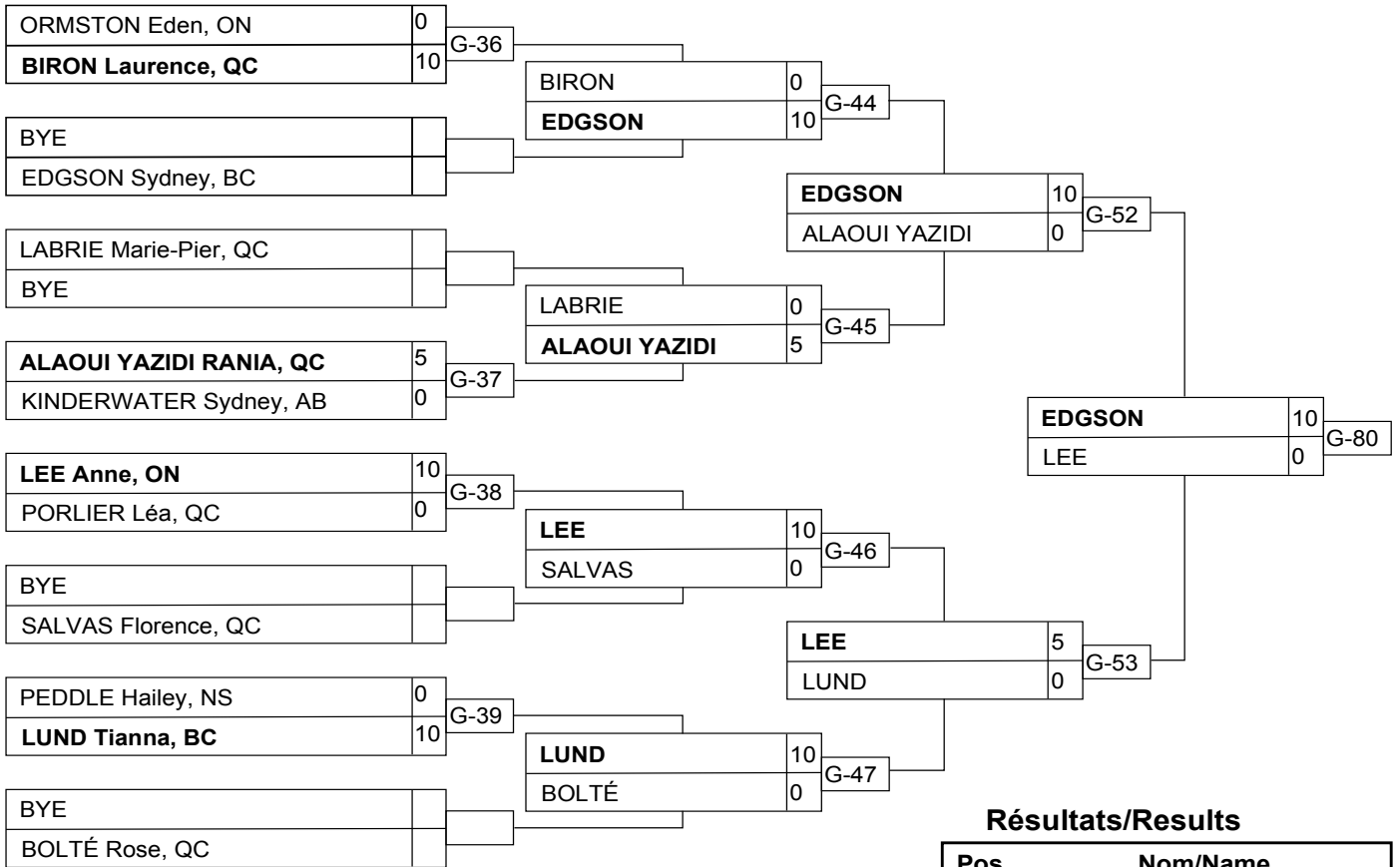

## Résultats/Results

Pos	Nom/Name
1	EDGSON Sydney, BC
2	LEE Anne, ON
3	SALVAS Florence, QC
3	BIRON Laurence, QC

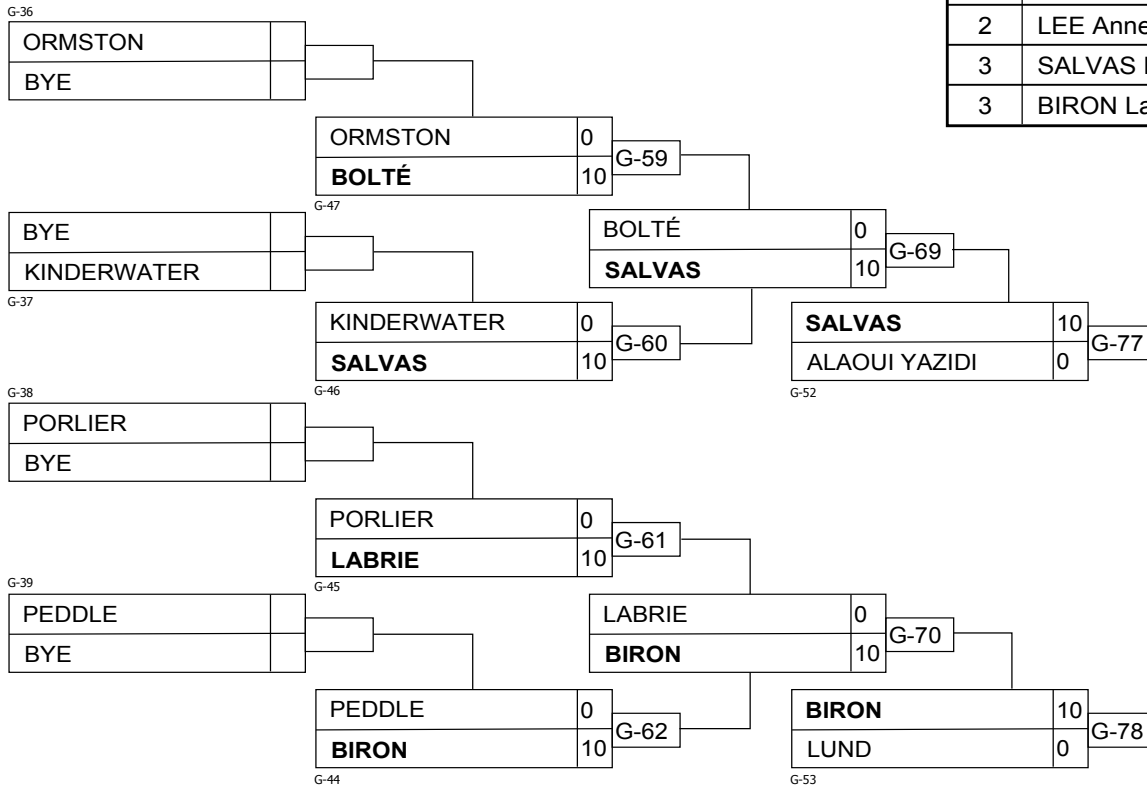

# U16F -70

## Compétiteurs/Competitors

#	Nom/Name	Club	1	2	1	2	1	2	G/W	Pts	Pos
1	MOZHAEV Ekaterina	ON	XX	5	XX	10	XX		2	15	1
2	SAHRAOUI Maya	QC		XX		XX		XX	0	0	2

## Matches/Matches

Match	Blanc/White			Bleu/Blue	Rés/Res	Tmp/Tim	Code
F-75	MOZHAEV Ekaterina	1	2	SAHRAOUI Maya	5 - 0	3:15	GSW
F-80	SAHRAOUI Maya	2	1	MOZHAEV Ekaterina	0 - 10	0:53	IPO
F-83	MOZHAEV Ekaterina	1	2	SAHRAOUI Maya			

## Résultats/Results

Pos	Nom/Name
1	MOZHAEV Ekaterina, ON

# U16F +70

## Compétiteurs/Competitors

#	Nom/Name	Club	1	2	3	4	G/W	Pts	Pos
1	TOWNSEND Emilie	NS	XX				0	0	4
2	KEAYS Janessa	SK	5	XX			1	5	3
3	DOUGLAS Asia	ON	10	10	XX	10	3	30	1
4	LEFEBVRE Élodie	QC	10	10		XX	2	20	2

## Matches/Matches

Match	Blanc/White			Bleu/Blue	Rés/Res	Tmp/Tim	Code
G-54	TOWNSEND Emilie	1	2	KEAYS Janessa	0 - 5	3:00	WAZ
G-55	<b>DOUGLAS Asia</b>	3	4	LEFEBVRE Élodie	10 - 0	0:03	IPO
G-63	TOWNSEND Emilie	1	3	<b>DOUGLAS Asia</b>	0 - 10	0:29	IPO
G-64	KEAYS Janessa	2	4	<b>LEFEBVRE Élodie</b>	0 - 10	2:07	IPO
G-71	TOWNSEND Emilie	1	4	<b>LEFEBVRE Élodie</b>	0 - 10	0:34	IPO
G-72	KEAYS Janessa	2	3	<b>DOUGLAS Asia</b>	0 - 10	0:07	IPO

## Résultats/Results

Pos	Nom/Name
1	DOUGLAS Asia, ON
2	LEFEBVRE Élodie, QC
3	KEAYS Janessa, SK

# U16M -42

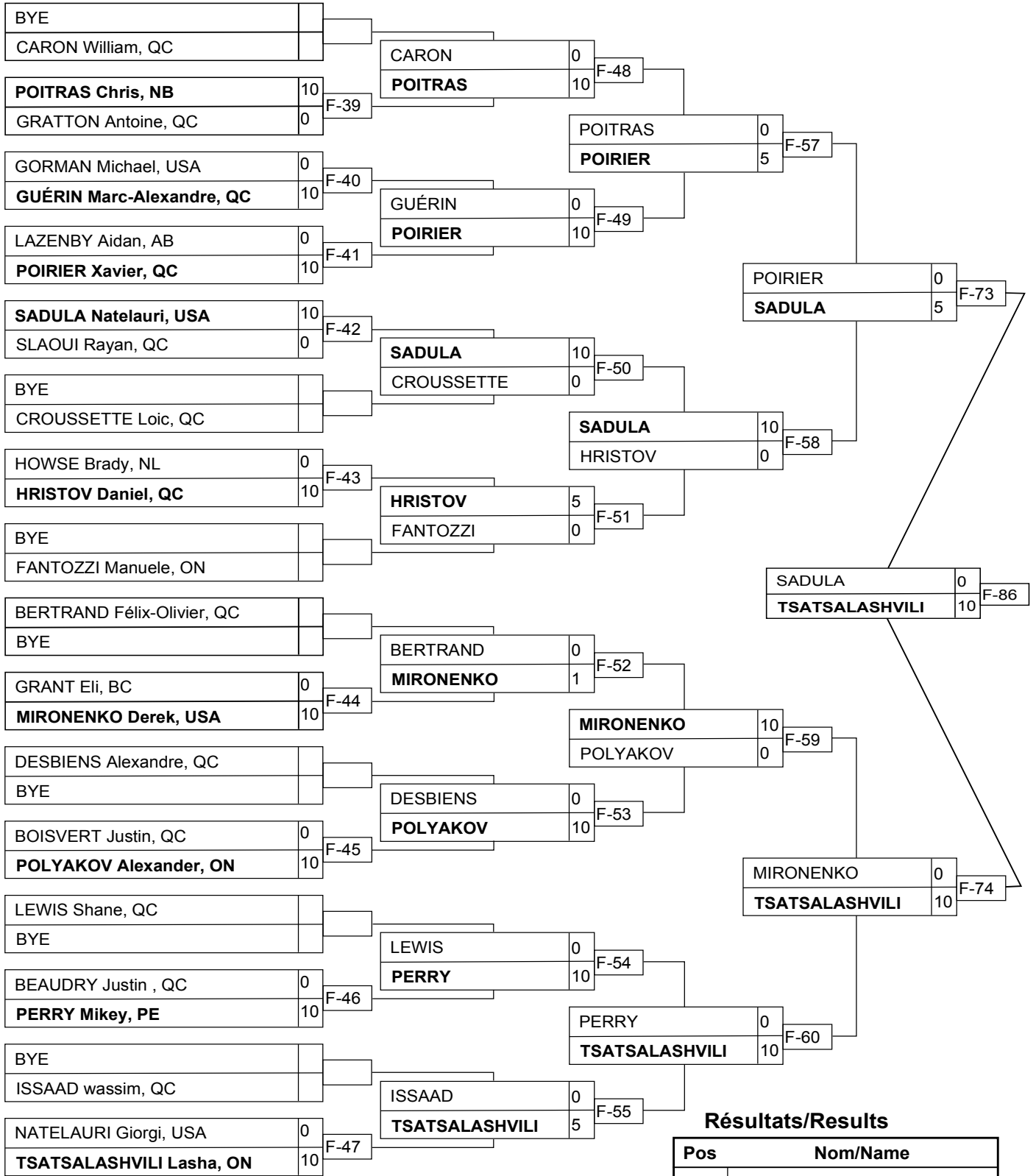

## Résultats/Results

Pos	Nom/Name
1	TSATSALASHVILI Lasha, ON
2	SADULA Natelauri, USA
3	PERRY Mikey, PE
3	BERTRAND Félix-Olivier, QC

# U16M -42

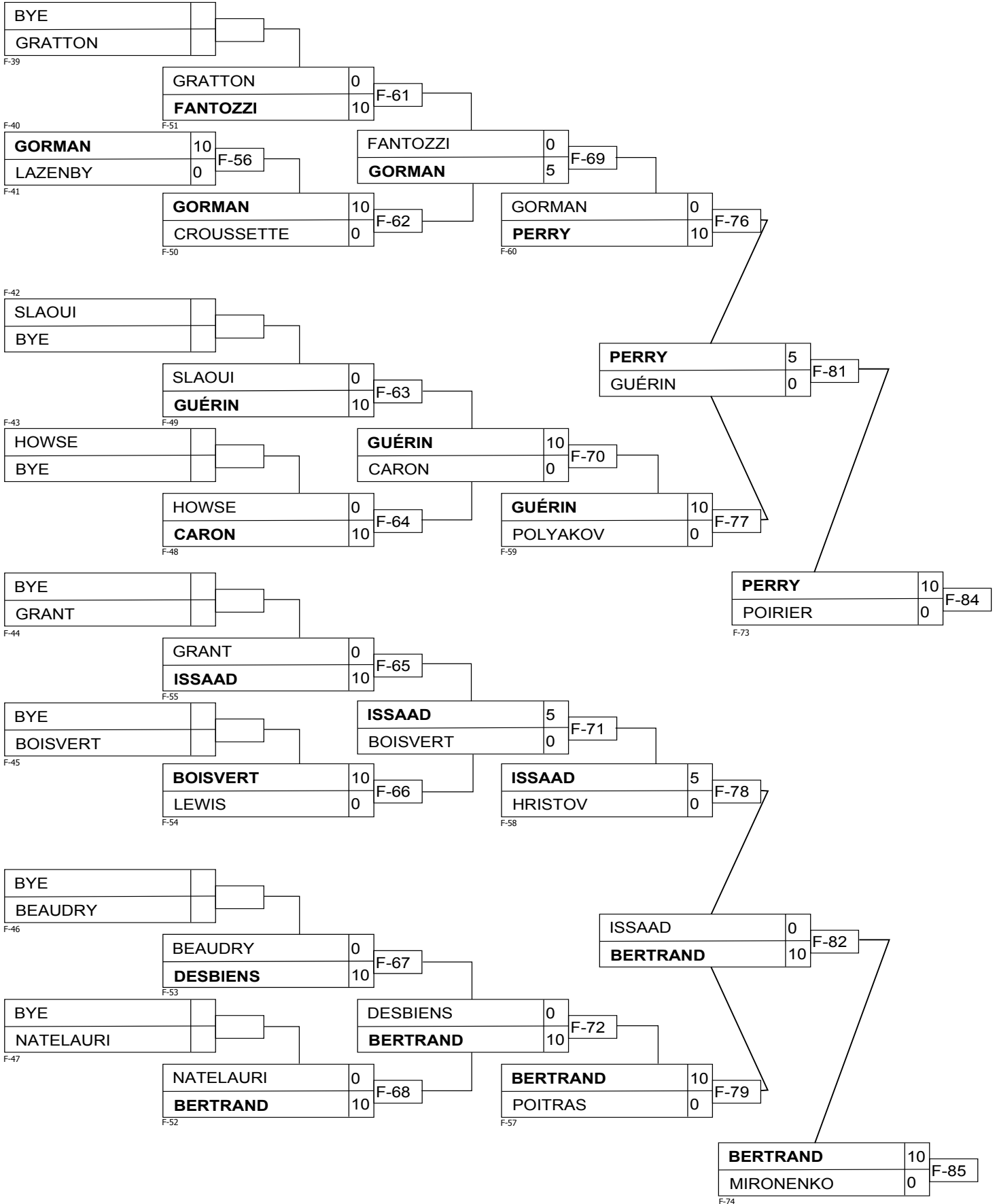



# U16M -50

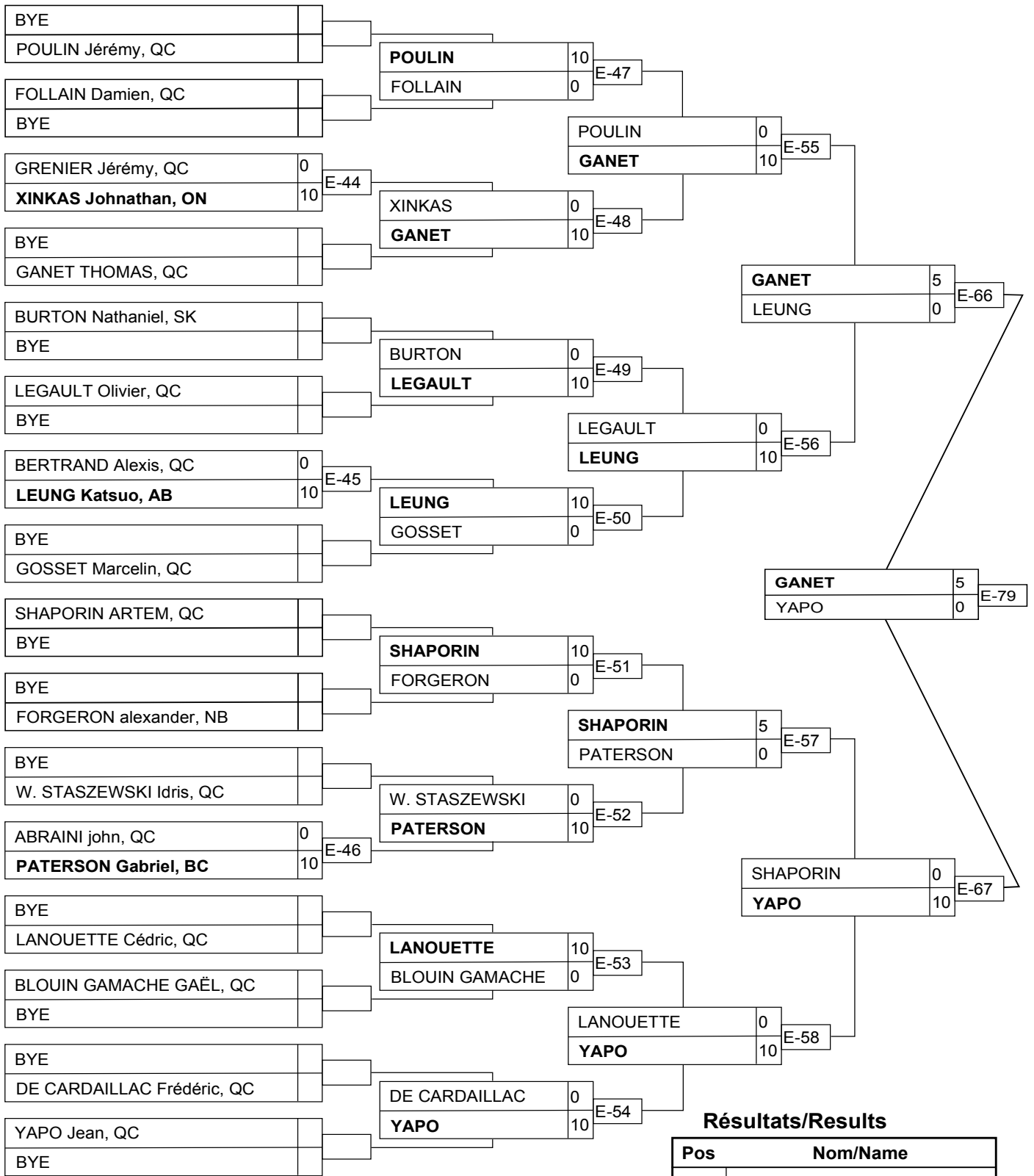

## Résultats/Results

Pos	Nom/Name
1	GANET THOMAS, QC
2	YAPO Jean, QC
3	LEUNG Katsuo, AB
3	LEGAULT Olivier, QC

# U16M -50

