

U14 Female -40kg



Competitors/Compétiteurs

#	Name/Nom	Grade	Club	1	2	3	W/G	Pts	Pos
1	LANG Melody	orange	Seiei Dojo	XX			0	0	3
2	LI Nashi	orange	Seiei Dojo	5	XX	10	2	15	1
3	AU Megan	green	BC/Peak Judo Club	10		XX	1	10	2

Matches/Matches

Match	White/Blanc			Blue/Bleu	Res/Rés	Tim/Tmp	Code
A-20	LANG Melody	1	2	LI Nashi	0 - 5	3:00	WAZ
A-29	LANG Melody	1	3	AU Megan	0 - 10	3:00	IPO
B-2	LI Nashi	2	3	AU Megan	10 - 0	3:00	IPO

Results/Résultats

Pos	Name/Nom
1	LI Nashi, Seiei Dojo
2	AU Megan, BC/Peak Judo Club

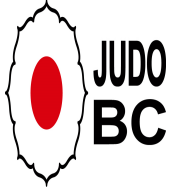

U14 Female -44kg



Competitors/Compétiteurs

#	Name/Nom	Grade	Club	1	2	1	2	1	2	W/G	Pts	Pos
1	KARAS Christina	green	AB/Kodokwai	XX	10	XX	10	XX		2	20	1
2	FOSTERSON Trinity	orange/green	BC/Nanaimo Judo Club		XX		XX		XX	0	0	2

Matches/Matches

Match	White/Blanc	1	2	Blue/Bleu	Res/Rés	Tim/Tmp	Code
B-23	KARAS Christina	1	2	FOSTERSON Trinity	10 - 0	1:01	WIP
B-33	FOSTERSON Trinity	2	1	KARAS Christina	0 - 10	0:57	IPO
B-41	KARAS Christina	1	2	FOSTERSON Trinity			

Results/Résultats

Pos	Name/Nom
1	KARAS Christina, AB/Kodokwai

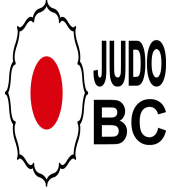

U14 Female -52kg



Competitors/Compétiteurs

#	Name/Nom	Grade	Club	1	2	3	W/G	Pts	Pos
1	MCCLEERY Saige	green/blue	Ippon Judo Dojo	XX	10	10	2	20	1
2	ORTIZ Manuela	green	QC/Métropolitain		XX	10	1	10	2
3	KEIRSTEAD Wish	green	BC/Shidokai			XX	0	0	3

Matches/Matches

Match	White/Blanc			Blue/Bleu	Res/Rés	Tim/Tmp	Code
A-23	MCCLEERY Saige	1	2	ORTIZ Manuela	10 - 0	3:44	GSI
A-34	MCCLEERY Saige	1	3	KEIRSTEAD Wish	10 - 0	0:38	IPO
B-3	ORTIZ Manuela	2	3	KEIRSTEAD Wish	10 - 0	1:25	IPO

Results/Résultats

Pos	Name/Nom
1	MCCLEERY Saige, Ippon Judo Dojo
2	ORTIZ Manuela, QC/Métropolitain

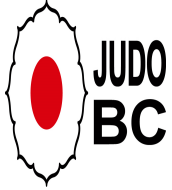

U14 Female -63kg



Competitors/Compétiteurs

#	Name/Nom	Grade	Club	1	2	1	2	1	2	W/G	Pts	Pos
1	DEBANKS Vanessa	green	BC/White Rock	XX	10	XX	5	XX		2	15	1
2	PUSHKIN Aurora	orange	BC/Steveston		XX		XX		XX	0	0	2

Matches/Matches

Match	White/Blanc			Blue/Bleu	Res/Rés	Tim/Tmp	Code
D-16	DEBANKS Vanessa	1	2	PUSHKIN Aurora	10 - 0	0:59	IPO
D-28	PUSHKIN Aurora	2	1	DEBANKS Vanessa	0 - 5	3:00	WAZ
D-46	DEBANKS Vanessa	1	2	PUSHKIN Aurora			

Results/Résultats

Pos	Name/Nom
1	DEBANKS Vanessa, BC/White Rock

U14 Female +63kg

Competitors/Compétiteurs

#	Name/Nom	Grade	Club	1	2	3	W/G	Pts	Pos
1	BONIFACIO Kaiya	blue	Budokan Dojo	XX	5	10	2	15	1
2	ALIYEVA Emiliya	green	AB/Hiro's		XX	10	1	10	2
3	MACDOUGALL Jaelyn	orange/green	BC/Abbotsford			XX	0	0	3

Matches/Matches

Match	White/Blanc			Blue/Bleu	Res/Rés	Tim/Tmp	Code
A-19	BONIFACIO Kaiya	1	2	ALIYEVA Emiliya	5 - 0	3:00	WAZ
A-28	BONIFACIO Kaiya	1	3	MACDOUGALL Jaelyn	10 - 0	1:13	IPO
B-1	ALIYEVA Emiliya	2	3	MACDOUGALL Jaelyn	10 - 0	0:15	IPO

Results/Résultats

Pos	Name/Nom
1	BONIFACIO Kaiya, Budokan Dojo
2	ALIYEVA Emiliya, AB/Hiro's

U14 Male -35kg

Competitors/Compétiteurs

#	Name/Nom	Grade	Club	1	2	3	W/G	Pts	Pos
1	LE BRIS Ewen	green	BC/Peak Judo Club	XX	10	10	2	20	1
2	TAMURA Grayson	green	AB/Lethbridge		XX		0	0	3
3	TEPLITSKIY Roman	orange	ON/Taifu		10	XX	1	10	2

Matches/Matches

Match	White/Blanc			Blue/Bleu	Res/Rés	Tim/Tmp	Code
C-18	LE BRIS Ewen	1	2	TAMURA Grayson	10 - 0	0:35	IPO
C-32	LE BRIS Ewen	1	3	TEPLITSKIY Roman	10 - 0	3:00	IPO
C-42	TAMURA Grayson	2	3	TEPLITSKIY Roman	0 - 10	1:08	WIP

Results/Résultats

Pos	Name/Nom
1	LE BRIS Ewen, BC/Peak Judo Club
2	TEPLITSKIY Roman, ON/Taifu

U14 Male -38kg

Competitors/Compétiteurs

#	Name/Nom	Grade	Club	1	2	3	4	5	W/G	Pts	Pos
1	SEMYROZUM Roman	green/blue	QC/Ippon	XX	10	10	5	10	4	35	1
2	PARKER Sebastian	orange	AB/Barracuda		XX				0	0	5
3	LÉONARD Félix	orange/green	SK/Moose Jaw		10	XX			1	10	4
4	LOLIEV Akhmed	green/blue	BC/Peak Judo Club		10	10	XX	10	3	30	2
5	WONG Lawren	green	BC/Nakashima		10	10		XX	2	20	3

Matches/Matches

Match	White/Blanc			Blue/Bleu	Res/Rés	Tim/Tmp	Code
B-7	LOLIEV Akhmed	4	5	WONG Lawren	10 - 0	2:27	WIP
B-8	SEMYROZUM Roman	1	2	PARKER Sebastian	10 - 0	0:12	IPO
B-13	LÉONARD Félix	3	4	LOLIEV Akhmed	0 - 10	1:45	WIP
B-14	SEMYROZUM Roman	1	5	WONG Lawren	10 - 0	0:24	IPO
B-19	PARKER Sebastian	2	3	LÉONARD Félix	0 - 10	0:00	FUS
B-20	SEMYROZUM Roman	1	4	LOLIEV Akhmed	5 - 0	3:00	WAZ
B-25	LÉONARD Félix	3	5	WONG Lawren	0 - 10	0:11	IPO
B-26	PARKER Sebastian	2	4	LOLIEV Akhmed	0 - 10	0:00	FUS
B-37	SEMYROZUM Roman	1	3	LÉONARD Félix	10 - 0	0:19	IPO
B-38	PARKER Sebastian	2	5	WONG Lawren	0 - 10	0:00	FUS

Results/Résultats

Pos	Name/Nom
1	SEMYROZUM Roman, QC/Ippon
2	LOLIEV Akhmed, BC/Peak Judo Club
3	WONG Lawren, BC/Nakashima
4	LÉONARD Félix, SK/Moose Jaw

U14 Male -42kg

Competitors/Compétiteurs

#	Name/Nom	Grade	Club	1	2	3	4	5	W/G	Pts	Pos
1	TAKEKAWA Masato	orange/green	BC/Nanaimo Judo Club	XX	10				1	10	5
2	AMAR Sahvan	green	BC/White Rock		XX			10	1	10	3
3	JOHNSON Kohen	green	AB/Tokugawa	10	10	XX	10	10	4	40	1
4	KO Logan	green	BC/Peak Judo Club	10	10		XX	5	3	25	2
5	NAZARI Artin	green	BC/Peak Judo Club	10				XX	1	10	4

Matches/Matches

Match	White/Blanc			Blue/Bleu	Res/Rés	Tim/Tmp	Code
C-10	KO Logan	4	5	NAZARI Artin	5 - 0	3:00	WAZ
C-11	TAKEKAWA Masato	1	2	AMAR Sahvan	10 - 0	3:00	GSI
C-16	JOHNSON Kohen	3	4	KO Logan	10 - 0	3:00	IPO
C-17	TAKEKAWA Masato	1	5	NAZARI Artin	0 - 10	3:00	WIP
C-21	AMAR Sahvan	2	3	JOHNSON Kohen	0 - 10	0:16	IPO
C-22	TAKEKAWA Masato	1	4	KO Logan	0 - 10	2:19	WIP
C-27	JOHNSON Kohen	3	5	NAZARI Artin	10 - 0	1:45	IPO
C-28	AMAR Sahvan	2	4	KO Logan	0 - 10	1:31	IPO
C-37	TAKEKAWA Masato	1	3	JOHNSON Kohen	0 - 10	2:04	WIP
C-38	AMAR Sahvan	2	5	NAZARI Artin	10 - 0	1:32	IPO

Results/Résultats

Pos	Name/Nom
1	JOHNSON Kohen, AB/Tokugawa
2	KO Logan, BC/Peak Judo Club
3	AMAR Sahvan, BC/White Rock
3	NAZARI Artin, BC/Peak Judo Club

U14 Male -46kg

Competitors/Compétiteurs

#	Name/Nom	Grade	Club	1	2	3	4	5	W/G	Pts	Pos
1	JOHNSON Rex	orange	BC/Abbotsford	XX			10		1	10	4
2	KLYMENKO Max	orange	BC/Police Jr.	10	XX		10		2	20	3
3	MAEDA Tai	blue	Seiei Dojo	10	10	XX	10		3	30	2
4	PARK Kingston	orange	BC/Peak Judo Club				XX		0	0	5
5	TEMIRBAEV Amir	green/blue	BC/Peak Judo Club	10	10	10	10	XX	4	40	1

Matches/Matches

Match	White/Blanc		Blue/Bleu	Res/Rés	Tim/Tmp	Code
D-1	PARK Kingston	4	5	TEMIRBAEV Amir	0 - 10	0:53 IPO
D-2	JOHNSON Rex	1	2	KLYMENKO Max	0 - 10	0:25 IPO
D-6	MAEDA Tai	3	4	PARK Kingston	10 - 0	0:55 IPO
D-7	JOHNSON Rex	1	5	TEMIRBAEV Amir	0 - 10	0:20 IPO
D-11	KLYMENKO Max	2	3	MAEDA Tai	0 - 10	0:39 IPO
D-12	JOHNSON Rex	1	4	PARK Kingston	10 - 0	1:46 IPO
D-23	MAEDA Tai	3	5	TEMIRBAEV Amir	0 - 10	2:22 IPO
D-24	KLYMENKO Max	2	4	PARK Kingston	10 - 0	1:53 WIP
D-35	JOHNSON Rex	1	3	MAEDA Tai	0 - 10	1:06 IPO
D-36	KLYMENKO Max	2	5	TEMIRBAEV Amir	0 - 10	1:06 IPO

Results/Résultats

Pos	Name/Nom
1	TEMIRBAEV Amir, BC/Peak Judo Club
2	MAEDA Tai, Seiei Dojo
3	KLYMENKO Max, BC/Police Jr.
4	JOHNSON Rex, BC/Abbotsford

Competitors/Compétiteurs A

#	Name/Nom	Grade	Club	1	2	3	W/G	Pts	Pos
1	ITO Taiyo	orange/green	BC/Steveston	XX	10		1	10	2
2	ARUTYUNYAN Eric	green	BC/Steveston		XX		0	0	3
3	KIM Aiden	orange	BC/Champion	10	10	XX	2	20	1

Pool A

Match	White/Blanc	Blue/Bleu	Res/Rés	Tim/Tmp	Code
B-17	ITO Taiyo 1 2	ARUTYUNYAN Eric	10 - 0	3:00	IPO
B-27	ITO Taiyo 1 3	KIM Aiden	0 - 10	0:25	IPO
B-35	ARUTYUNYAN Eric 2 3	KIM Aiden	0 - 10	0:51	IPO

Competitors/Compétiteurs B

#	Name/Nom	Grade	Club	4	5	6	W/G	Pts	Pos
4	SHEVCHENKO Yegor	blue	BC/Champion	XX	10	10	2	20	1
5	COLNEY John	green/blue	AB/Kodokwai		XX		0	0	3
6	CLARK James	green	BC/Steveston		10	XX	1	10	2

Pool B

Match	White/Blanc	Blue/Bleu	Res/Rés	Tim/Tmp	Code
B-18	SHEVCHENKO Yegor 4 5	COLNEY John	10 - 0	3:00	IPO
B-28	SHEVCHENKO Yegor 4 6	CLARK James	10 - 0	0:32	IPO
B-36	COLNEY John 5 6	CLARK James	0 - 10	0:11	IPO

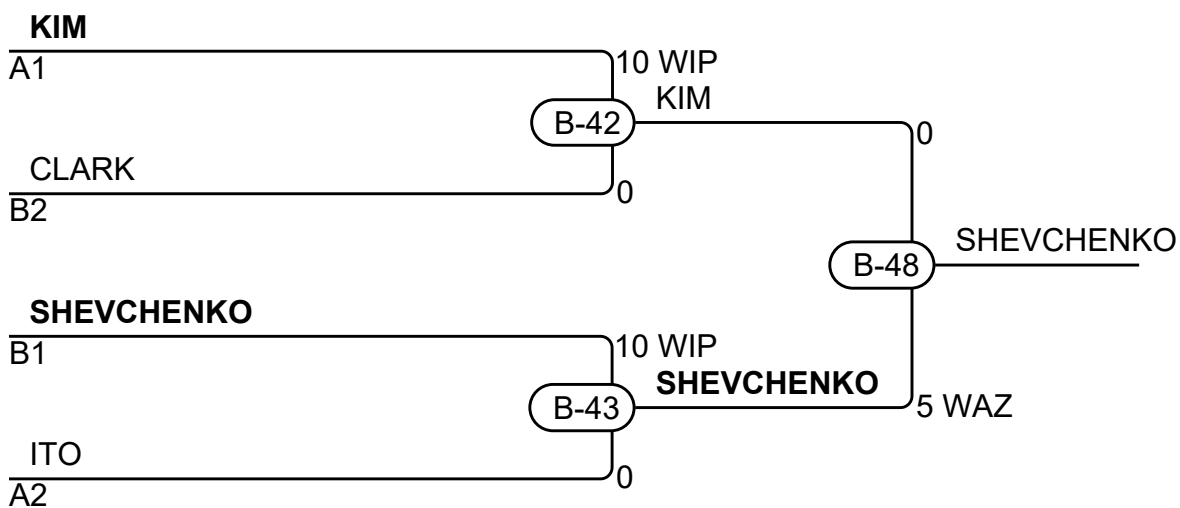

Results/Résultats

Pos	Name/Nom
1	SHEVCHENKO Yegor, BC/Champion
2	KIM Aiden, BC/Champion
3	CLARK James, BC/Steveston
3	ITO Taiyo, BC/Steveston

U14 Male -55kg

Competitors/Compétiteurs

#	Name/Nom	Grade	Club	1	2	3	4	W/G	Pts	Pos
1	ROTBART Orion	orange/green	BC/Abbotsford	XX	10	10		2	20	2
2	LUDLOW Elijah	orange	BC/Shidokai		XX	5		1	5	3
3	TOLCHAMOV Tymur	orange	AB/Airdrie			XX		0	0	4
4	SOKOLOV Emelyan	green	ON/Taifu	10	10	10	XX	3	30	1

Matches/Matches

Match	White/Blanc			Blue/Bleu	Res/Rés	Tim/Tmp	Code
C-19	ROTBART Orion	1	2	LUDLOW Elijah	10 - 0	1:19	IPO
C-20	TOLCHAMOV Tymur	3	4	SOKOLOV Emelyan	0 - 10	0:29	WIP
C-33	ROTBART Orion	1	3	TOLCHAMOV Tymur	10 - 0	0:39	WIP
C-34	LUDLOW Elijah	2	4	SOKOLOV Emelyan	0 - 10	0:12	IPO
C-43	ROTBART Orion	1	4	SOKOLOV Emelyan	0 - 10	0:55	IPO
C-44	LUDLOW Elijah	2	3	TOLCHAMOV Tymur	5 - 0	3:00	WAZ

Results/Résultats

Pos	Name/Nom
1	SOKOLOV Emelyan, ON/Taifu
2	ROTBART Orion, BC/Abbotsford
3	LUDLOW Elijah, BC/Shidokai

U14 Male -66kg

Competitors/Compétiteurs

#	Name/Nom	Grade	Club	1	2	3	4	W/G	Pts	Pos
1	ZAHEDI Datis Cy	orange	BC/Champion	XX	10		10	2	20	2
2	KIM Cason	orange	BC/Ishikawa Family		XX			0	0	4
3	GREGORY Drake	green	AB/Lethbridge	10	10	XX	10	3	30	1
4	OUDOVIKINE Daniel	green	ON/Taifu		10		XX	1	10	3

Matches/Matches

Match	White/Blanc			Blue/Bleu	Res/Rés	Tim/Tmp	Code
C-12	ZAHEDI Datis Cy	1	2	KIM Cason	10 - 0	3:00	IPO
C-15	GREGORY Drake	3	4	OUDOVIKINE Daniel	10 - 0	0:50	IPO
C-30	ZAHEDI Datis Cy	1	3	GREGORY Drake	0 - 10	0:38	WIP
C-31	KIM Cason	2	4	OUDOVIKINE Daniel	0 - 10	0:00	IPO
C-40	ZAHEDI Datis Cy	1	4	OUDOVIKINE Daniel	10 - 0	1:55	HAN
C-41	KIM Cason	2	3	GREGORY Drake	0 - 10	0:38	IPO

Results/Résultats

Pos	Name/Nom
1	GREGORY Drake, AB/Lethbridge
2	ZAHEDI Datis Cy, BC/Champion
3	OUDOVIKINE Daniel, ON/Taifu

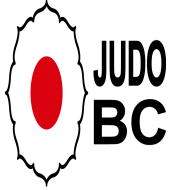

U14 Male +66kg



Competitors/Compétiteurs

#	Name/Nom	Grade	Club	1	2	1	2	1	2	W/G	Pts	Pos
1	EMMANUELE Francesco	orange	BC/Port Coquitlam	XX		XX		XX		0	0	2
2	ROBERTSON Mitchell	green	BC/Lake Country	10	XX	5	XX		XX	2	15	1

Matches/Matches

Match	White/Blanc			Blue/Bleu	Res/Rés	Tim/Tmp	Code
D-15	EMMANUELE Francesco	1	2	ROBERTSON Mitchell	0 - 10	2:31	HAN
D-27	ROBERTSON Mitchell	2	1	EMMANUELE Francesco	5 - 0	3:00	WAZ
D-39	EMMANUELE Francesco	1	2	ROBERTSON Mitchell			

Results/Résultats

Pos	Name/Nom
1	ROBERTSON Mitchell, BC/Lake Country

U18 Female -48kg

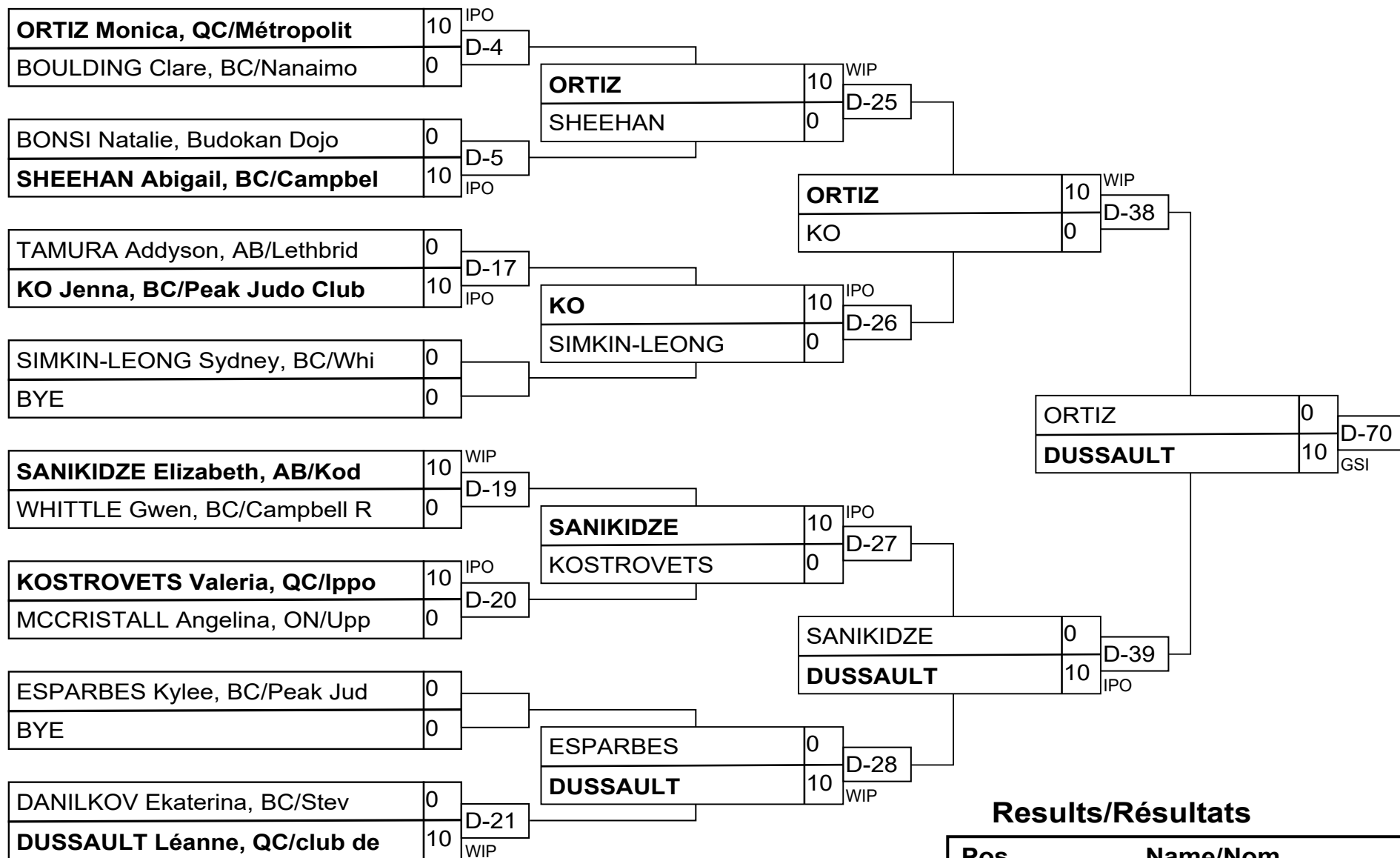

Results/Résultats

Pos	Name/Nom
1	DUSSAULT Léanne, QC/club
2	ORTIZ Monica, QC/Métropo
3	KO Jenna, BC/Peak Judo C
3	WHITTLE Gwen, BC/Campbel

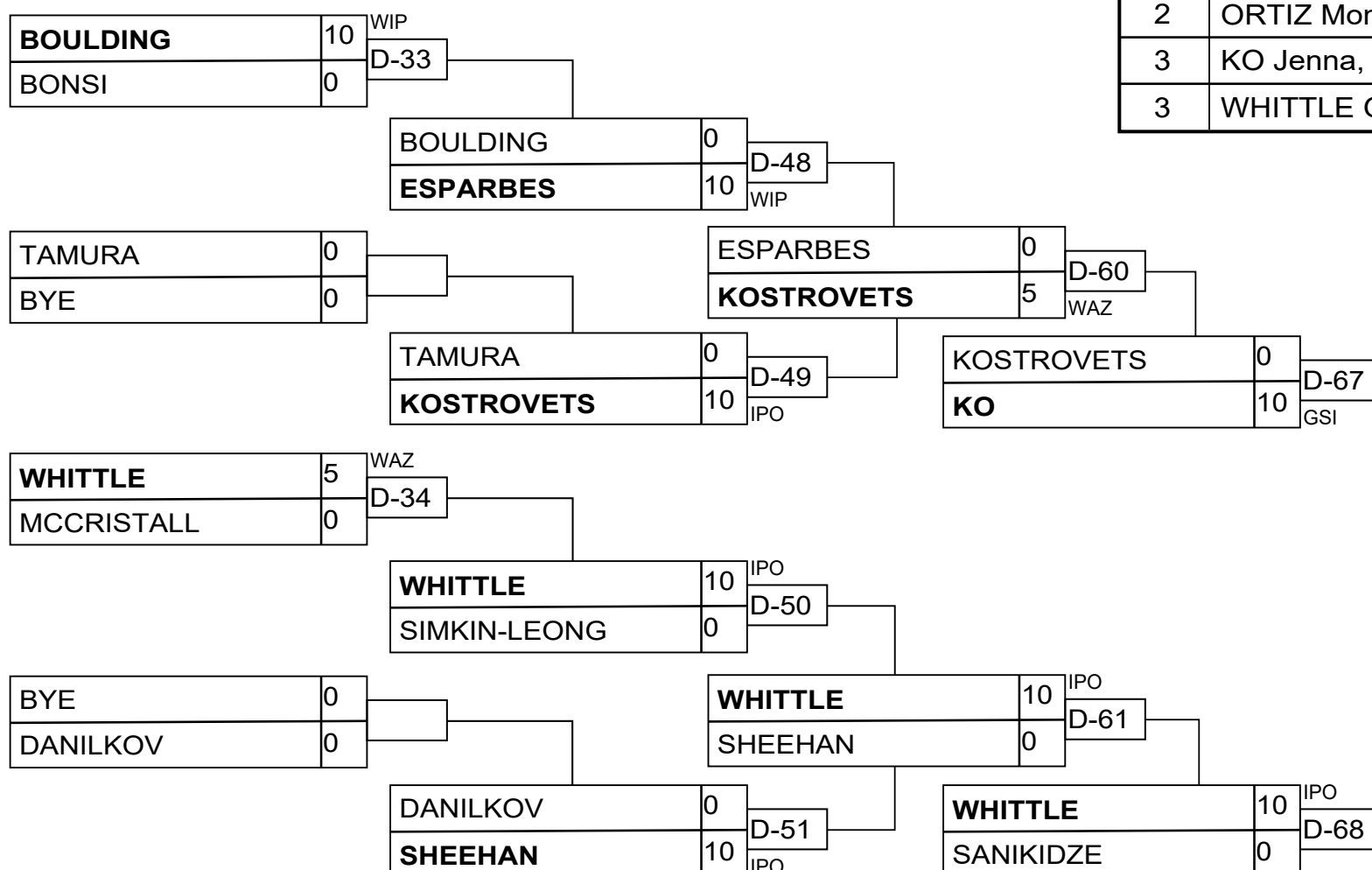

U18 Female -52kg

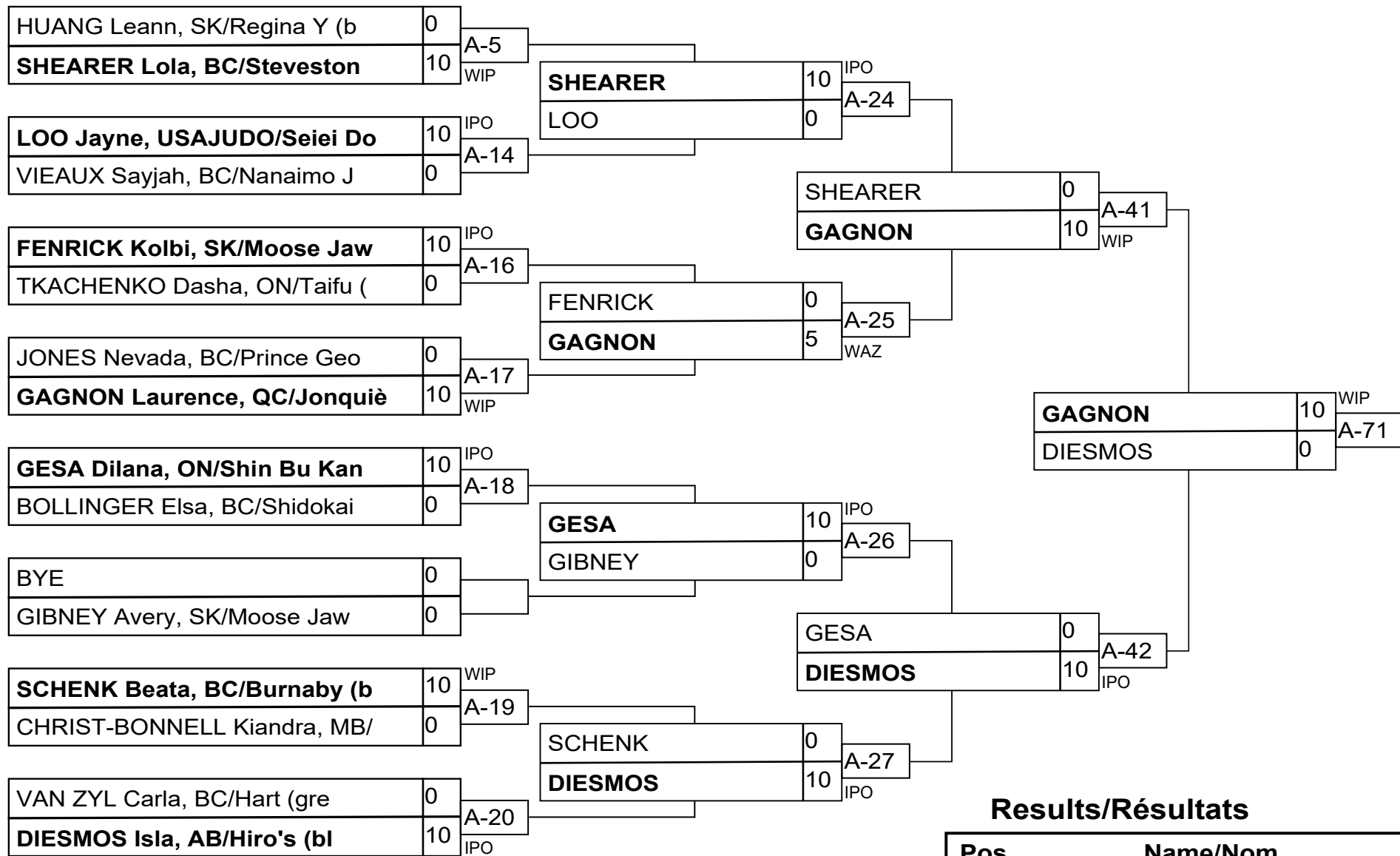

Results/Résultats

Pos	Name/Nom
1	GAGNON Laurence, QC/Jonq
2	DIOSMOS Isla, AB/Hiro's
3	HUANG Leann, SK/Regina Y
3	GESA Dilana, ON/Shin Bu

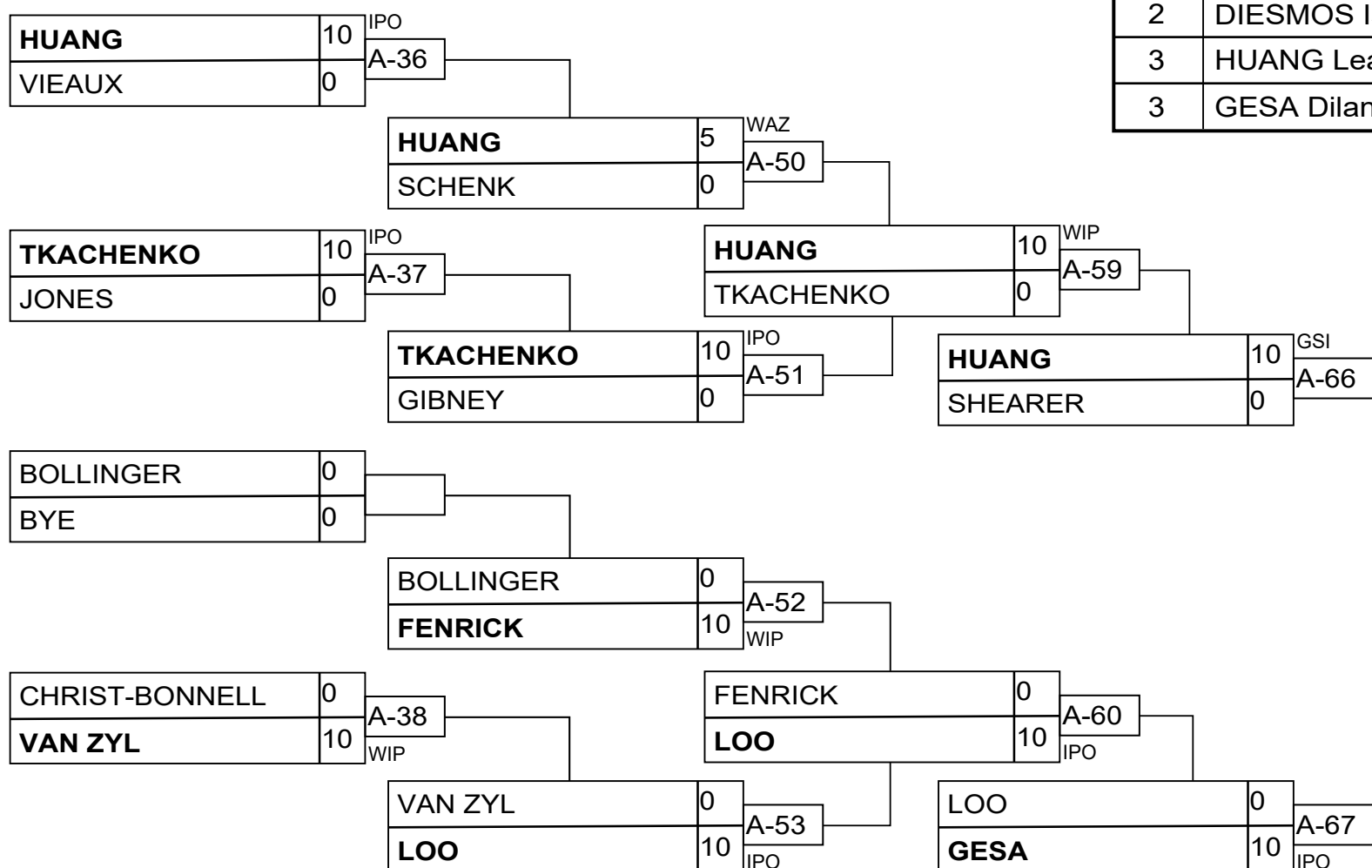

U18 Female -57kg

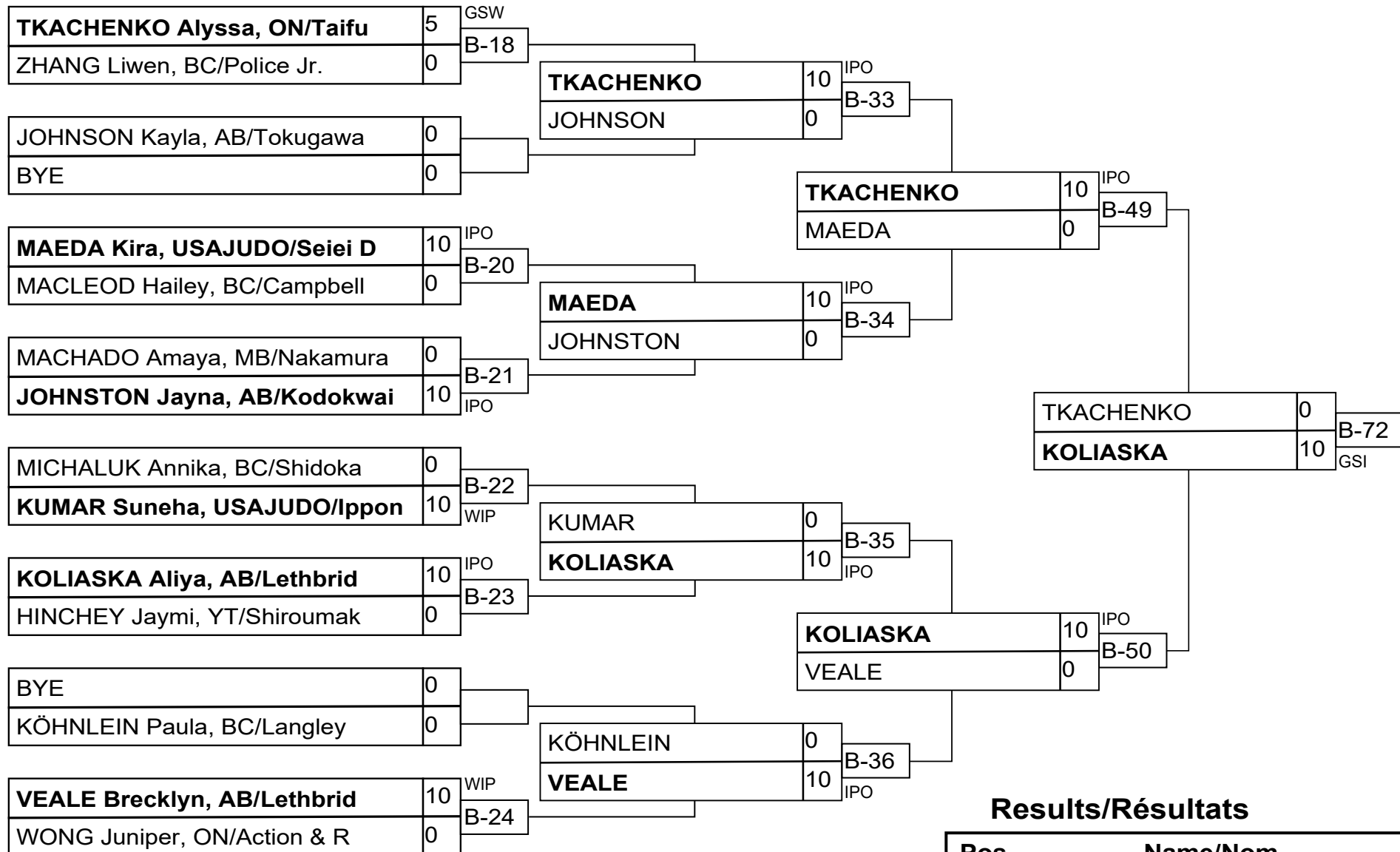

Results/Résultats

Pos	Name/Nom
1	KOLIASKA Aliya, AB/Lethb
2	TKACHENKO Alyssa, ON/Tai
3	MAEDA Kira, USAJUDO/Seie
3	VEALE Brecklyn, AB/Lethb

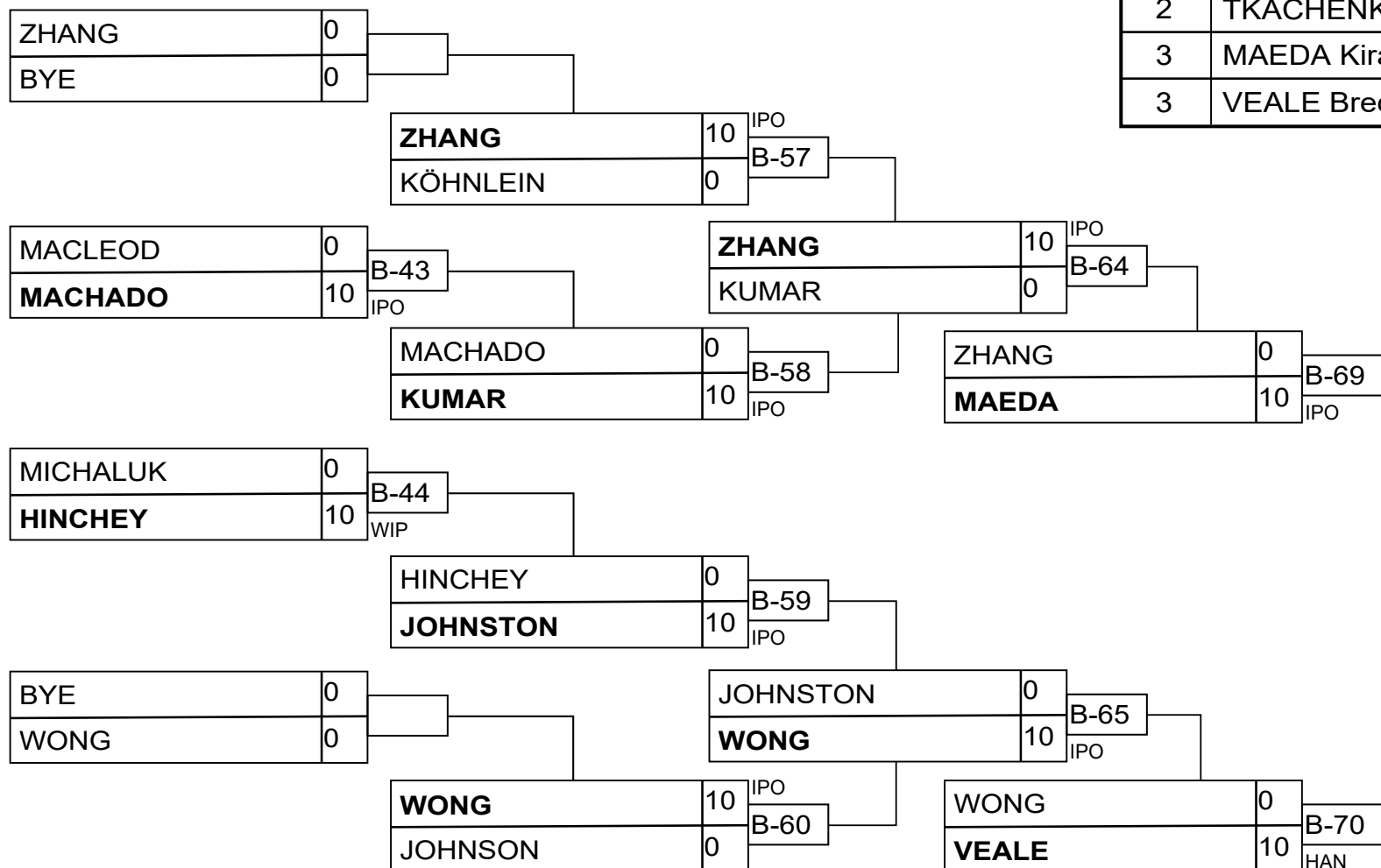

U18 Female -63kg

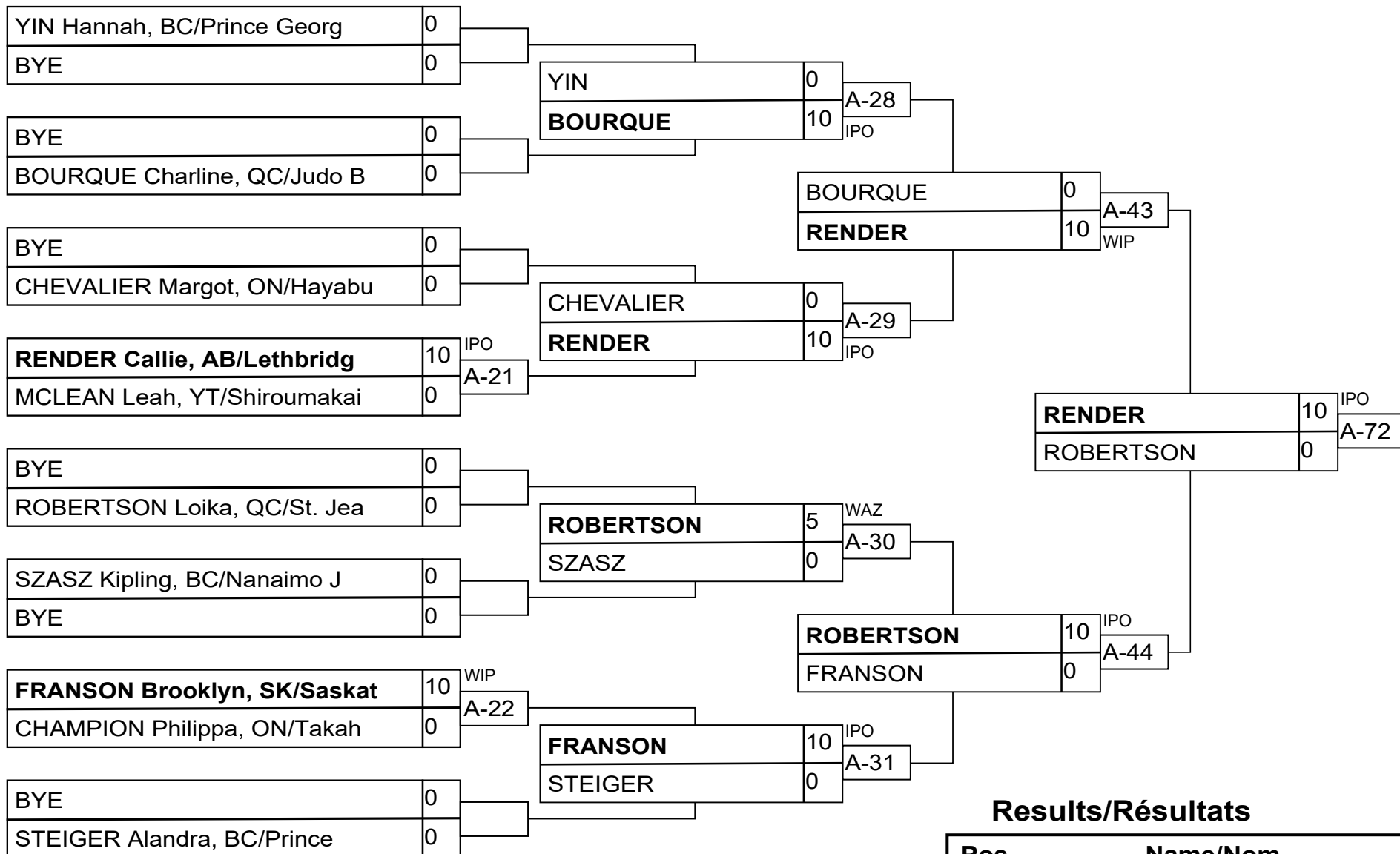

Results/Résultats

Pos	Name/Nom
1	RENDER Callie, AB/Lethbr
2	ROBERTSON Loika, QC/St.
3	BOURQUE Charline, QC/Jud
3	CHEVALIER Margot, ON/Hay

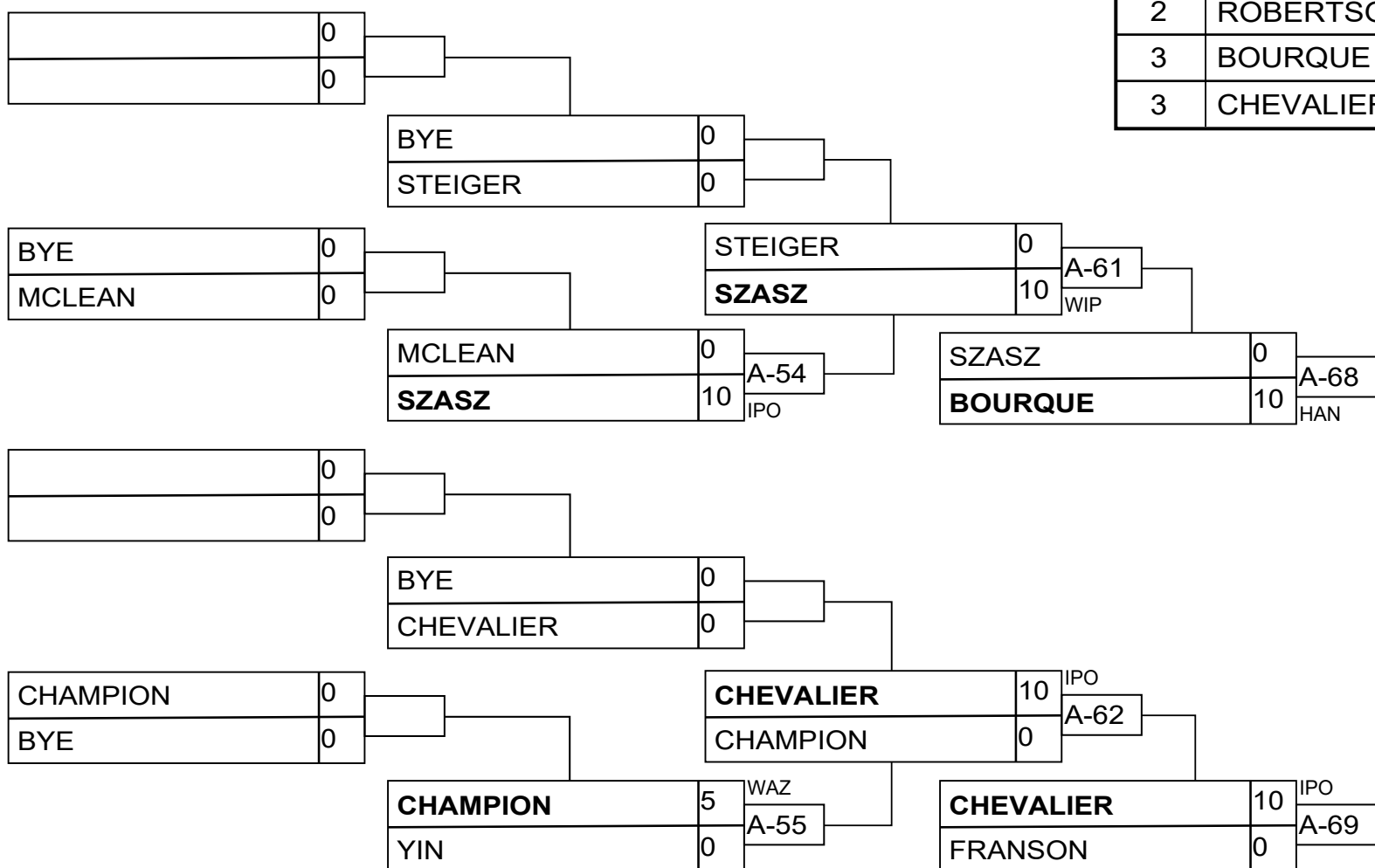

U18 Female -70kg

Competitors/Compétiteurs

#	Name/Nom	Grade	Club	1	2	3	4	W/G	Pts	Pos
1	GILL Loane	brown	QC/Métropolitain	XX			10	1	10	3
2	MORISHO Nyota	shodan	BC/Kokushikai	10	XX		10	2	20	2
3	BURT Kiera	brown	ON/Upper Canada	10	10	XX	10	3	30	1
4	GALLANT Madison	blue	AB/Lethbridge				XX	0	0	4

Matches/Matches

Match	White/Blanc			Blue/Bleu	Res/Rés	Tim/Tmp	Code
C-50	GILL Loane	1	2	MORISHO Nyota	0 - 10	1:51	WIP
C-51	BURT Kiera	3	4	GALLANT Madison	10 - 0	0:28	IPO
C-59	GILL Loane	1	3	BURT Kiera	0 - 10	2:31	IPO
C-60	MORISHO Nyota	2	4	GALLANT Madison	10 - 0	0:22	IPO
C-65	GILL Loane	1	4	GALLANT Madison	10 - 0	0:36	IPO
C-66	MORISHO Nyota	2	3	BURT Kiera	0 - 10	0:49	IPO

Results/Résultats

Pos	Name/Nom
1	BURT Kiera, ON/Upper Canada
2	MORISHO Nyota, BC/Kokushikai
3	GILL Loane, QC/Métropolitain

U18 Male -46kg

Competitors/Compétiteurs

#	Name/Nom	Grade	Club	1	2	3	W/G	Pts	Pos
1	MOES Ezekiel	green/blue	BC/Nanaimo Judo Club	XX			0	0	3
2	WEBBER Justin	blue	AB/Hiro's	10	XX		1	10	2
3	PAMPOLINA Avery	green	MB/Nakamura	10	10	XX	2	20	1

Matches/Matches

Match	White/Blanc			Blue/Bleu	Res/Rés	Tim/Tmp	Code
A-45	MOES Ezekiel	1	2	WEBBER Justin	0 - 10	1:26	WIP
A-56	MOES Ezekiel	1	3	PAMPOLINA Avery	0 - 10	1:51	WIP
A-63	WEBBER Justin	2	3	PAMPOLINA Avery	0 - 10	1:46	WIP

Results/Résultats

Pos	Name/Nom
1	PAMPOLINA Avery, MB/Nakamura
2	WEBBER Justin, AB/Hiro's

Competitors/Compétiteurs A

#	Name/Nom	Grade	Club	1	2	3	4	W/G	Pts	Pos
1	LANG Damian	green	USAJUDO/Seiei Dojo	XX	5	10	10	3	25	1
2	THIEL Nathan	brown	BC/Abbotsford		XX	10	10	2	20	2
3	MEJERY Andrey	green/blue	ON/Taifu			XX	10	1	10	3
4	METRIK Dar	green	MB/Nakamura				XX	0	0	4

Pool A

Match	White/Blanc			Blue/Bleu	Res/Rés	Tim/Tmp	Code
D-64A	LANG Damian	1	2	THIEL Nathan	5 - 0	5:51	GSW
D-41	MEJERY Andrey	3	4	METRIK Dar	10 - 0	0:28	IPO
D-52	LANG Damian	1	3	MEJERY Andrey	10 - 0	3:50	WIP
D-53	THIEL Nathan	2	4	METRIK Dar	10 - 0	1:22	IPO
D-62	LANG Damian	1	4	METRIK Dar	10 - 0	0:36	IPO
D-58	THIEL Nathan	2	3	MEJERY Andrey	10 - 0	0:50	IPO

Competitors/Compétiteurs B

#	Name/Nom	Grade	Club	5	6	7	W/G	Pts	Pos
5	CARTWRIGHT Levi	blue	BC/Prince George	XX			0	0	3
6	LOO Derek	blue	USAJUDO/Seiei Judo	10	XX	10	2	20	1
7	HAZELL Connor	blue	AB/Lethbridge	10		XX	1	10	2

Pool B

Match	White/Blanc			Blue/Bleu	Res/Rés	Tim/Tmp	Code
D-42	CARTWRIGHT Levi	5	6	LOO Derek	0 - 10	0:23	IPO
D-54	CARTWRIGHT Levi	5	7	HAZELL Connor	0 - 10	5:40	GSI
D-59	LOO Derek	6	7	HAZELL Connor	10 - 0	0:52	IPO

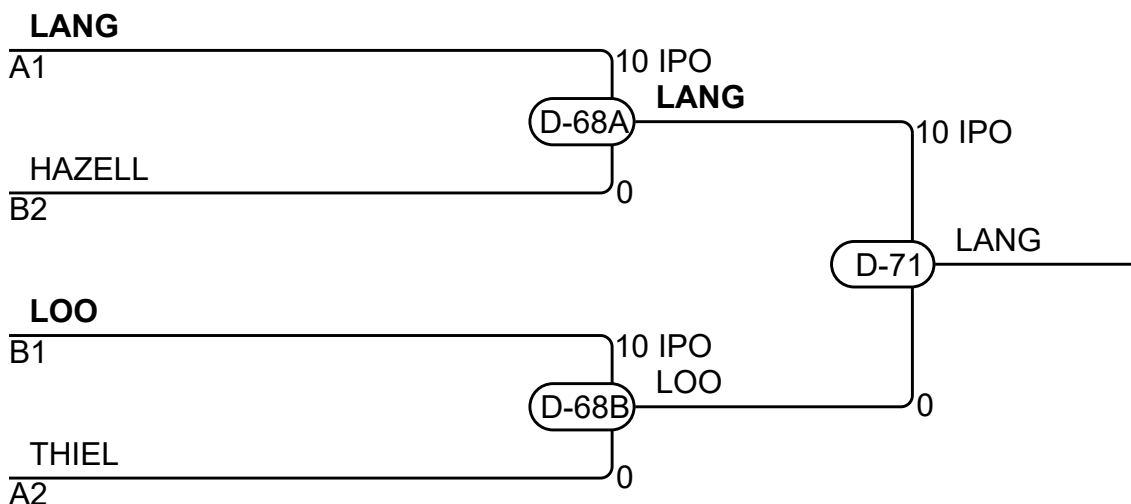

Results/Résultats

Pos	Name/Nom
1	LANG Damian, USAJUDO/Seiei Dojo
2	LOO Derek, USAJUDO/Seiei Judo
3	HAZELL Connor, AB/Lethbridge
3	THIEL Nathan, BC/Abbotsford

U18 Male -55kg

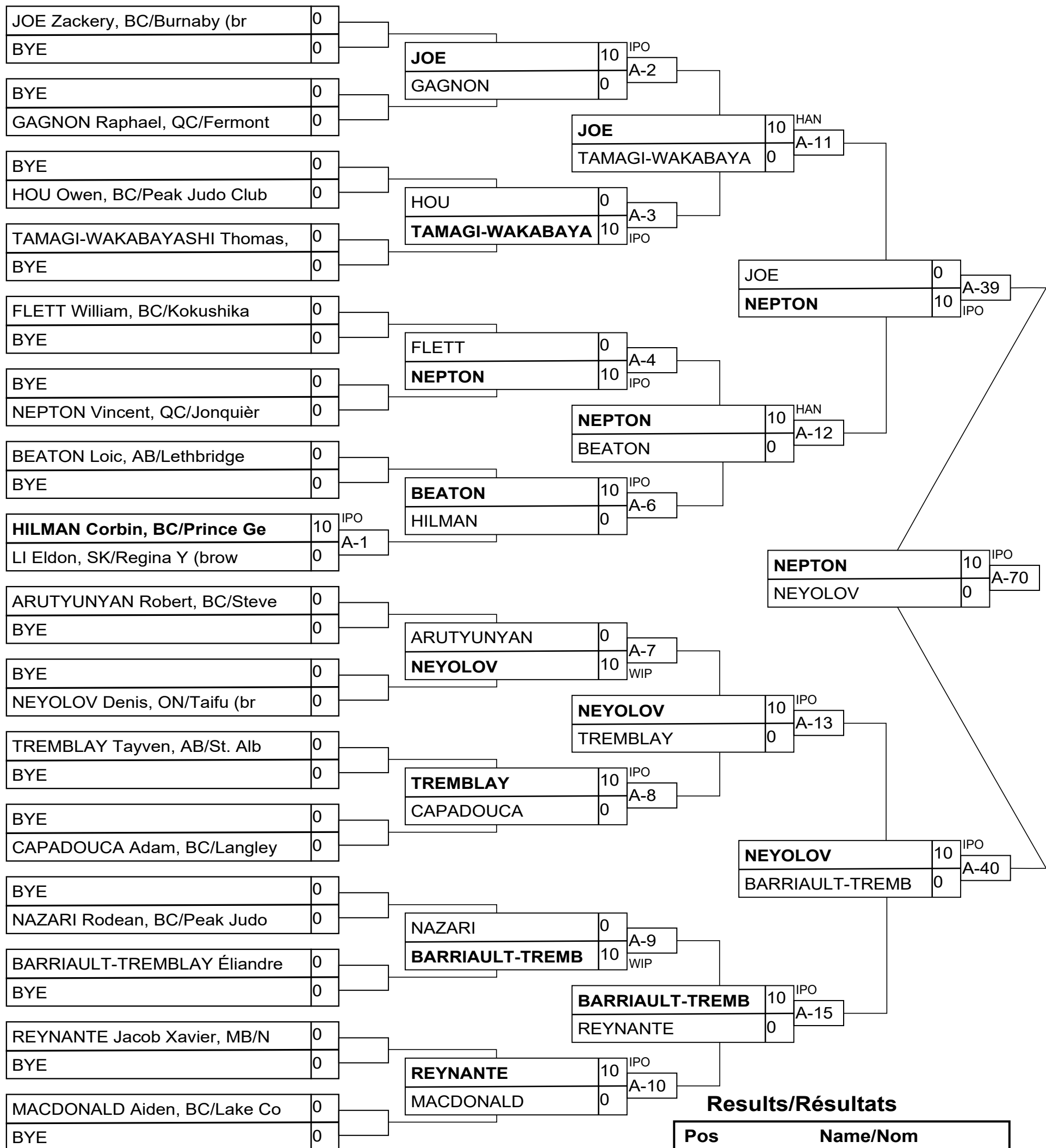

Results/Résultats

Pos	Name/Nom
1	NEPTON Vincent, QC/Jonqu
2	NEYOLOV Denis, ON/Taifu
3	TREMBLAY Tayven, AB/St.
3	BEATON Loic, AB/Lethbrid

U18 Male -55kg

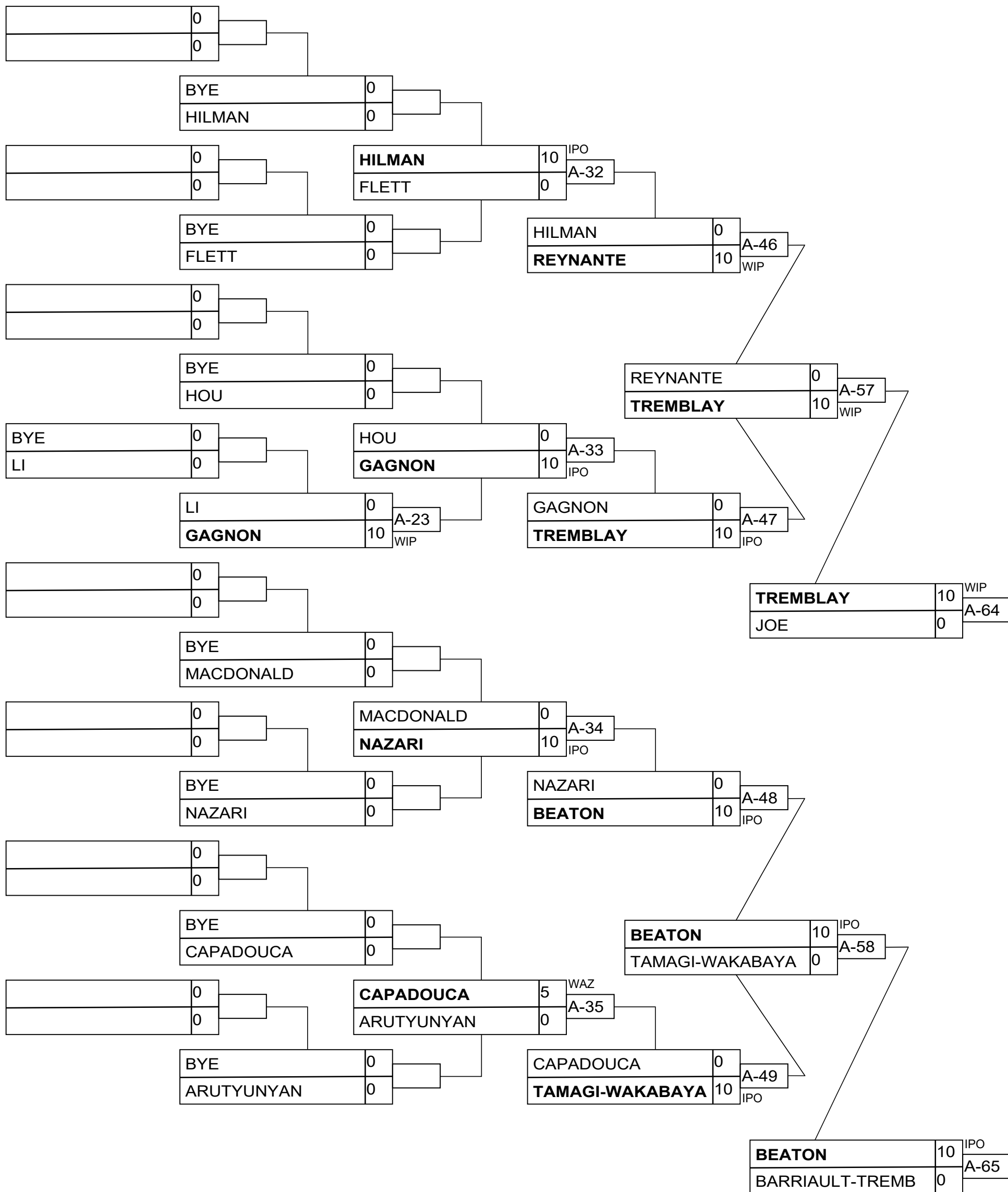

U18 Male -60kg

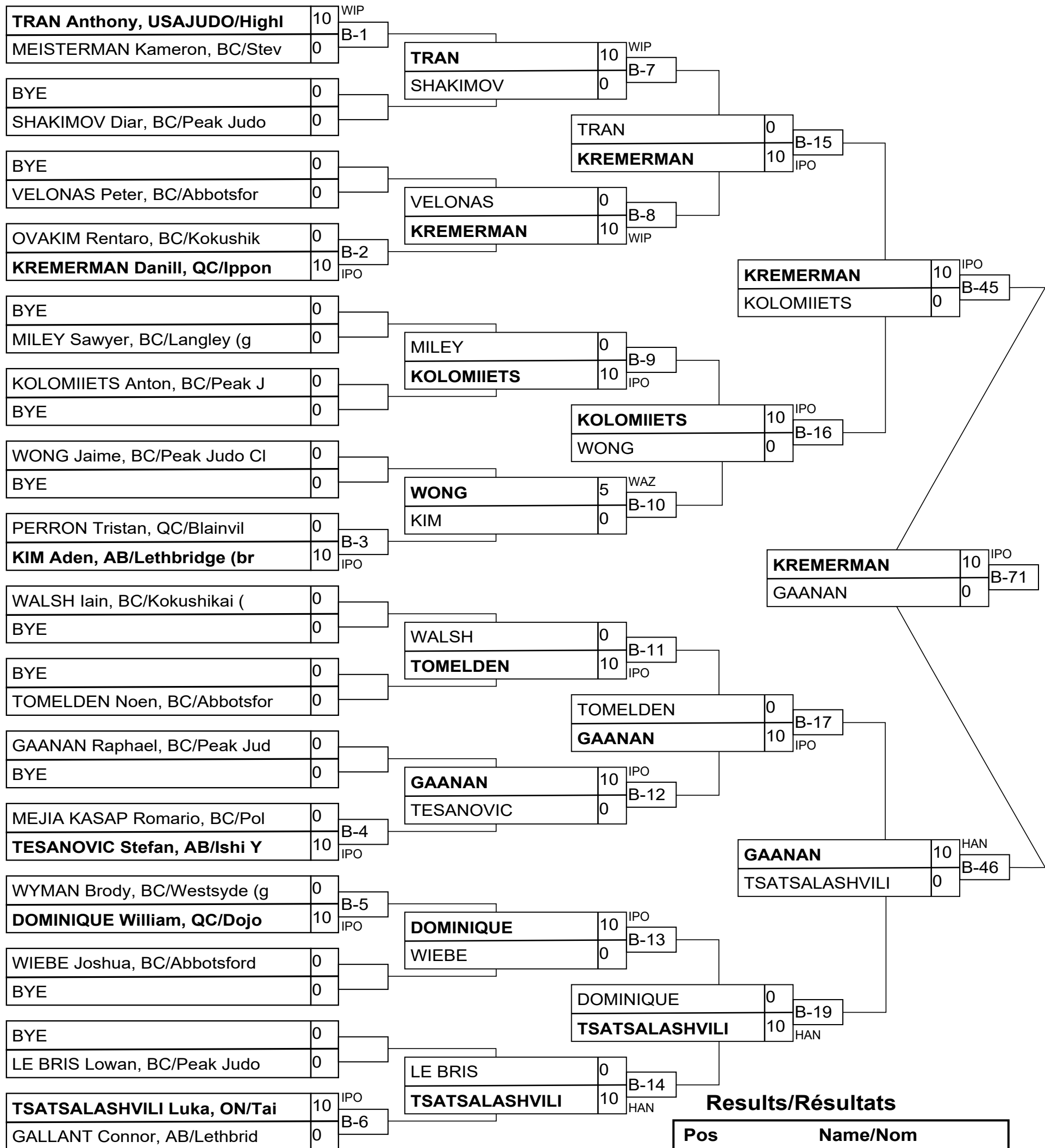

Results/Résultats

Pos	Name/Nom
1	KREMERMAN Danill, QC/Ipp
2	GAANAN Raphael, BC/Peak
3	DOMINIQUE William, QC/Do
3	TSATSALASHVILI Luka, ON/

U18 Male -60kg

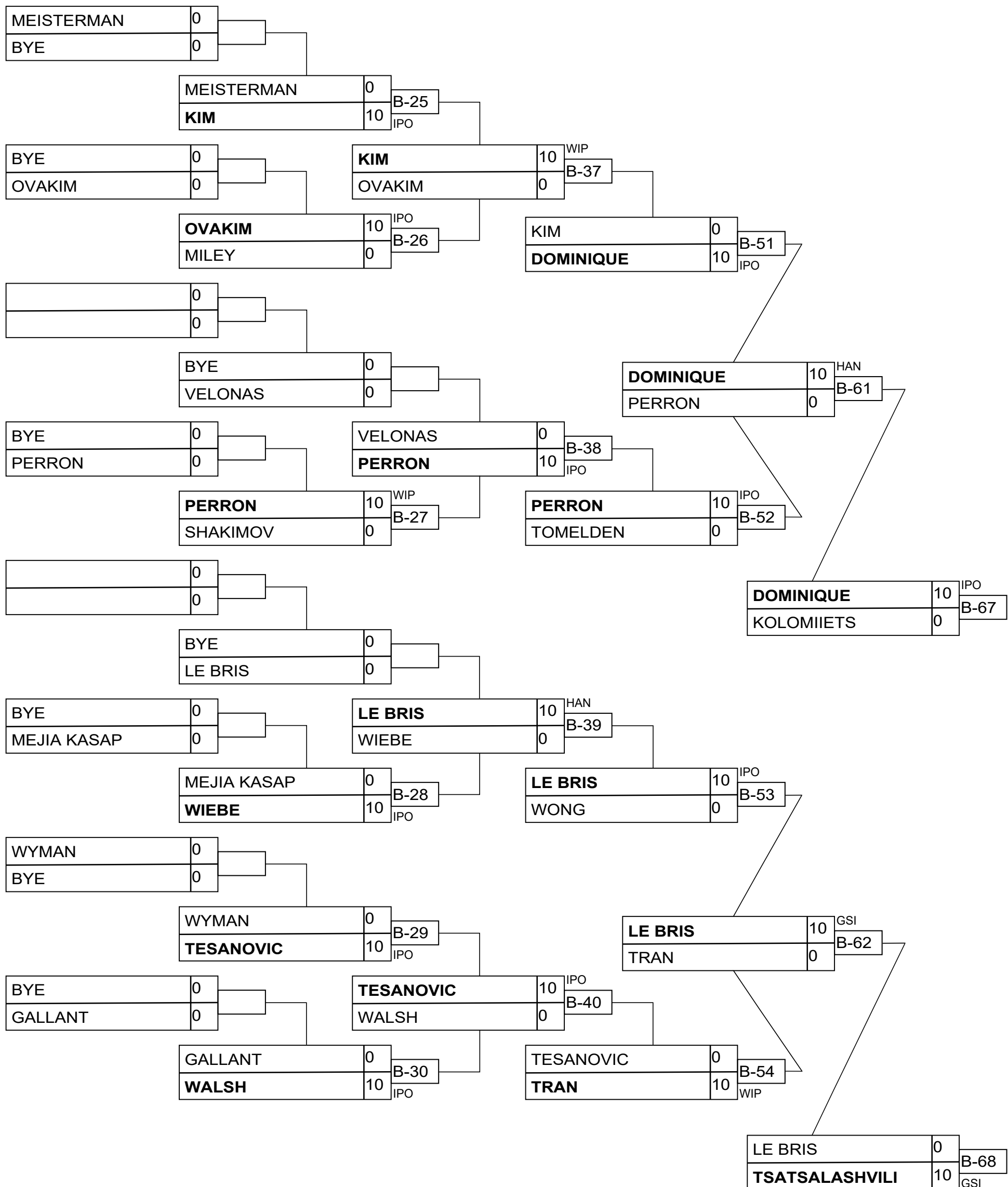

U18 Male -66kg

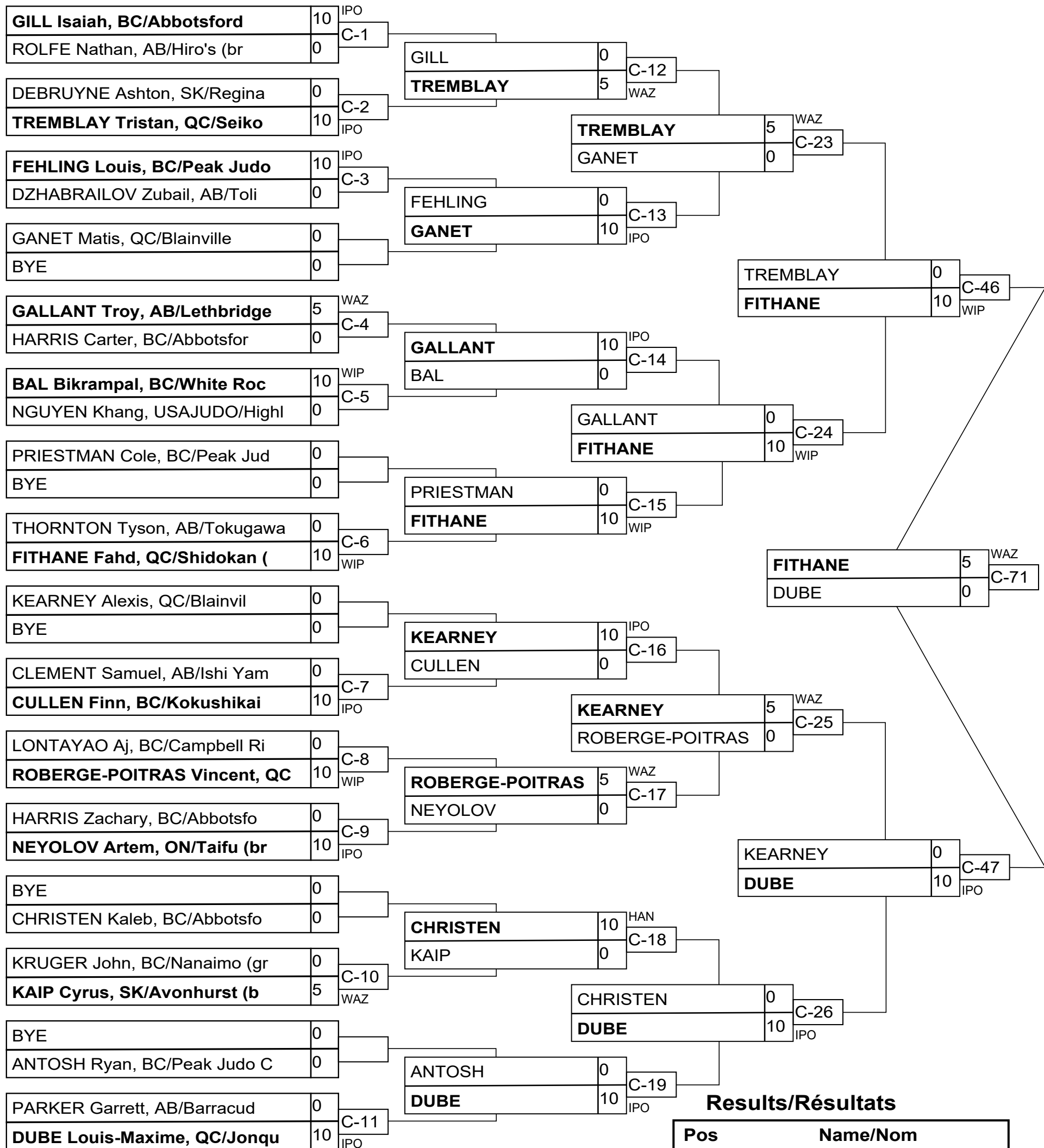

Results/Résultats

Pos	Name/Nom
1	FITHANE Fahd, QC/Shidoka
2	DUBE Louis-Maxime, QC/Jo
3	ROBERGE-POITRAS Vincent,
3	GANET Matis, QC/Blainvil

U18 Male -66kg

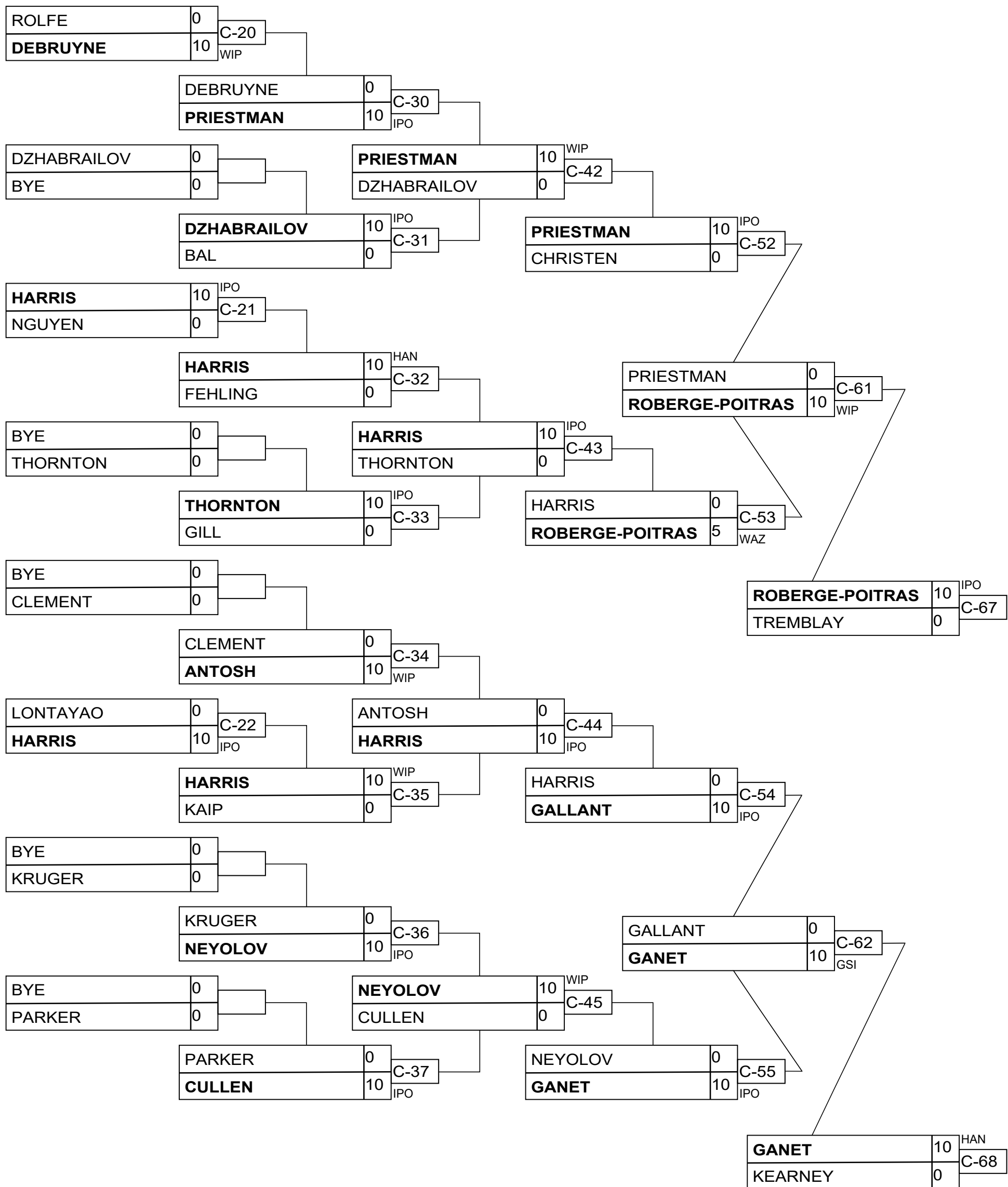

U18 Male -73kg

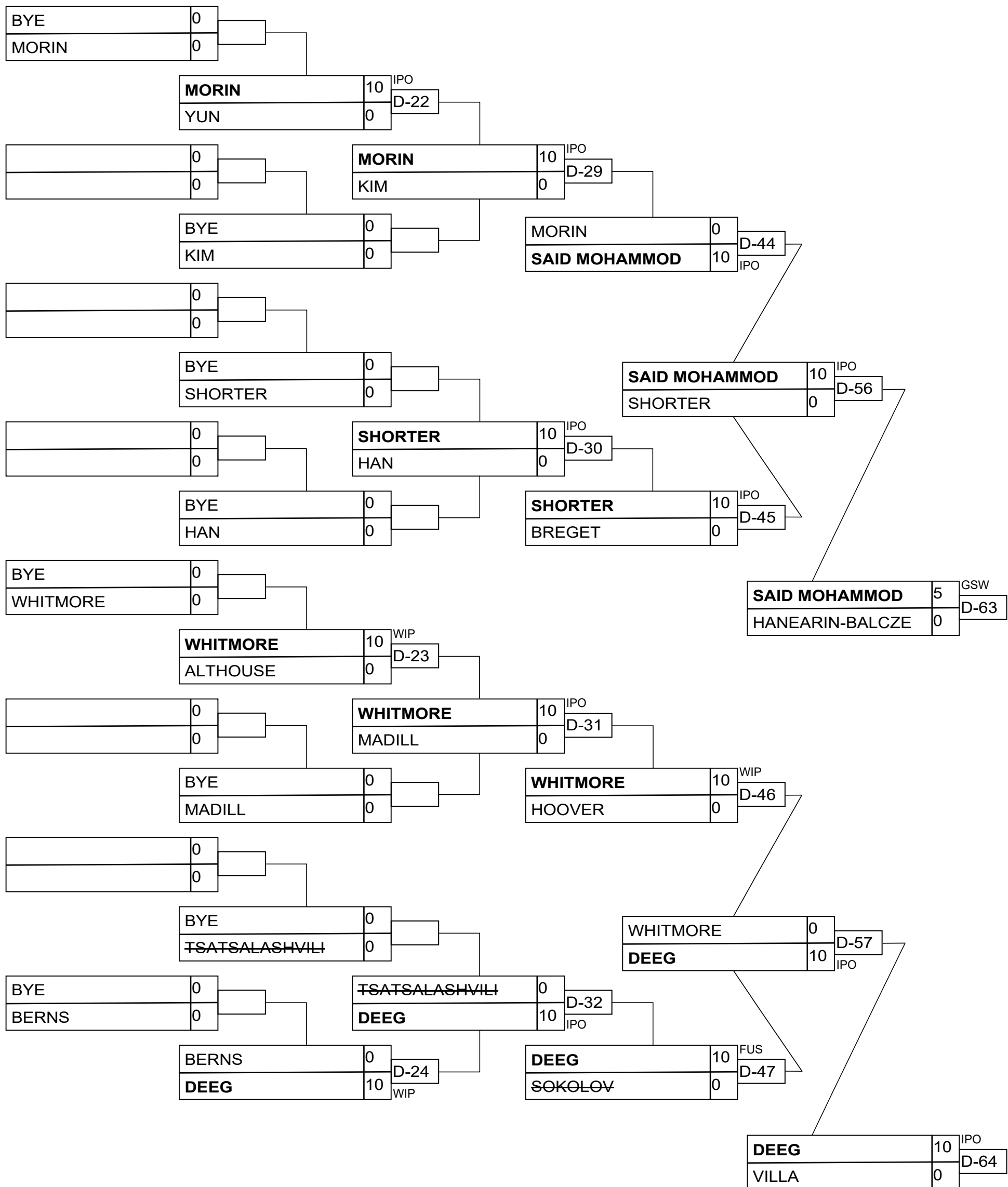

U18 Male -81kg

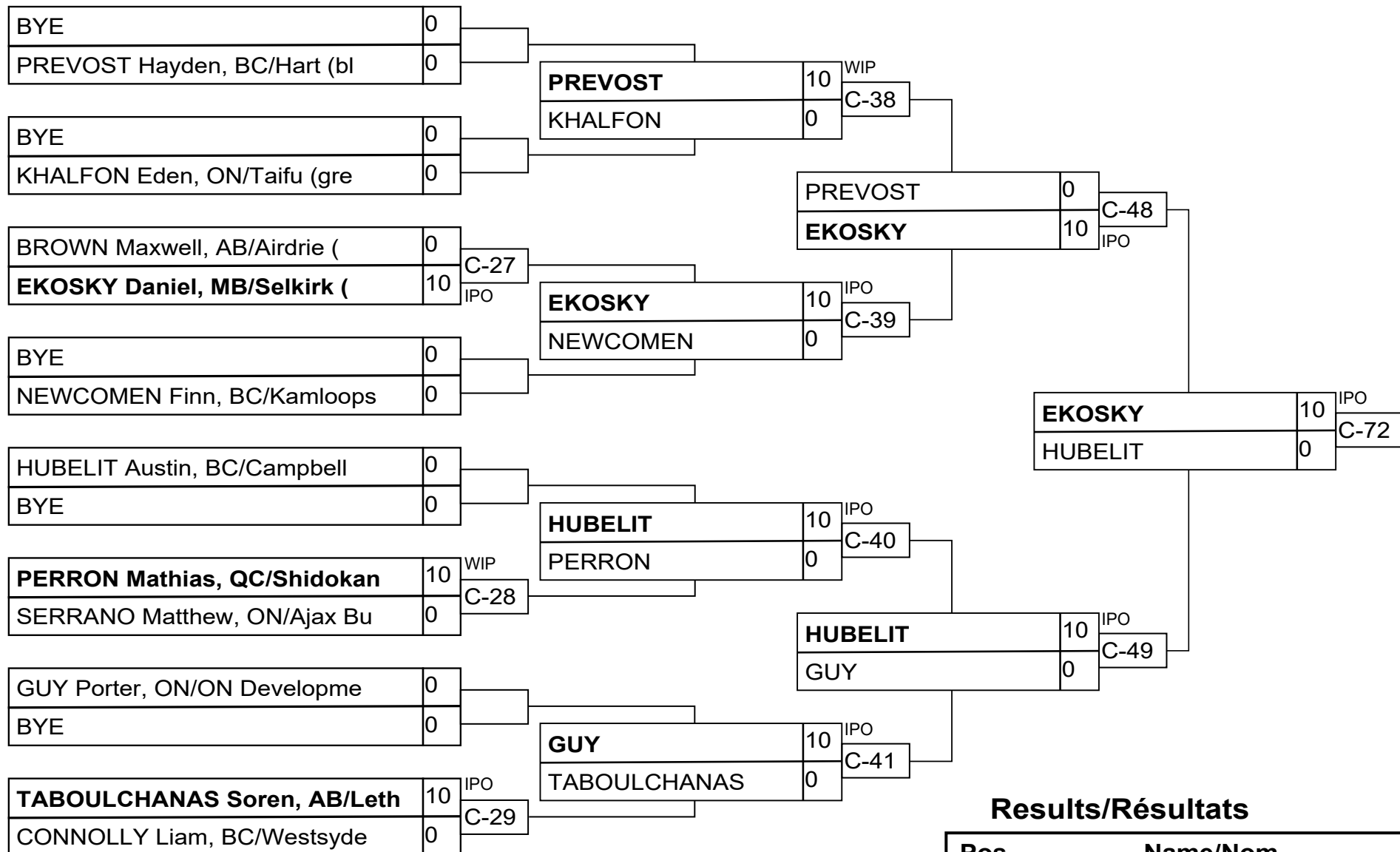

Results/Résultats

Pos	Name/Nom
1	EKOSKY Daniel, MB/Selkir
2	HUBELIT Austin, BC/Campb
3	PREVOST Hayden, BC/Hart
3	SERRANO Matthew, ON/Ajax

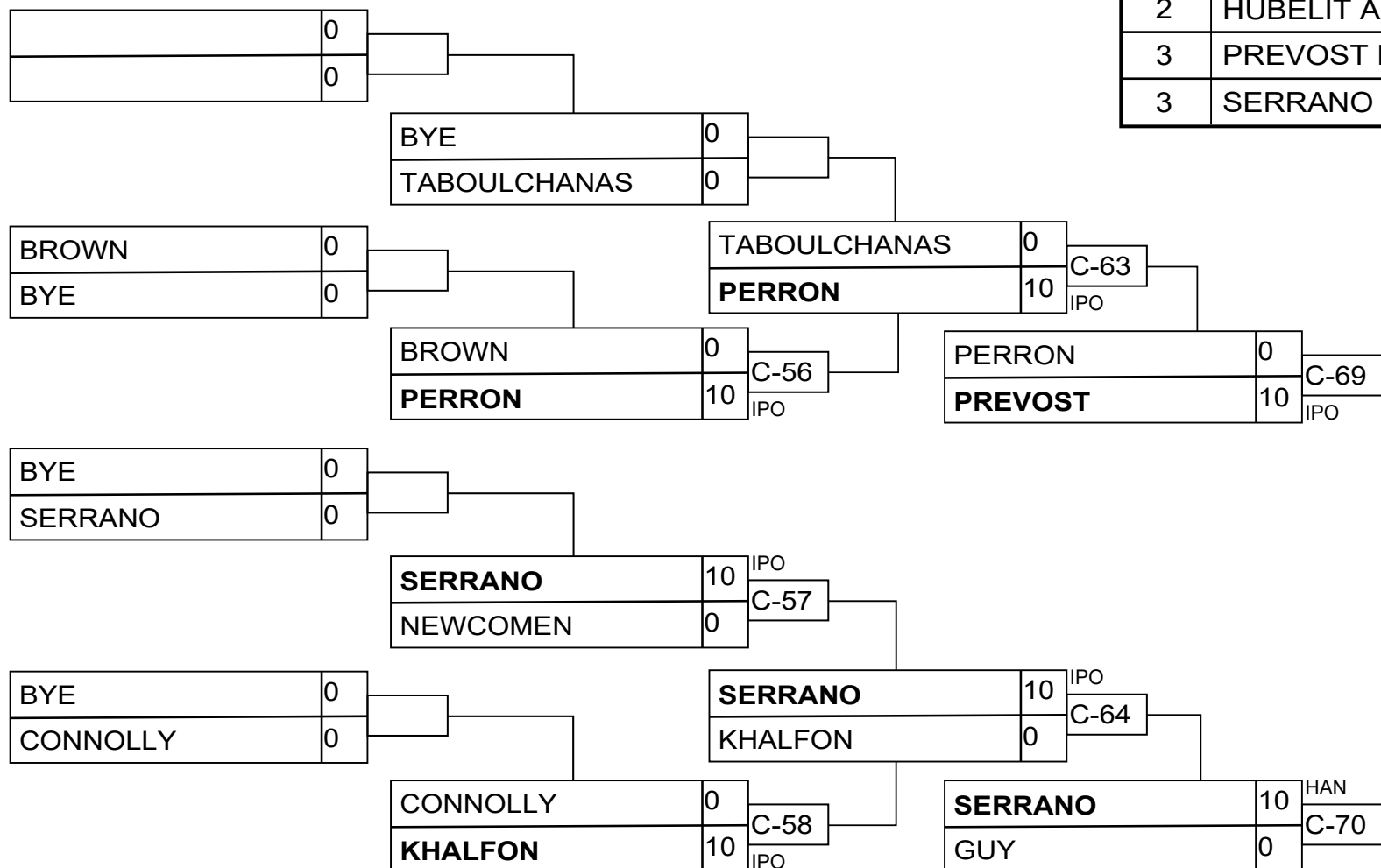

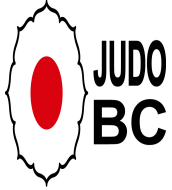

U18 Male -90kg



Competitors/Compétiteurs

#	Name/Nom	Grade	Club	1	2	3	W/G	Pts	Pos
1	ALIYEV Elmar	brown	AB/Hiro's	XX	10		1	10	2
2	FORSBERG Mattias	blue	AB/Lethbridge		XX		0	0	3
3	OGDEN Soren	brown	USAJUDO/Oak Tree Dojo	10	10	XX	2	20	1

Matches/Matches

Match	White/Blanc			Blue/Bleu	Res/Rés	Tim/Tmp	Code
D-35	ALIYEV Elmar	1	2	FORSBERG Mattias	10 - 0	0:28	IPO
D-43	ALIYEV Elmar	1	3	OGDEN Soren	0 - 10	0:32	IPO
D-55	FORSBERG Mattias	2	3	OGDEN Soren	0 - 10	0:05	IPO

Results/Résultats

Pos	Name/Nom
1	OGDEN Soren, USAJUDO/Oak Tree Dojo
2	ALIYEV Elmar, AB/Hiro's

U18 Male +90kg

Competitors/Compétiteurs

#	Name/Nom	Grade	Club	1	2	3	4	5	W/G	Pts	Pos
1	TAYLOR Corban	green	SK/Judo SK	XX		10	10	10	3	30	2
2	HALLETT Josiah	blue	SK/Regina Y	10	XX	10	10	10	4	40	1
3	POWER William	brown	QC/Fermont			XX	10	10	2	20	3
4	TAMAYOSE Ryu	blue/brown	BC/Steveston				XX	10	1	10	4
5	FERSHAU Asher	blue	BC/Abbotsford					XX	0	0	5

Matches/Matches

Match	White/Blanc			Blue/Bleu	Res/Rés	Tim/Tmp	Code
B-31	TAMAYOSE Ryu	4	5	FERSHAU Asher	10 - 0	0:38	WIP
B-32	TAYLOR Corban	1	2	HALLETT Josiah	0 - 10	0:46	IPO
B-41	POWER William	3	4	TAMAYOSE Ryu	10 - 0	3:08	HAN
B-42	TAYLOR Corban	1	5	FERSHAU Asher	10 - 0	0:12	IPO
B-47	HALLETT Josiah	2	3	POWER William	10 - 0	1:21	WIP
B-48	TAYLOR Corban	1	4	TAMAYOSE Ryu	10 - 0	0:15	IPO
B-55	POWER William	3	5	FERSHAU Asher	10 - 0	0:37	WIP
B-56	HALLETT Josiah	2	4	TAMAYOSE Ryu	10 - 0	1:13	IPO
B-63	TAYLOR Corban	1	3	POWER William	10 - 0	1:13	IPO
B-66	HALLETT Josiah	2	5	FERSHAU Asher	10 - 0	1:21	IPO

Results/Résultats

Pos	Name/Nom
1	HALLETT Josiah, SK/Regina Y
2	TAYLOR Corban, SK/Judo SK
3	POWER William, QC/Fermont
4	TAMAYOSE Ryu, BC/Steveston

U21 Female -48kg

Competitors/Compétiteurs

#	Name/Nom	Grade	Club	1	2	1	2	1	2	W/G	Pts	Pos
1	TURMEL Marie-Lune	brown	QC/Blainville	XX		XX		XX		0	0	2
2	QUACH Heidi	brown	QC/Métropolitain	10	XX	10	XX		XX	2	20	1

Matches/Matches

Match	White/Blanc			Blue/Bleu	Res/Rés	Tim/Tmp	Code
B-24	TURMEL Marie-Lune	1	2	QUACH Heidi	0 - 10	0:16	IPO
B-34	QUACH Heidi	2	1	TURMEL Marie-Lune	10 - 0	4:00	WIP
B-44	TURMEL Marie-Lune	1	2	QUACH Heidi			

Results/Résultats

Pos	Name/Nom
1	QUACH Heidi, QC/Métropolitain

U21 Female -52kg

Competitors/Compétiteurs A

#	Name/Nom	Grade	Club	1	2	3	W/G	Pts	Pos
1	SIMARD-LEJEUNE Mathilde	brown	C355 Tritton Judo	XX			0	0	3
2	GRENIER Amélie	shodan	QC/Ju Shin Kan	10	XX	10	2	20	1
3	OJAS Rayna	brown	UW Judo	10		XX	1	10	2

Pool A

Match	White/Blanc	Blue/Bleu	Res/Rés	Tim/Tmp	Code
D-13	SIMARD-LEJEUNE Mathilde 1 2	GRENIER Amélie	0 - 10	1:04	IPO
D-25	SIMARD-LEJEUNE Mathilde 1 3	OJAS Rayna	0 - 10	3:38	IPO
D-37	GRENIER Amélie 2 3	OJAS Rayna	10 - 0	1:58	WIP

Competitors/Compétiteurs B

#	Name/Nom	Grade	Club	4	5	6	W/G	Pts	Pos
4	LOUET Violette	brown	QC/Judo Monde	XX			0	0	3
5	BEATON Evelyn	shodan	AB/Lethbridge	10	XX	10	2	20	1
6	LOLIEVA Rakiia	shodan	BC/Peak Judo Club	10		XX	1	10	2

Pool B

Match	White/Blanc	Blue/Bleu	Res/Rés	Tim/Tmp	Code
D-14	LOUET Violette 4 5	BEATON Evelyn	0 - 10	1:40	IPO
D-26	LOUET Violette 4 6	LOLIEVA Rakiia	0 - 10	1:30	WIP
D-38	BEATON Evelyn 5 6	LOLIEVA Rakiia	10 - 0	2:10	WIP

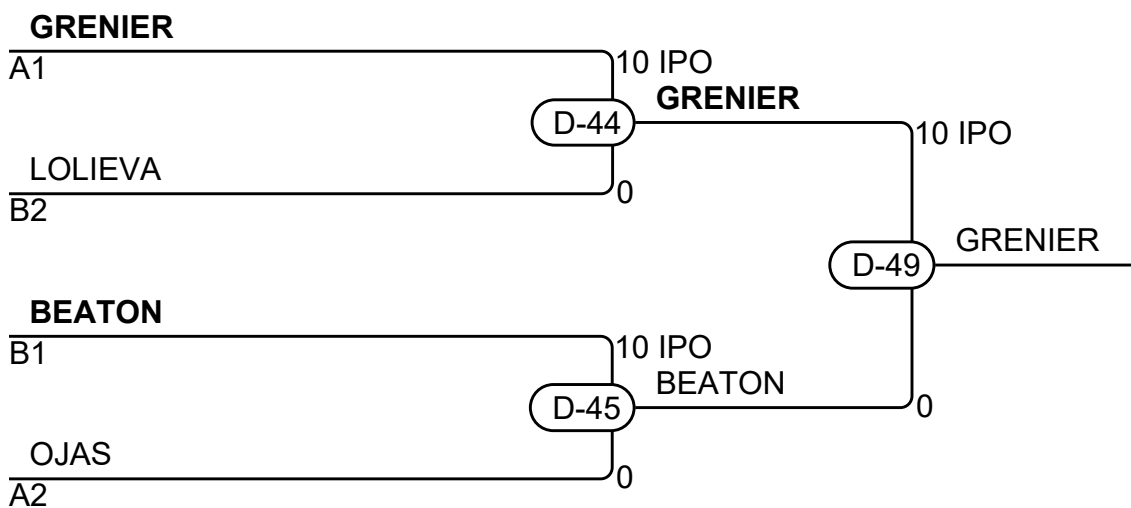

Results/Résultats

Pos	Name/Nom
1	GRENIER Amélie, QC/Ju Shin Kan
2	BEATON Evelyn, AB/Lethbridge
3	LOLIEVA Rakiia, BC/Peak Judo Club
3	OJAS Rayna, UW Judo

U21 Female -57kg

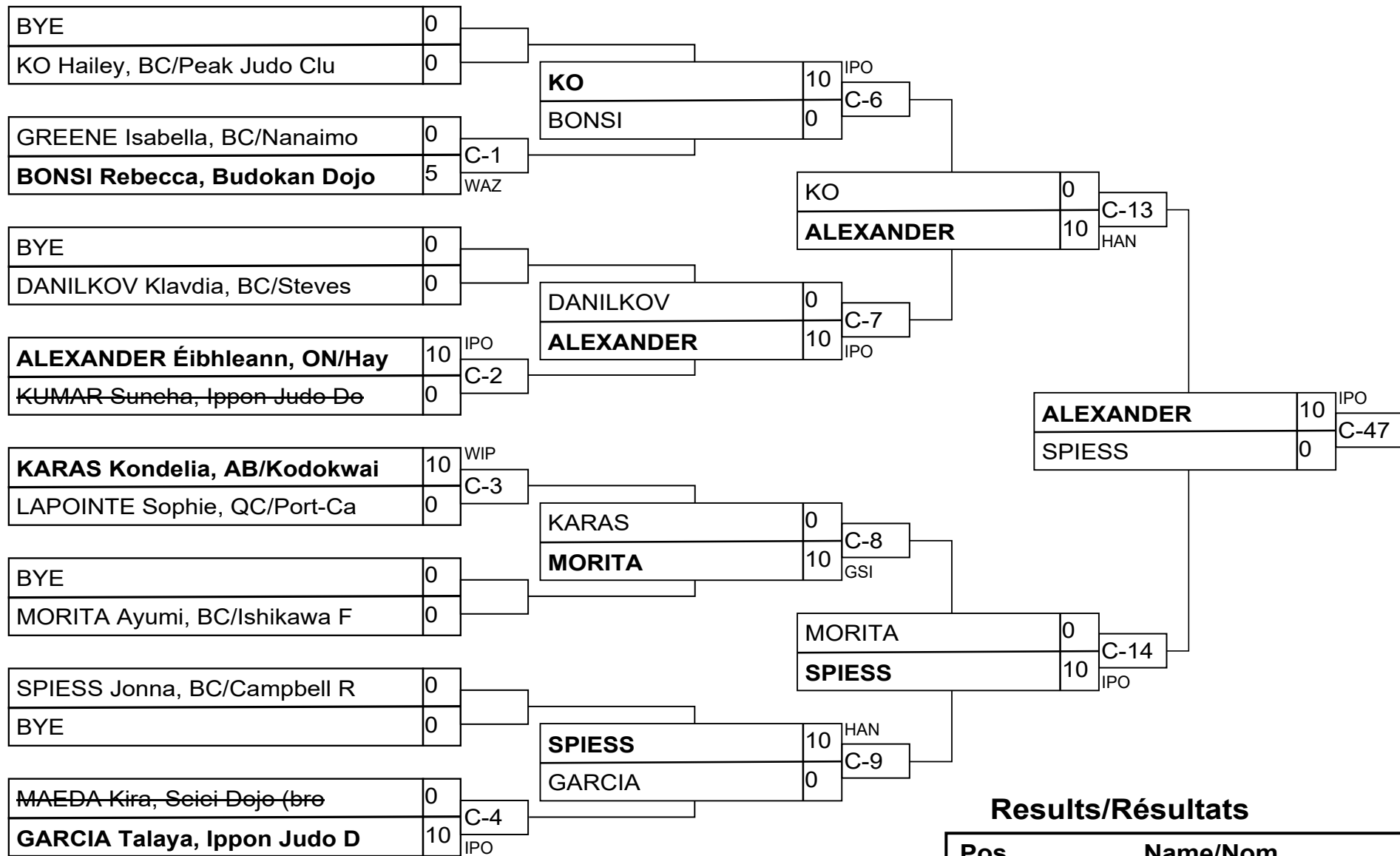

Results/Résultats

Pos	Name/Nom
1	ALEXANDER Éibhleann, ON/
2	SPIESS Jonna, BC/Campbel
3	KO Hailey, BC/Peak Judo
3	MORITA Ayumi, BC/Ishikaw

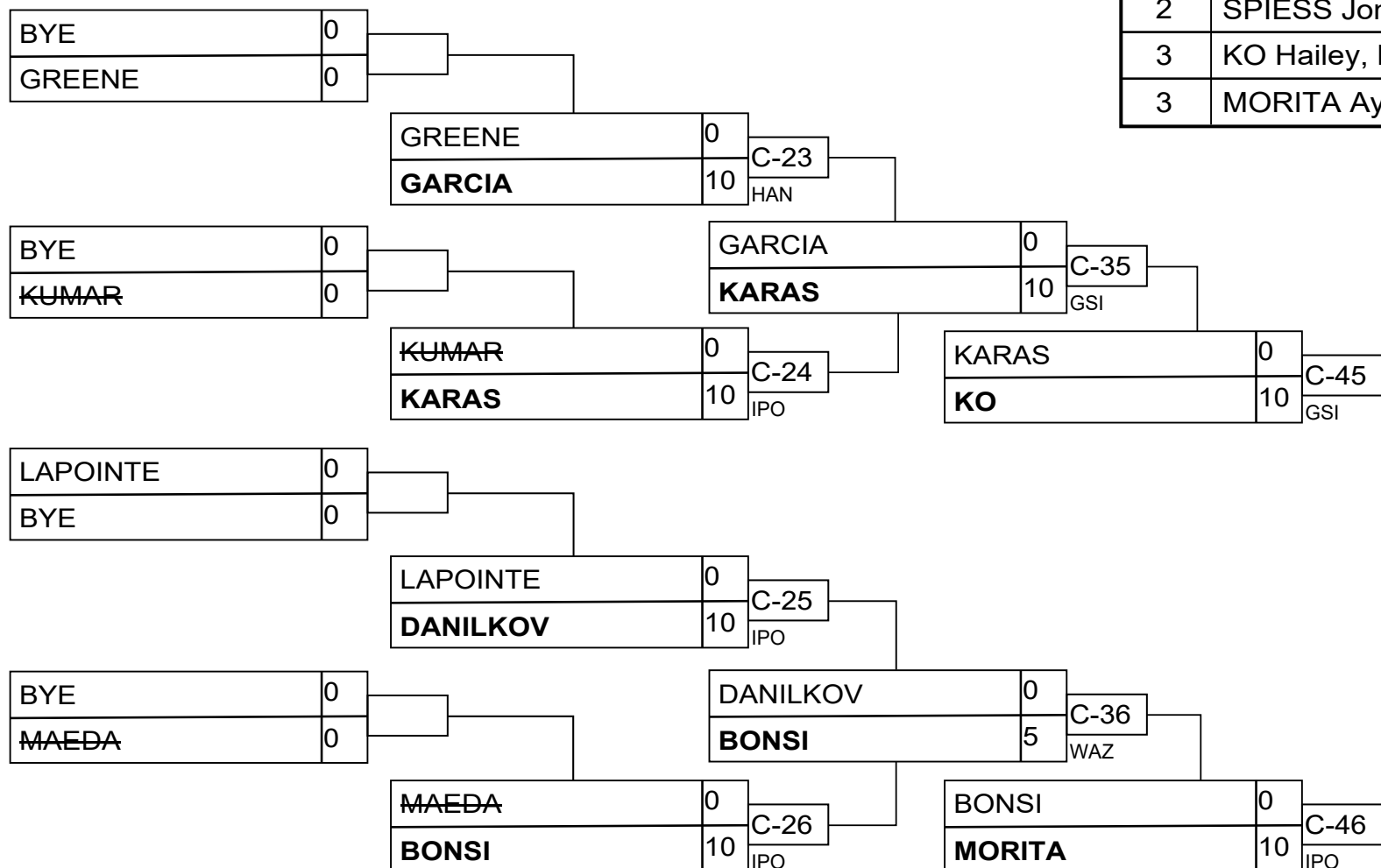

U21 Female -63kg

Competitors/Compétiteurs

#	Name/Nom	Grade	Club	1	2	3	4	5	W/G	Pts	Pos
1	MACDONALD Meadow	brown	AB/Lethbridge	XX	10				1	0	4
2	KINDERWATER Sydney	brown	AB/GP Martial Arts		XX			10	1	10	5
3	WESTLAKE Kiera	shodan	AB/Lethbridge	10	10	XX	10		3	30	2
4	EKOSKY Sarah	shodan	MB/Selkirk	10	5		XX		2	15	3
5	MANAILA Rebeca	brown	QC/Ippon	10		10	10	XX	3	30	1

Matches/Matches

Match	White/Blanc			Blue/Bleu	Res/Rés	Tim/Tmp	Code
A-11	EKOSKY Sarah	4	5	MANAILA Rebeca	0 - 10	2:49	IPO
A-13	MACDONALD Meadow	1	2	KINDERWATER Sydney	10 - 0	0:22	IPO
A-17	WESTLAKE Kiera	3	4	EKOSKY Sarah	10 - 0	2:50	WIP
A-18	MACDONALD Meadow	1	5	MANAILA Rebeca	0 - 10	2:19	DHM/HMD
A-24	KINDERWATER Sydney	2	3	WESTLAKE Kiera	0 - 10	2:48	IPO
A-25	MACDONALD Meadow	1	4	EKOSKY Sarah	0 - 10	0:00	FUS
A-35	WESTLAKE Kiera	3	5	MANAILA Rebeca	0 - 10	2:54	IPO
A-36	KINDERWATER Sydney	2	4	EKOSKY Sarah	0 - 5	5:01	GSW
A-44	MACDONALD Meadow	1	3	WESTLAKE Kiera	0 - 10	0:00	FUS
A-45	KINDERWATER Sydney	2	5	MANAILA Rebeca	10 - 0	0:49	IPO

Results/Résultats

Pos	Name/Nom
1	MANAILA Rebeca, QC/Ippon
2	WESTLAKE Kiera, AB/Lethbridge
3	EKOSKY Sarah, MB/Selkirk

U21 Female -70kg

Competitors/Compétiteurs

#	Name/Nom	Grade	Club	1	2	1	2	1	2	W/G	Pts	Pos
1	VILLA Rebecca	brown	MB/Nakamura	XX		XX		XX		0	0	2
2	LEFORT Alexandria	shodan	ON/Sheffield	10	XX	10	XX		XX	2	20	1

Matches/Matches

Match	White/Blanc			Blue/Bleu	Res/Rés	Tim/Tmp	Code
A-26	VILLA Rebecca	1	2	LEFORT Alexandria	0 - 10	0:18	IPO
A-37	LEFORT Alexandria	2	1	VILLA Rebecca	10 - 0	0:32	WIP
A-46	VILLA Rebecca	1	2	LEFORT Alexandria			

Results/Résultats

Pos	Name/Nom
1	LEFORT Alexandria, ON/Sheffield

Competitors/Compétiteurs A

#	Name/Nom	Grade	Club	1	2	3	4	W/G	Pts	Pos
1	CYR Spencer	brown	BC/Abbotsford	XX	10			1	10	3
2	ORTIZ Jonathan	green	UW Judo		XX			0	0	4
3	ANDRAS Norbert Peter	brown	QC/Ippon	10	10	XX	10	3	30	1
4	COLLIN Tylor	shodan	NB/Club Judo Otoshi	10	10		XX	2	20	2

Pool A

Match	White/Blanc	Blue/Bleu	Res/Rés	Tim/Tmp	Code
D-8	CYR Spencer 1	ORTIZ Jonathan 2	10 - 0	0:23	IPO
D-9	ANDRAS Norbert Peter 3	COLLIN Tylor 4	10 - 0	4:05	GSI
D-20	CYR Spencer 1	ANDRAS Norbert Peter 3	0 - 10	0:44	IPO
D-21	ORTIZ Jonathan 2	COLLIN Tylor 4	0 - 10	0:10	IPO
D-32	CYR Spencer 1	COLLIN Tylor 4	0 - 10	0:44	IPO
D-33	ORTIZ Jonathan 2	ANDRAS Norbert Peter 3	0 - 10	0:14	IPO

Competitors/Compétiteurs B

#	Name/Nom	Grade	Club	5	6	7	W/G	Pts	Pos
5	LOWE Jacob	brown	BC/Victoria	XX			0	0	3
6	DESBIENS Alexandre	shodan	QC/Jonquière	10	XX		1	10	2
7	DESSUREAUT Victor	brown	C102 Club judokas Jonqui	10	10	XX	2	20	1

Pool B

Match	White/Blanc	Blue/Bleu	Res/Rés	Tim/Tmp	Code
D-10	LOWE Jacob 5	DESBIENS Alexandre 6	0 - 10	2:43	IPO
D-22	LOWE Jacob 5	DESSUREAUT Victor 7	0 - 10	0:11	IPO
D-34	DESBIENS Alexandre 6	DESSUREAUT Victor 7	0 - 10	2:30	IPO

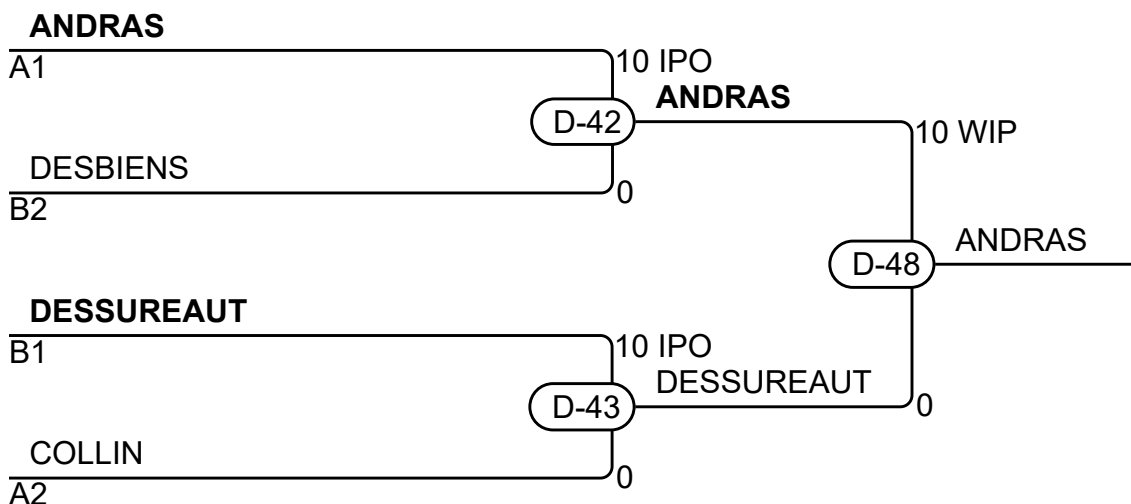

Results/Résultats

Pos	Name/Nom
1	ANDRAS Norbert Peter, QC/Ippon
2	DESSUREAUT Victor, C102 Club judokas Jonquière
3	DESBIENS Alexandre, QC/Jonquière
3	COLLIN Tylor, NB/Club Judo Otoshi

U21 Male -66kg

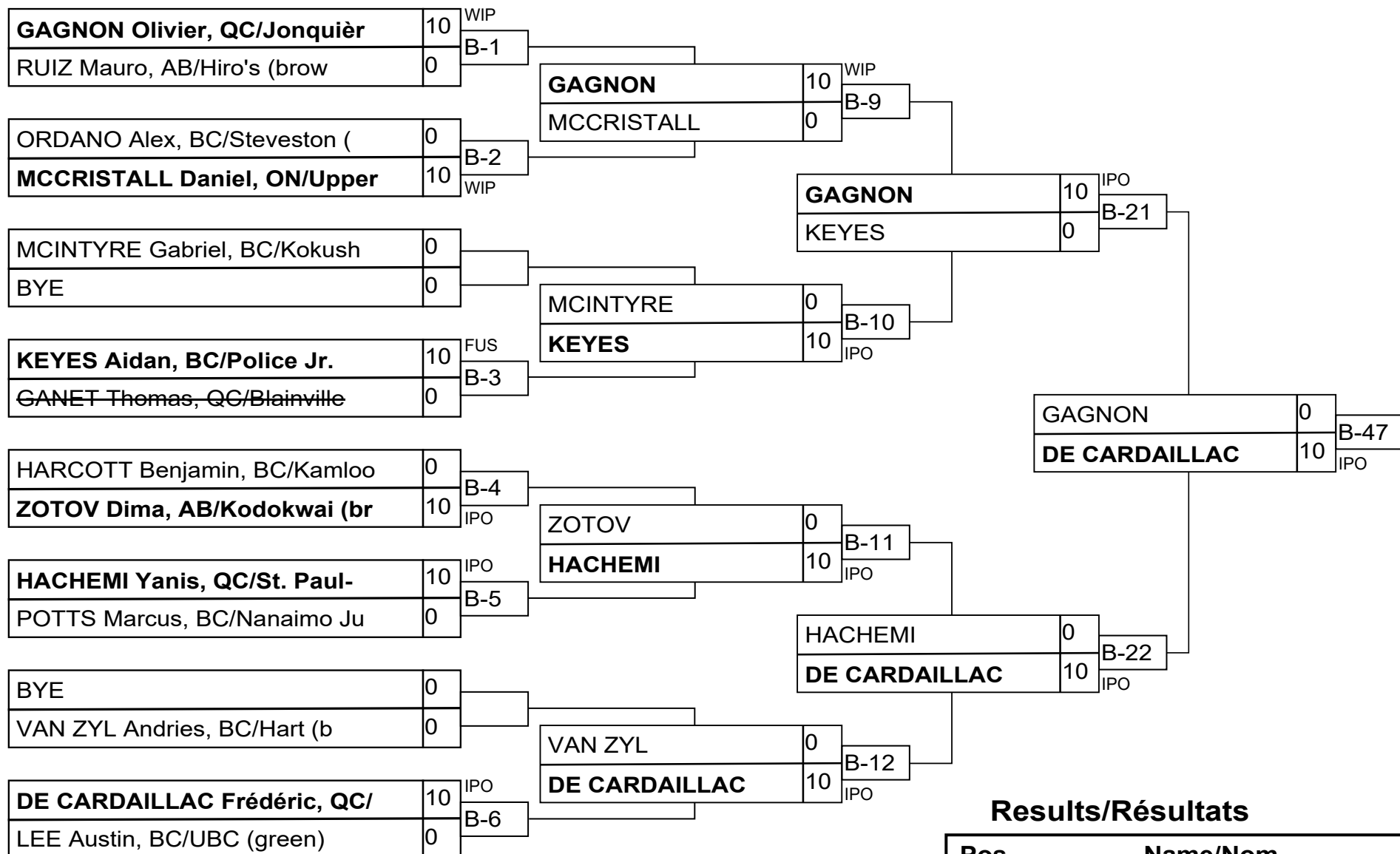

Results/Résultats

Pos	Name/Nom
1	DE CARDAILLAC Frédéric,
2	GAGNON Olivier, QC/Jonqu
3	ZOTOV Dima, AB/Kodokwai
3	HACHEMI Yanis, QC/St. Pa

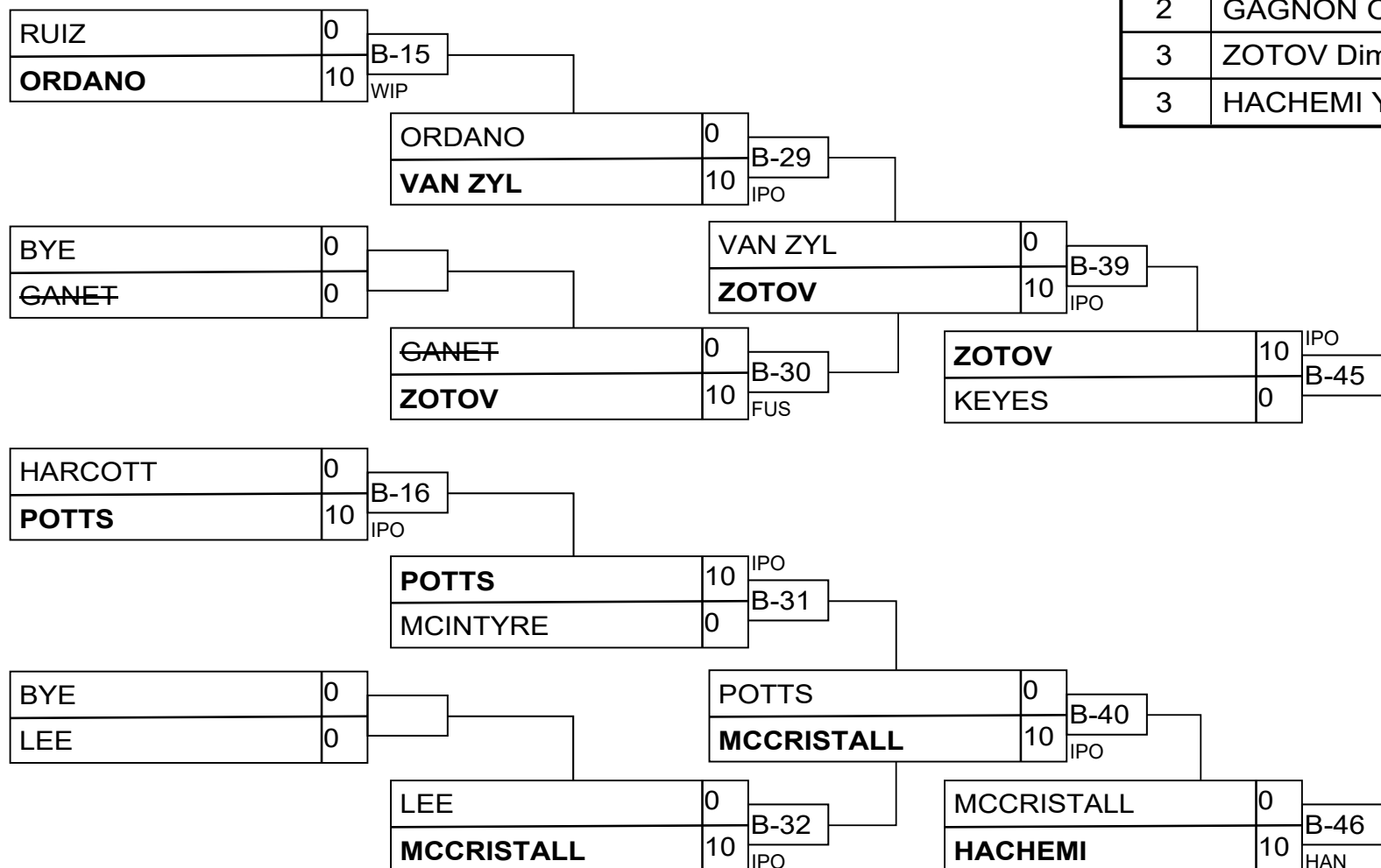

U21 Male -73kg

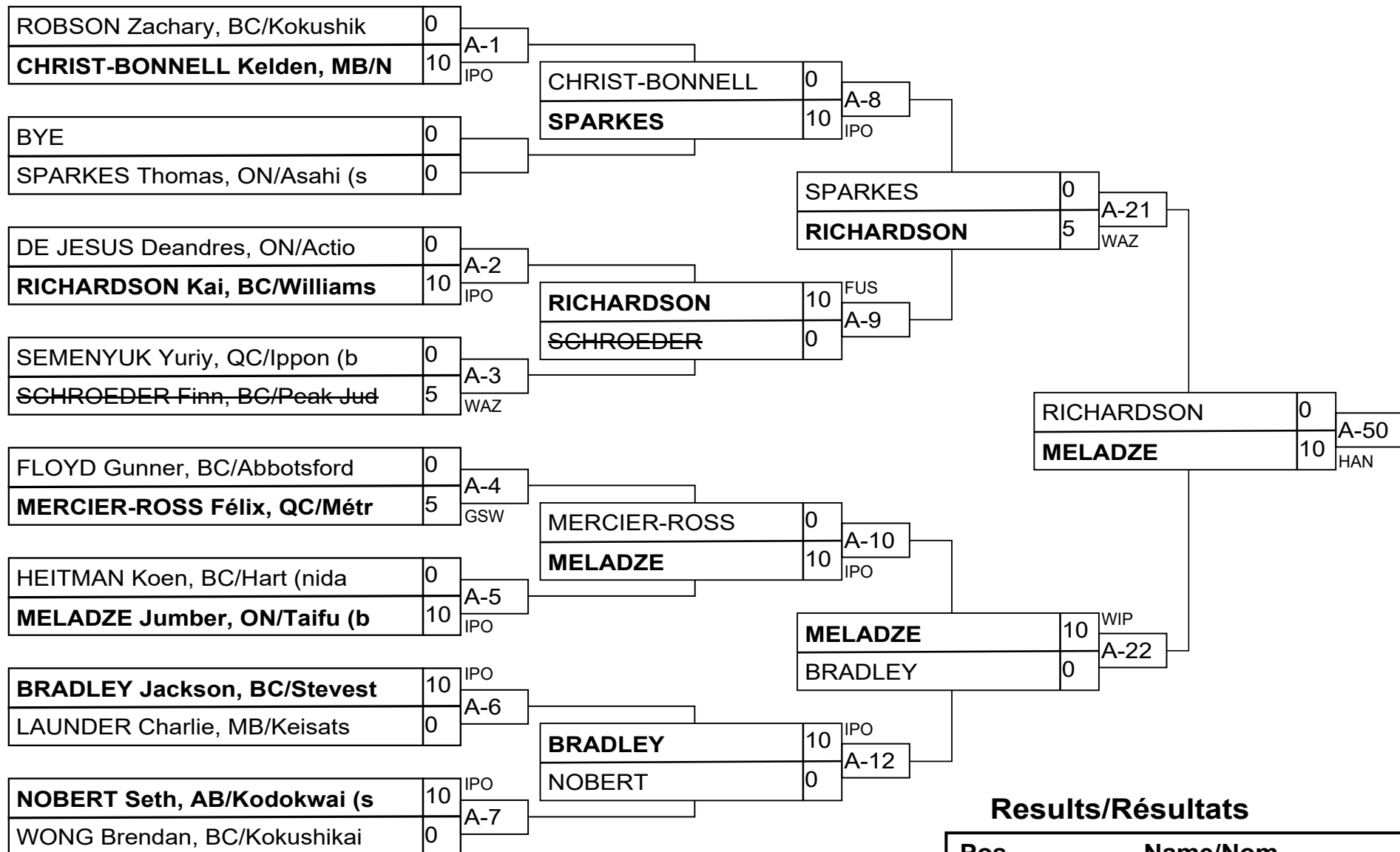

Results/Résultats

Pos	Name/Nom
1	MELADZE Jumber, ON/Taifu
2	RICHARDSON Kai, BC/Willi
3	NOBERT Seth, AB/Kodokwai
3	BRADLEY Jackson, BC/Stev

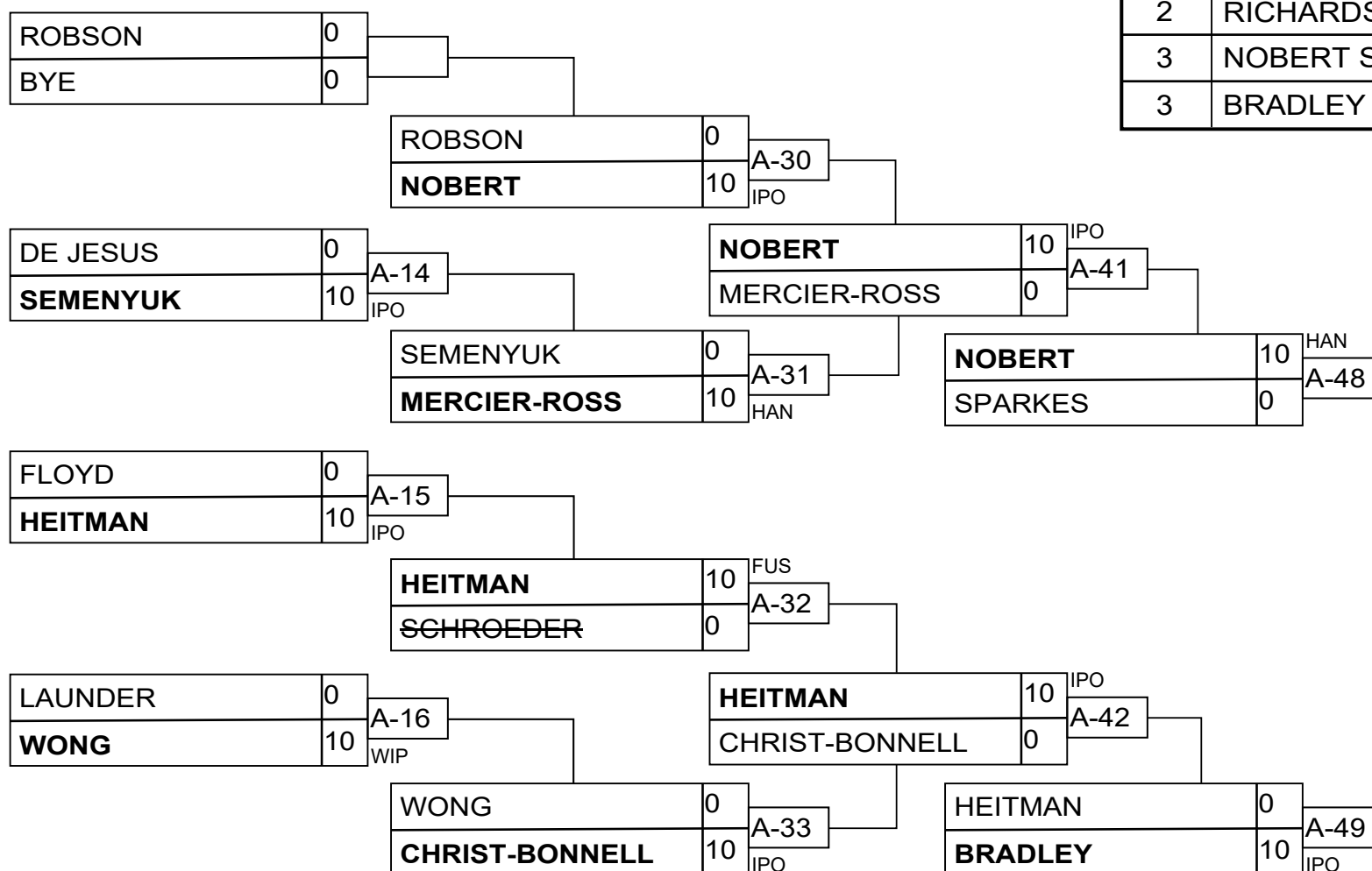

Competitors/Compétiteurs A

#	Name/Nom	Grade	Club	1	2	3	4	W/G	Pts	Pos
1	CHEVALIER Louis	shodan	ON/Hayabusakan	XX	10			1	10	3
2	JING Pierce	shodan	BC/Steveston		XX			0	0	4
3	ANDRIAMANANA Faniry-Michaë	brown	QC/St. Hyacinthe	10	10	XX		2	20	2
4	ALTHOUSE Carter	brown	AB/Lethbridge	10	10	5	XX	3	25	1

Pool A

Match	White/Blanc	Blue/Bleu	Res/Rés	Tim/Tmp	Code
D-3	CHEVALIER Louis 1 2	JING Pierce	10 - 0	0:33	IPO
D-4	ANDRIAMANANA Faniry-Michaël 3 4	ALTHOUSE Carter	0 - 5	4:00	WAZ
D-17	CHEVALIER Louis 1 3	ANDRIAMANANA Faniry-Michaël	0 - 10	1:13	WIP
D-18	JING Pierce 2 4	ALTHOUSE Carter	0 - 10	4:30	GSI
D-29	CHEVALIER Louis 1 4	ALTHOUSE Carter	0 - 10	1:12	IPO
D-30	JING Pierce 2 3	ANDRIAMANANA Faniry-Michaël	0 - 10	0:24	IPO

Competitors/Compétiteurs B

#	Name/Nom	Grade	Club	5	6	7	W/G	Pts	Pos
5	CRAEVOI Victor	brown	AB/Kodokwai	XX	10	10	2	20	1
6	SHAPORIN Artem	brown	QC/Ippon		XX		0	0	3
7	GAULIN Guillaume	shodan	QC/Juvaldo		10	XX	1	10	2

Pool B

Match	White/Blanc	Blue/Bleu	Res/Rés	Tim/Tmp	Code
D-5	CRAEVOI Victor 5 6	SHAPORIN Artem	10 - 0	2:41	WIP
D-19	CRAEVOI Victor 5 7	GAULIN Guillaume	10 - 0	0:39	IPO
D-31	SHAPORIN Artem 6 7	GAULIN Guillaume	0 - 10	0:28	IPO

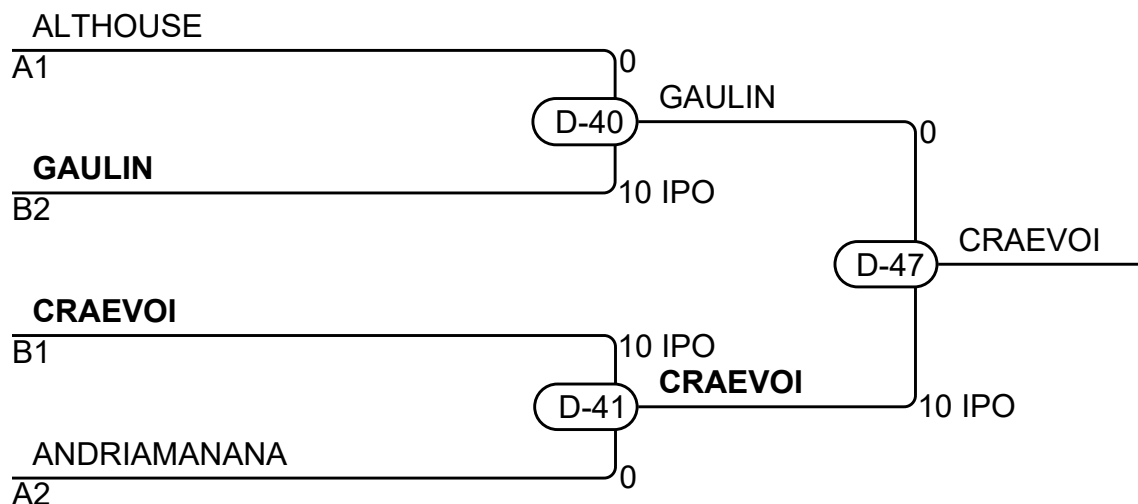

Results/Résultats

Pos	Name/Nom
1	CRAEVOI Victor, AB/Kodokwai
2	GAULIN Guillaume, QC/Juvaldo
3	ALTHOUSE Carter, AB/Lethbridge
3	ANDRIAMANANA Faniry-Michaël, QC/St. Hyacinthe

U21 Male -90kg

Competitors/Compétiteurs

#	Name/Nom	Grade	Club	1	2	3	W/G	Pts	Pos
1	NETTLES Dashiell	blue	BC/Kamloops	XX			0	0	3
2	GARAND Alec	brown	QC/Zenshin	10	XX	5	2	15	1
3	GODBOUT Xavier	brown	AB/Hiro's	10		XX	1	10	2

Matches/Matches

Match	White/Blanc			Blue/Bleu	Res/Rés	Tim/Tmp	Code
C-5	NETTLES Dashiell	1	2	GARAND Alec	0 - 10	0:16	IPO
C-29	NETTLES Dashiell	1	3	GODBOUT Xavier	0 - 10	0:38	IPO
C-39	GARAND Alec	2	3	GODBOUT Xavier	5 - 0	4:00	WAZ

Results/Résultats

Pos	Name/Nom
1	GARAND Alec, QC/Zenshin
2	GODBOUT Xavier, AB/Hiro's

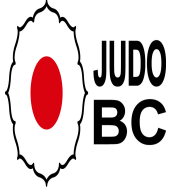

U21 Male +100kg



Competitors/Compétiteurs

#	Name/Nom	Grade	Club	1	2	1	2	1	2	W/G	Pts	Pos
1	VELASQUEZ KASAP Abel	green	BC/Police Jr.	XX		XX		XX		0	0	2
2	AKBASHEV Michael	shodan	MB/BP Judo club	10	XX	10	XX		XX	2	20	1

Matches/Matches

Match	White/Blanc			Blue/Bleu	Res/Rés	Tim/Tmp	Code
A-27	VELASQUEZ KASAP Abel	1	2	AKBASHEV Michael	0 - 10	0:24	IPO
A-38	AKBASHEV Michael	2	1	VELASQUEZ KASAP Abel	10 - 0	1:43	IPO
A-47	VELASQUEZ KASAP Abel	1	2	AKBASHEV Michael			

Results/Résultats

Pos	Name/Nom
1	AKBASHEV Michael, MB/BP Judo club