

# SF -48kg

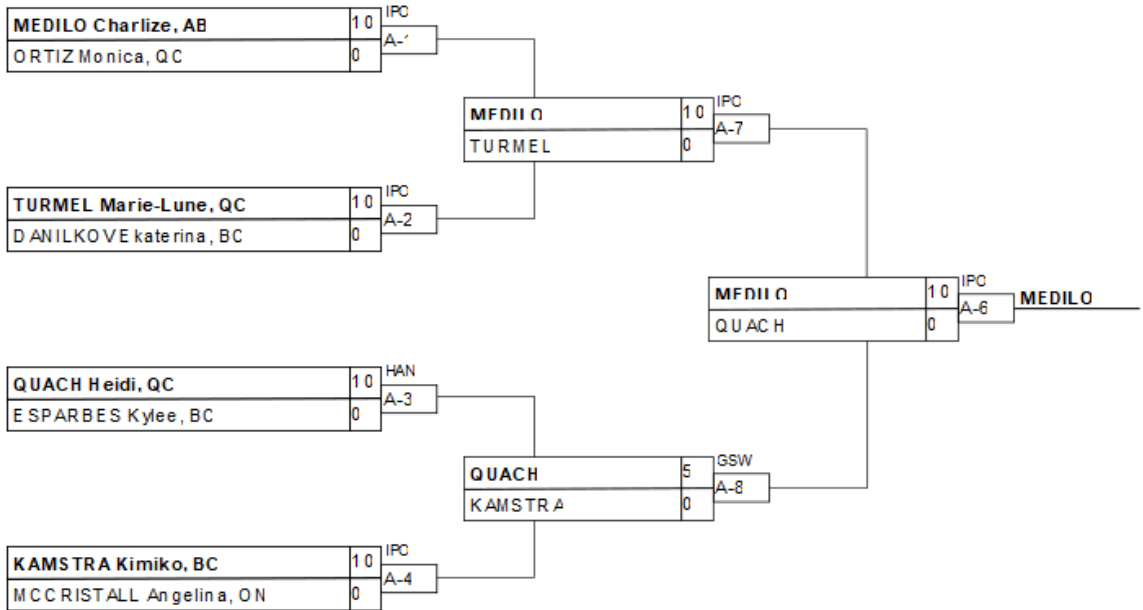

## Results/Résultats

Pos	Name/Nom
1	MEDIL O Charlize, AB
2	QUACH Heidi, QC
3	TURMEL Marie-Lune, QC
3	ORTIZ Monica, QC

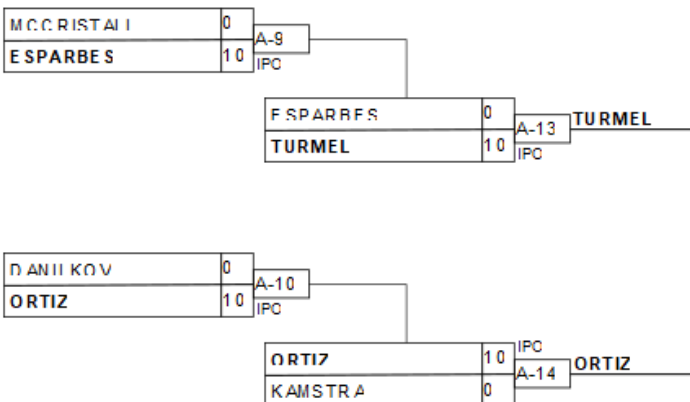

# SF -52kg

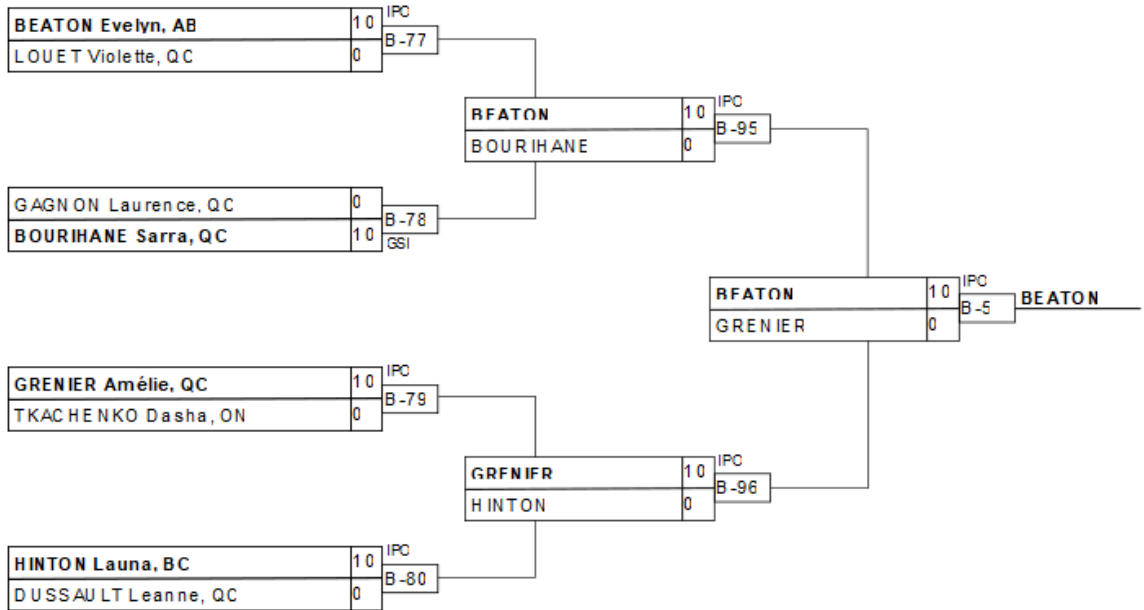

## Results/Résultats

Pos	Name/Nom
1	BEATON Evelyn, AB
2	GRENIER Amélie, QC
3	BOURIHANE Sarra, QC
3	HINTON Launa, BC

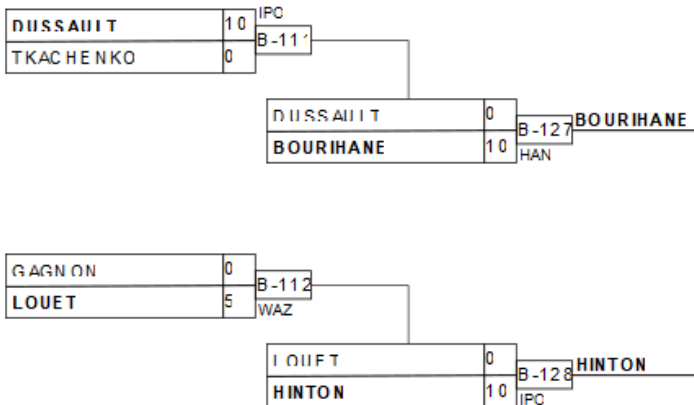

# SF -57kg

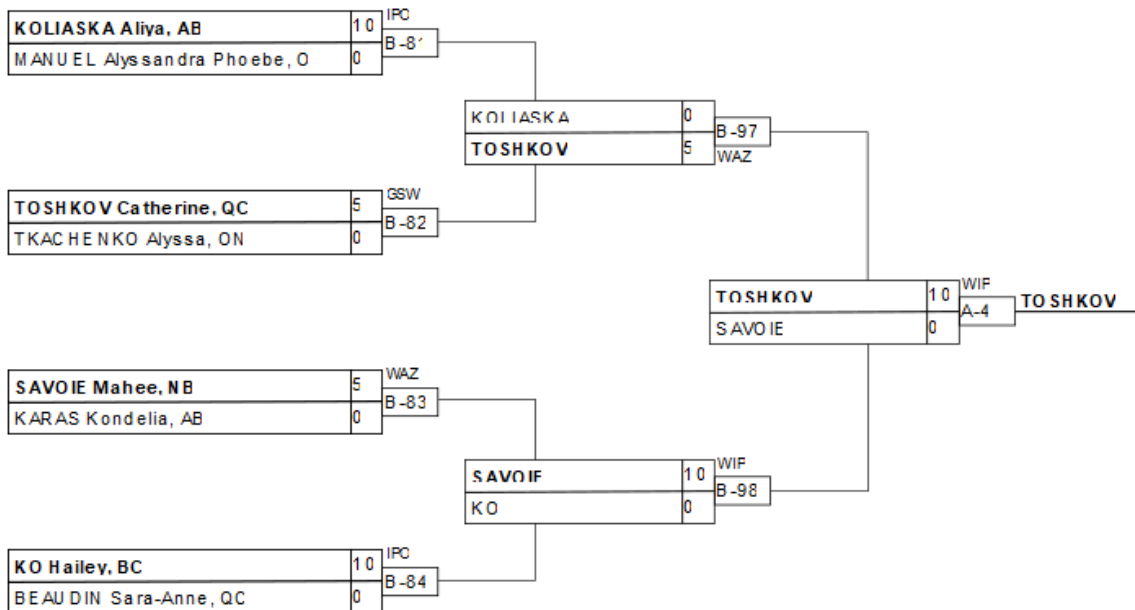

## Results/Résultats

Pos	Name/Nom
1	TOSHKOV Catherine, QC
2	SAVOIE Mahee, NB
3	KOLIASKA Aliya, AB
3	MANUEL Alysandra Phoebe

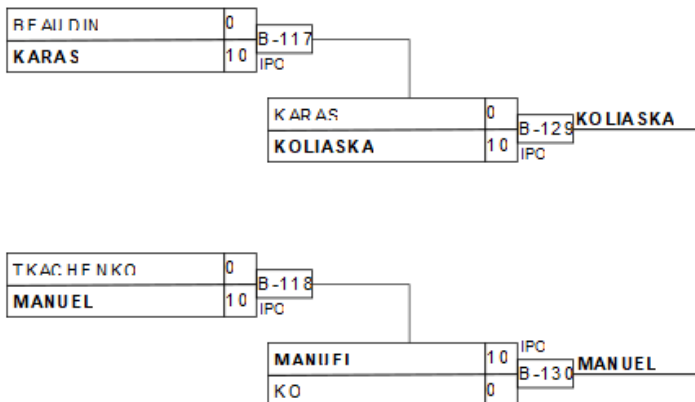

# SF -63kg

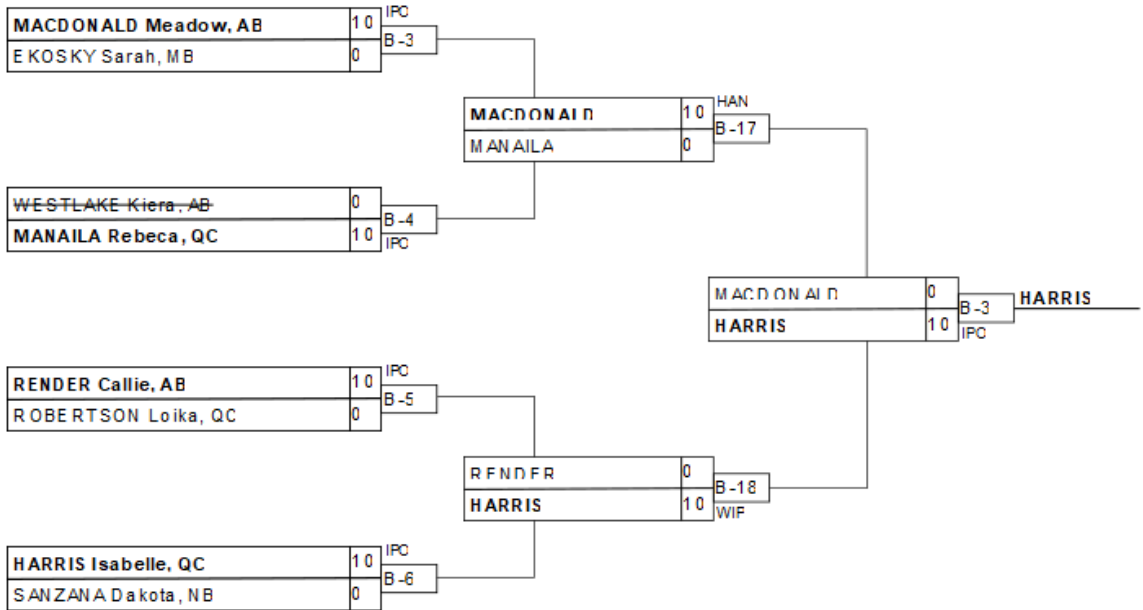

## Results/Résultats

Pos	Name/Nom
1	HARRIS Isabelle, QC
2	MACDONALD Meadow, AB
3	MANAILA Rebeca, QC
3	EKOSKY Sarah, MB

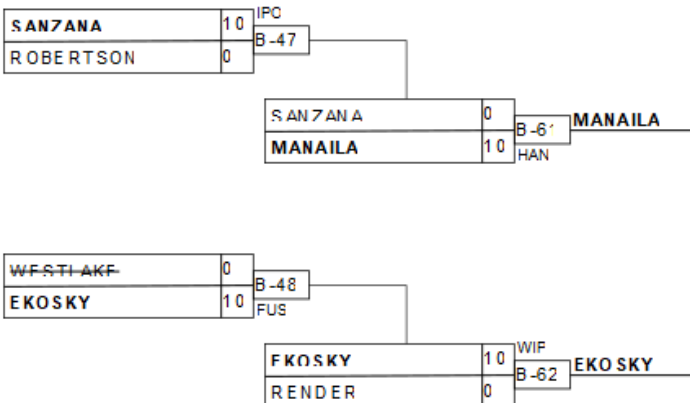

# SF -70kg

## Competitors/Compétiteurs A

#	Name/Nom	Club	1	2	3	4	W/G	Pts	Pos
1	FIANDOR Alicia	BC	XX				0	0	4
2	LEFORT Alexandria	ON	10	XX	5	10	3	25	1
3	BURT Kiera	ON	10		XX	10	2	20	2
4	BOURQUE Charline	QC	10			XX	1	10	3

## Pool A

Match	White/Blanc	Blue/Bleu	Res/Rés	Tim/Tmp	Code
B-10	FIANDOR Alicia 1 2	LEFORT Alexandria	0 - 10	3:37	IPO
B-11	BURT Kiera 3 4	BOURQUE Charline	10 - 0	0:39	IPO
B-24	FIANDOR Alicia 1 3	BURT Kiera	0 - 10	1:01	IPO
B-25	LEFORT Alexandria 2 4	BOURQUE Charline	10 - 0	1:56	WIP
B-38	FIANDOR Alicia 1 4	BOURQUE Charline	0 - 10	0:00	FUS
B-39	LEFORT Alexandria 2 3	BURT Kiera	5 - 0	4:09	GSW

## Competitors/Compétiteurs B

#	Name/Nom	Club	5	6	7	W/G	Pts	Pos
5	ROTBART Nova	BC	XX			0	0	3
6	BIRON Laurence	QC	10	XX	10	2	20	1
7	BATBAYAR Maralgoo	AB	10		XX	1	10	2

## Pool B

Match	White/Blanc	Blue/Bleu	Res/Rés	Tim/Tmp	Code
B-12	ROTBART Nova 5 6	BIRON Laurence	0 - 10	2:33	WIP
B-26	ROTBART Nova 5 7	BATBAYAR Maralgoo	0 - 10	3:29	HAN
B-40	BIRON Laurence 6 7	BATBAYAR Maralgoo	10 - 0	1:30	IPO

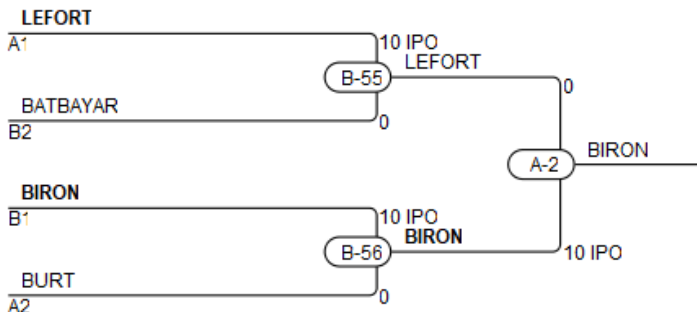

## Results/Résultats

Pos	Name/Nom
1	BIRON Laurence, QC
2	LEFORT Alexandria, ON
3	BATBAYAR Maralgoo, AB
3	BURT Kiera, ON

# SF -78kg

## Competitors/Compétiteurs

#	Name/Nom	Club	1	2	3	W/G	Pts	Pos
1	FOWLER Naomi	NB	XX			0	0	3
2	LAVIGNE Frederique	QC	10	XX		1	10	2
3	GODBOUT Coralie	QC	10	10	XX	2	20	1

## Matches/Matches

Match	White/Blanc			Blue/Bleu	Res/Rés	Tim/Tmp	Code
B-16	FOWLER Naomi	1	2	LAVIGNE Frederique	0 - 10	1:34	IPO
B-30	FOWLER Naomi	1	3	GODBOUT Coralie	0 - 10	0:52	IPO
B-46	LAVIGNE Frederique	2	3	GODBOUT Coralie	0 - 10	1:49	IPO

## Results/Résultats

Pos	Name/Nom
1	GODBOUT Coralie, QC
2	LAVIGNE Frederique, QC

# SF +78kg

## Competitors/Compétiteurs A

#	Name/Nom	Club	1	2	3	4	W/G	Pts	Pos
1	BISSON Charlie	QC	XX				0	0	4
2	LINGLEY Brandi	NB	10	XX	10	10	3	30	1
3	DESBIENS Sara	QC	10		XX	10	2	20	2
4	KARAS Marianna	AB	10			XX	1	10	3

## Pool A

Match	White/Blanc	Blue/Bleu	Res/Rés	Tim/Tmp	Code
B-13	BISSON Charlie 1 2	LINGLEY Brandi	0 - 10	1:13	WIP
B-14	DESBIENS Sara 3 4	KARAS Marianna	10 - 0	1:13	IPO
B-27	BISSON Charlie 1 3	DESBIENS Sara	0 - 10	0:51	IPO
B-28	LINGLEY Brandi 2 4	KARAS Marianna	10 - 0	1:37	IPO
B-41	BISSON Charlie 1 4	KARAS Marianna	0 - 10	1:22	WIP
B-42	LINGLEY Brandi 2 3	DESBIENS Sara	10 - 0	2:14	IPO

## Competitors/Compétiteurs B

#	Name/Nom	Club	5	6	7	W/G	Pts	Pos
5	KEYS Jannessa	SK	XX	10		1	10	2
6	MCALPINE Amanda	ON		XX		0	0	3
7	PORTUONDO-ISASI Adriana	QC	10	10	XX	2	20	1

## Pool B

Match	White/Blanc	Blue/Bleu	Res/Rés	Tim/Tmp	Code
B-15	KEYS Jannessa 5 6	MCALPINE Amanda	10 - 0	0:30	WIP
B-29	KEYS Jannessa 5 7	PORTUONDO-ISASI Adriana	0 - 10	0:13	IPO
B-45	MCALPINE Amanda 6 7	PORTUONDO-ISASI Adriana	0 - 10	0:28	WIP

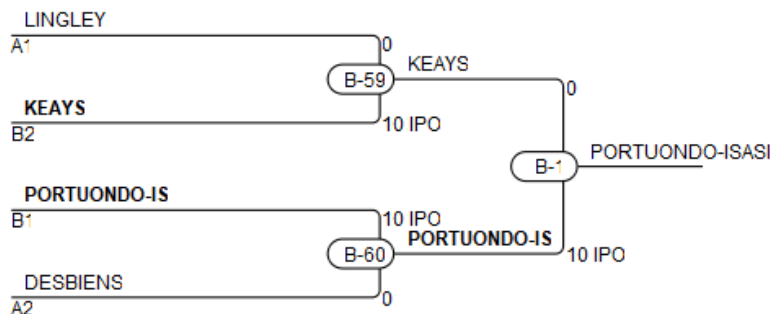

## Results/Résultats

Pos	Name/Nom
1	PORTUONDO-ISASI Adriana, QC
2	KEYS Jannessa, SK
3	LINGLEY Brandi, NB
3	DESBIENS Sara, QC

# SM -100kg

## Competitors/Compétiteurs A

#	Name/Nom	Club	1	2	3	4	W/G	Pts	Pos
1	ROCHELEAU Danick	QC	XX				0	0	4
2	MALVENISHVILI Iliia	ON	10	XX		10	2	20	2
3	PETROVIC Nikola	BC	10	10	XX	10	3	30	1
4	HALLETT Josiah	SK	10			XX	1	10	3

## Pool A

Match	White/Blanc			Blue/Bleu	Res/Rés	Tim/Tmp	Code
B-1	ROCHELEAU Danick	1	2	MALVENISHVILI Iliia	0 - 10	0:00	IPO
B-2	PETROVIC Nikola	3	4	HALLETT Josiah	10 - 0	0:26	IPO
B-19	ROCHELEAU Danick	1	3	PETROVIC Nikola	0 - 10	0:00	FUS
B-20	MALVENISHVILI Iliia	2	4	HALLETT Josiah	10 - 0	0:29	WIP
B-31	ROCHELEAU Danick	1	4	HALLETT Josiah	0 - 10	0:00	FUS
B-32	MALVENISHVILI Iliia	2	3	PETROVIC Nikola	0 - 10	1:48	IPO

## Competitors/Compétiteurs B

#	Name/Nom	Club	5	6	7	W/G	Pts	Pos
5	TURCOTTE Kevin	QC	XX		5	1	5	2
6	NEYOLOV Danil	ON	10	XX	10	2	20	1
7	AKBASHEV Michael	MB			XX	0	0	3

## Pool B

Match	White/Blanc			Blue/Bleu	Res/Rés	Tim/Tmp	Code
B-7	TURCOTTE Kevin	5	6	NEYOLOV Danil	0 - 10	2:49	IPO
B-21	TURCOTTE Kevin	5	7	AKBASHEV Michael	5 - 0	4:42	GSW
B-33	NEYOLOV Danil	6	7	AKBASHEV Michael	10 - 0	3:12	IPO

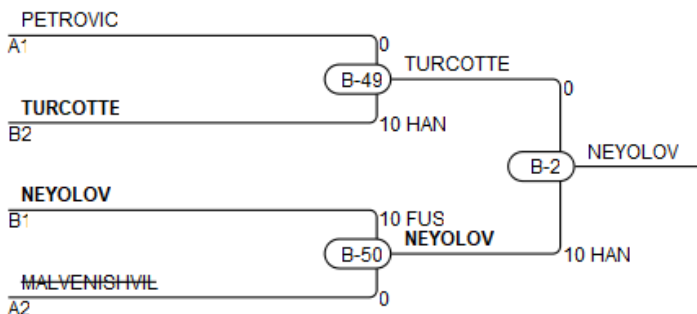

## Results/Résultats

Pos	Name/Nom
1	NEYOLOV Danil, ON
2	TURCOTTE Kevin, QC
3	PETROVIC Nikola, BC
3	MALVENISHVILI Iliia, ON



# SM -60kg

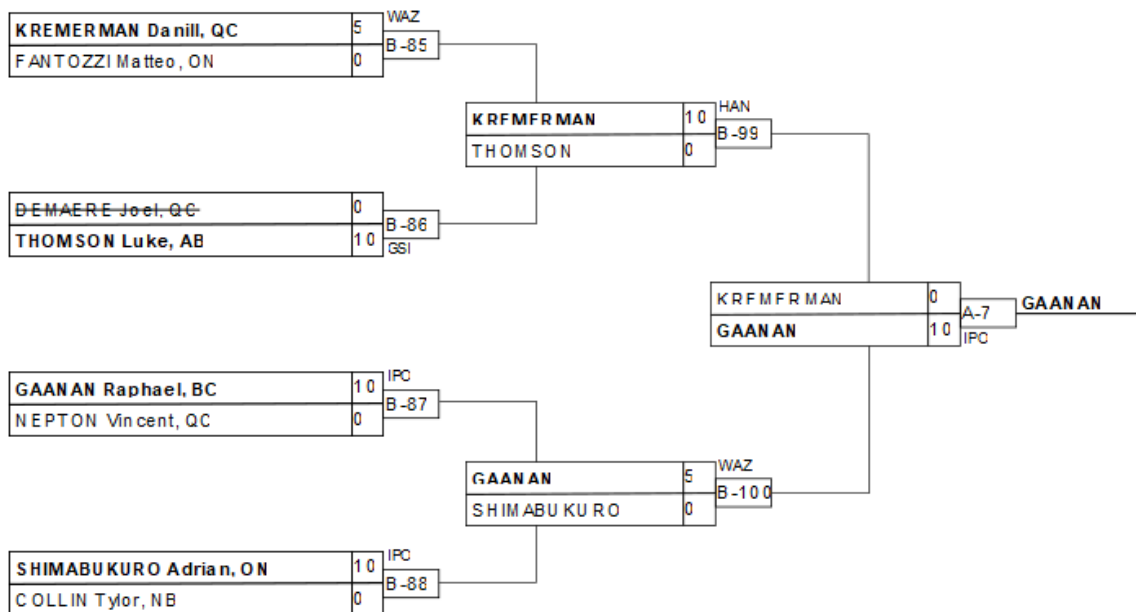

## Results/Résultats

Pos	Name/Nom
1	GAANAN Raphael, BC
2	KREMERMANN Danill, QC
3	NEPTON Vincent, QC
3	SHIMABUKURO Adrian, ON

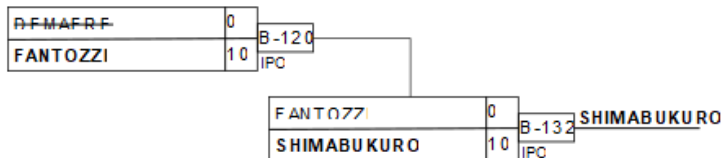
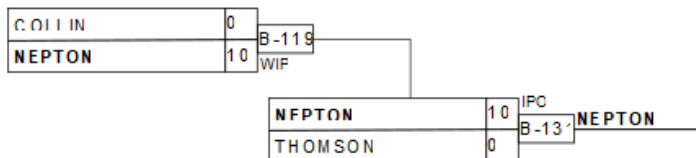

# SM -66kg

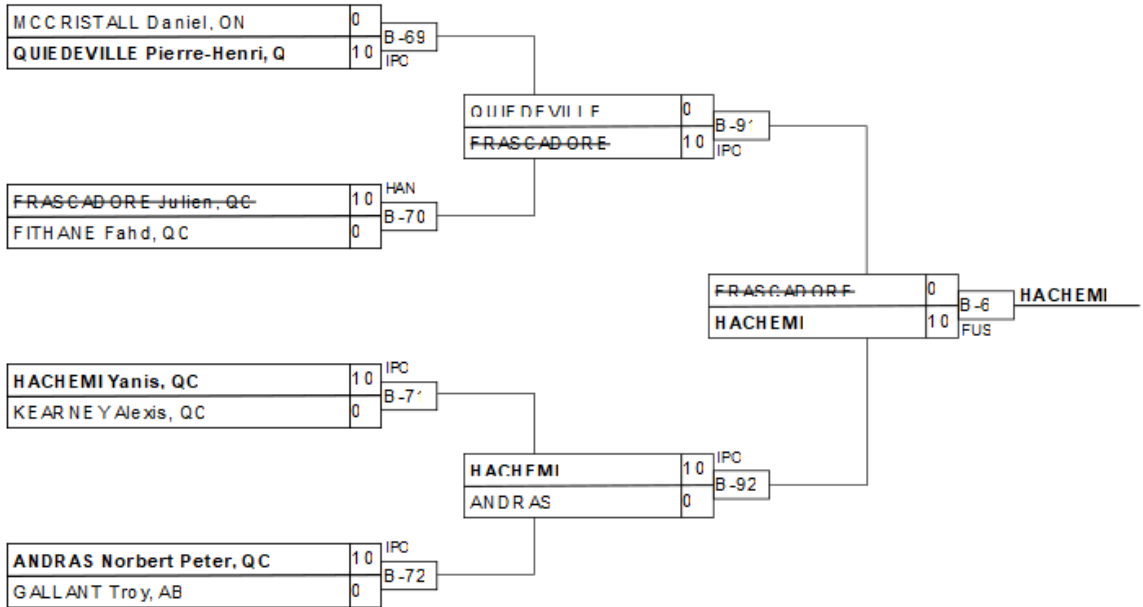

## Results/Résultats

Pos	Name/Nom
1	HACHEMI Yanis, QC
2	
3	QUIEDEVILLE Pierre-Henri
3	ANDRAS Norbert Peter, QC

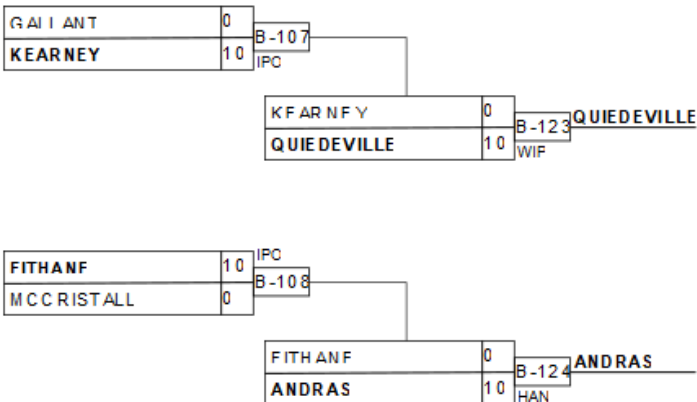

# SM -73kg

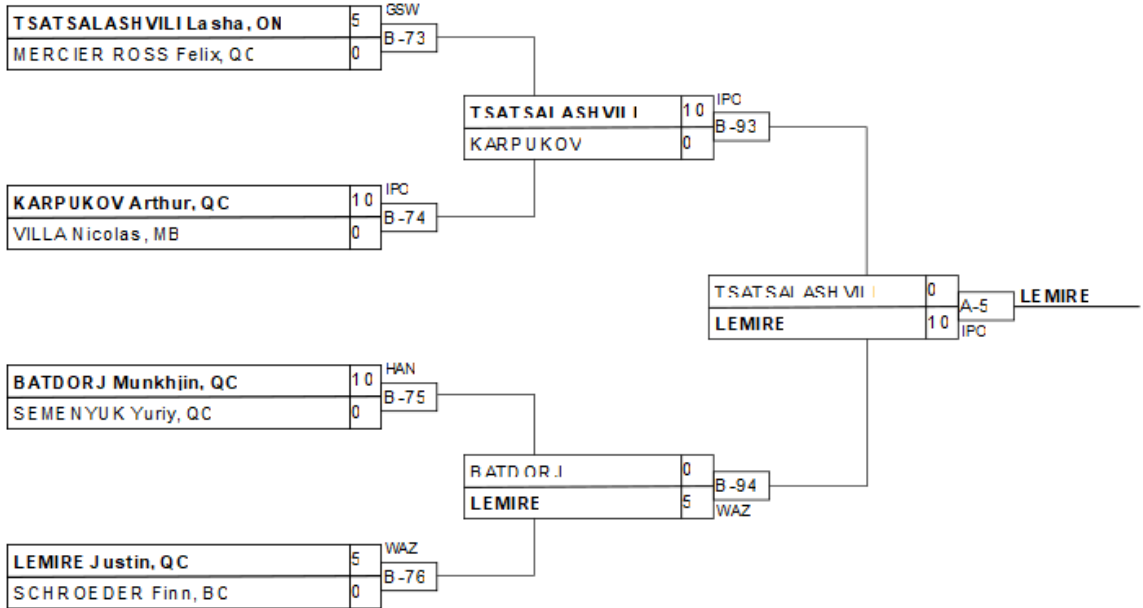

## Results/Résultats

Pos	Name/Nom
1	LEMIRE Justin, QC
2	TSATSALASHVILI Lasha, ON
3	KARPUKOV Arthur, QC
3	BATDORJ Munkhjin, QC

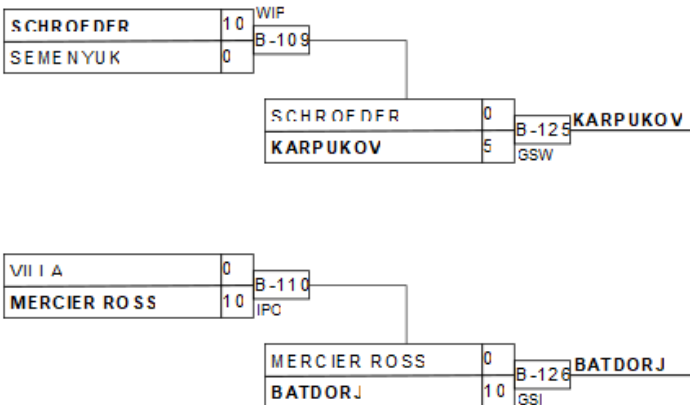

# SM -81kg

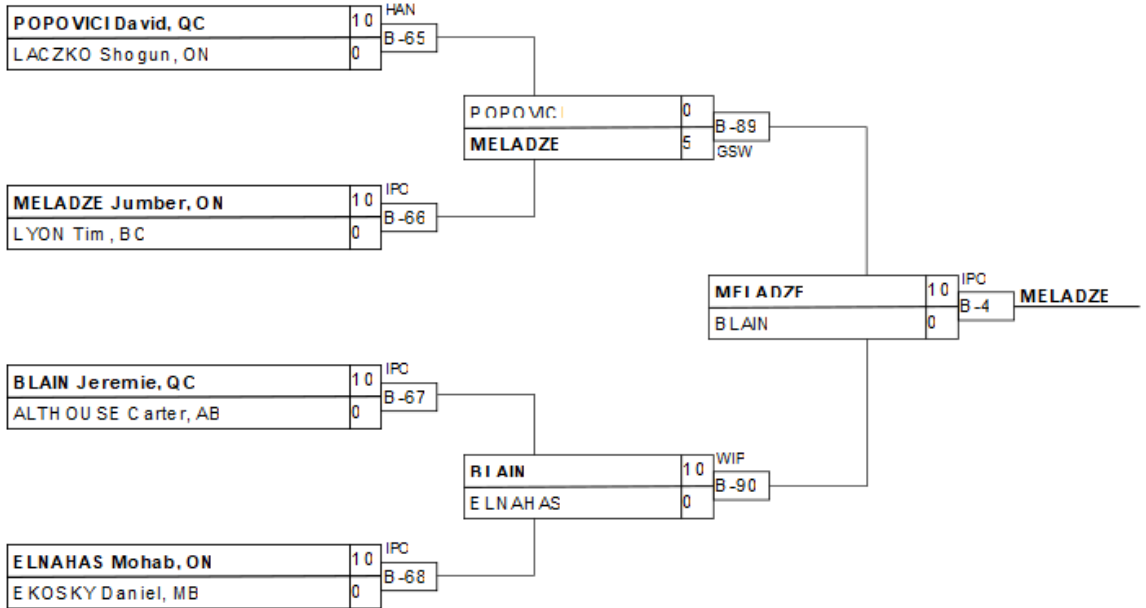

## Results/Résultats

Pos	Name/Nom
1	MELADZE Jumber, ON
2	BLAIN Jeremie, QC
3	POPOVICI David, QC
3	ELNAHAS Mohab, ON

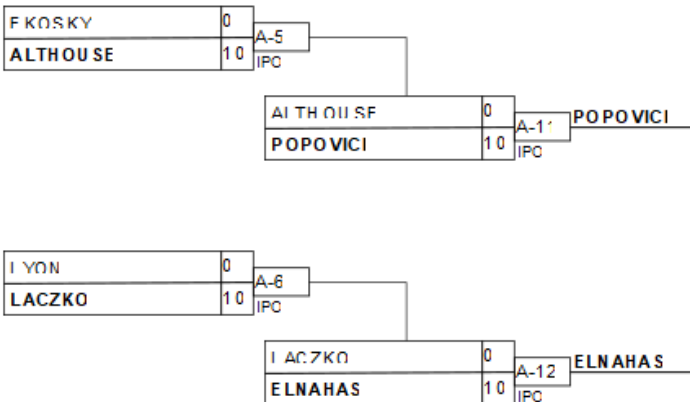

# SM -90kg

## Competitors/Compétiteurs A

#	Name/Nom	Club	1	2	3	W/G	Pts	Pos
1	MADUMBA George	PE	XX			0	0	3
2	GARAND Alec	QC	5	XX		1	5	2
3	GAULIN Guillaume	QC	10	10	XX	2	20	1

## Pool A

Match	White/Blanc		Blue/Bleu	Res/Rés	Tim/Tmp	Code
B-8	MADUMBA George	1 2	GARAND Alec	0 - 5	4:00	WAZ
B-22	MADUMBA George	1 3	GAULIN Guillaume	0 - 10	0:27	IPO
B-34	GARAND Alec	2 3	GAULIN Guillaume	0 - 10	3:53	IPO

## Competitors/Compétiteurs B

#	Name/Nom	Club	4	5	6	W/G	Pts	Pos
4	SEIB Warren	SK	XX		10	1	10	2
5	ARENCIBIA Alexandre	QC	10	XX	10	2	20	1
6	GODBOUT Xavier	QC			XX	0	0	3

## Pool B

Match	White/Blanc		Blue/Bleu	Res/Rés	Tim/Tmp	Code
B-9	SEIB Warren	4 5	ARENCIBIA Alexandre	0 - 10	2:52	HAN
B-23	SEIB Warren	4 6	GODBOUT Xavier	10 - 0	1:17	IPO
B-35	ARENCIBIA Alexandre	5 6	GODBOUT Xavier	10 - 0	1:03	IPO

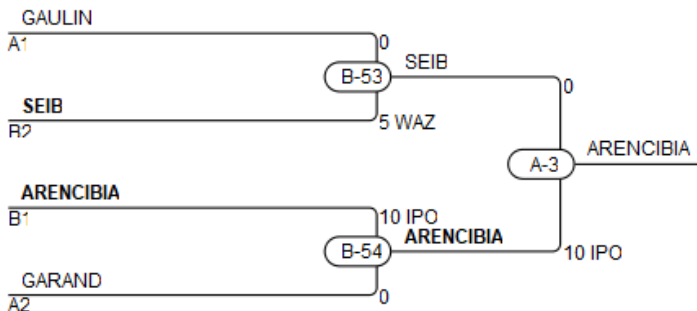

## Results/Résultats

Pos	Name/Nom
1	ARENCIBIA Alexandre, QC
2	SEIB Warren, SK
3	GAULIN Guillaume, QC
3	GARAND Alec, QC

# SM +100kg

## Competitors/Compétiteurs

#	Name/Nom	Club	1	2	3	4	5	W/G	Pts	Pos
1	POULIN-LABELLE Maxime	QC	XX					0	0	5
2	MESSE A BESSONG John Jr	QC	10	XX	10	10		3	30	2
3	BLANEY Andrew	NB	10		XX	10		2	20	3
4	BELAL Rayan	QC	10			XX		1	10	4
5	DESCHENES Marc	QC	10	10	10	10	XX	4	40	1

## Matches/Matches

Match	White/Blanc			Blue/Bleu	Res/Rés	Tim/Tmp	Code
B-36	BELAL Rayan	4	5	DESCHENES Marc	0 - 10	1:07	IPO
B-37	POULIN-LABELLE Maxime	1	2	MESSE A BESSONG John Jr	0 - 10	3:14	HAN
B-43	<b>BLANEY Andrew</b>	3	4	BELAL Rayan	10 - 0	2:05	IPO
B-44	POULIN-LABELLE Maxime	1	5	DESCHENES Marc	0 - 10	0:00	FUS
B-51	<b>MESSE A BESSONG John Jr</b>	2	3	BLANEY Andrew	10 - 0	1:34	HAN
B-52	POULIN-LABELLE Maxime	1	4	<b>BELAL Rayan</b>	0 - 10	0:00	FUS
B-57	BLANEY Andrew	3	5	DESCHENES Marc	0 - 10	0:40	WIP
B-58	<b>MESSE A BESSONG John Jr</b>	2	4	BELAL Rayan	10 - 0	0:00	FUS
B-63	POULIN-LABELLE Maxime	1	3	<b>BLANEY Andrew</b>	0 - 10	0:00	FUS
A-1	MESSE A BESSONG John Jr	2	5	DESCHENES Marc	0 - 10	1:41	IPO

## Results/Résultats

Pos	Name/Nom
1	DESCHENES Marc, QC
2	MESSE A BESSONG John Jr, QC
3	BLANEY Andrew, NB
4	BELAL Rayan, QC