

# Seniors Female -48kg

## Competitors/Compétiteurs A

#	Name/Nom	Grade	Club	1	2	3	W/G	Pts	Pos
1	Angelina MCCRISTALL	Shodan	Upper Canada	XX			0	0	3
2	Heidi QUACH	Shodan	Métropolitain	10	XX	5	2	15	1
3	Marie-Lune TURMEL	Shodan	Blainville	10		XX	1	10	2

## Pool A

Match	White/Blanc			Blue/Bleu	Res/Rés	Tim/Tmp	Code
A-50	Angelina MCCRISTALL	1	2	Heidi QUACH	0 - 10	0:55	WIP
A-57	Angelina MCCRISTALL	1	3	Marie-Lune TURMEL	0 - 10	1:48	IPO
A-63	Heidi QUACH	2	3	Marie-Lune TURMEL	5 - 0	4:12	GSW

## Competitors/Compétiteurs B

#	Name/Nom	Grade	Club	4	5	6	W/G	Pts	Pos
4	Valeria KOSTROVETS	Brown	Métropolitain	XX			0	0	3
5	Addyson TAMURA	Brown	Lethbridge	10	XX		1	10	2
6	Charlize Isabelle MEDILO	Shodan	Shidokan	10	10	XX	2	20	1

## Pool B

Match	White/Blanc			Blue/Bleu	Res/Rés	Tim/Tmp	Code
A-51	Valeria KOSTROVETS	4	5	Addyson TAMURA	0 - 10	2:12	DHM/HMD
A-58	Valeria KOSTROVETS	4	6	Charlize Isabelle MEDILO	0 - 10	0:00	DHM/HMD
A-64	Addyson TAMURA	5	6	Charlize Isabelle MEDILO	0 - 10	1:42	IPO

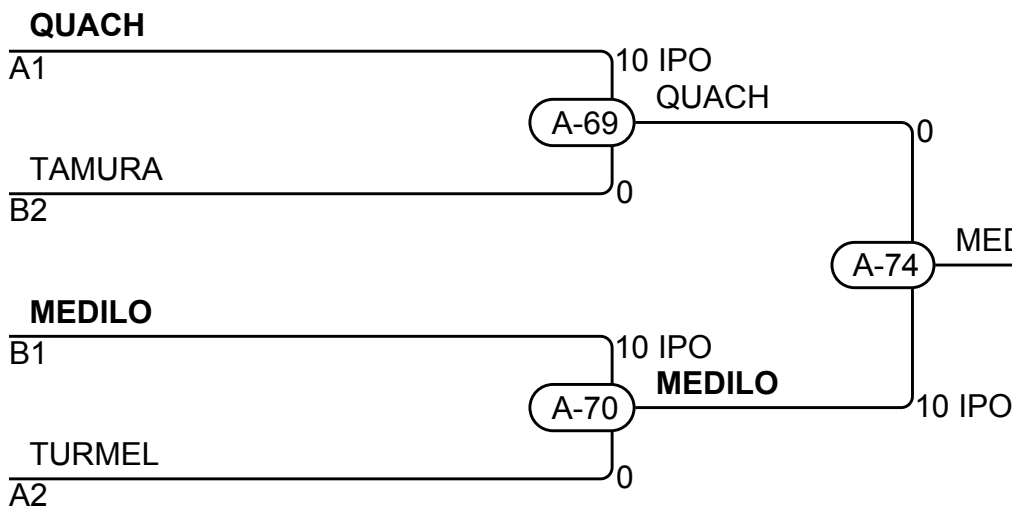

## Results/Résultats

Pos	Name/Nom
1	Charlize Isabelle MEDILO, Shidokan
2	Heidi QUACH, Métropolitain
3	Addyson TAMURA, Lethbridge
3	Marie-Lune TURMEL, Blainville

# Seniors Female -52kg

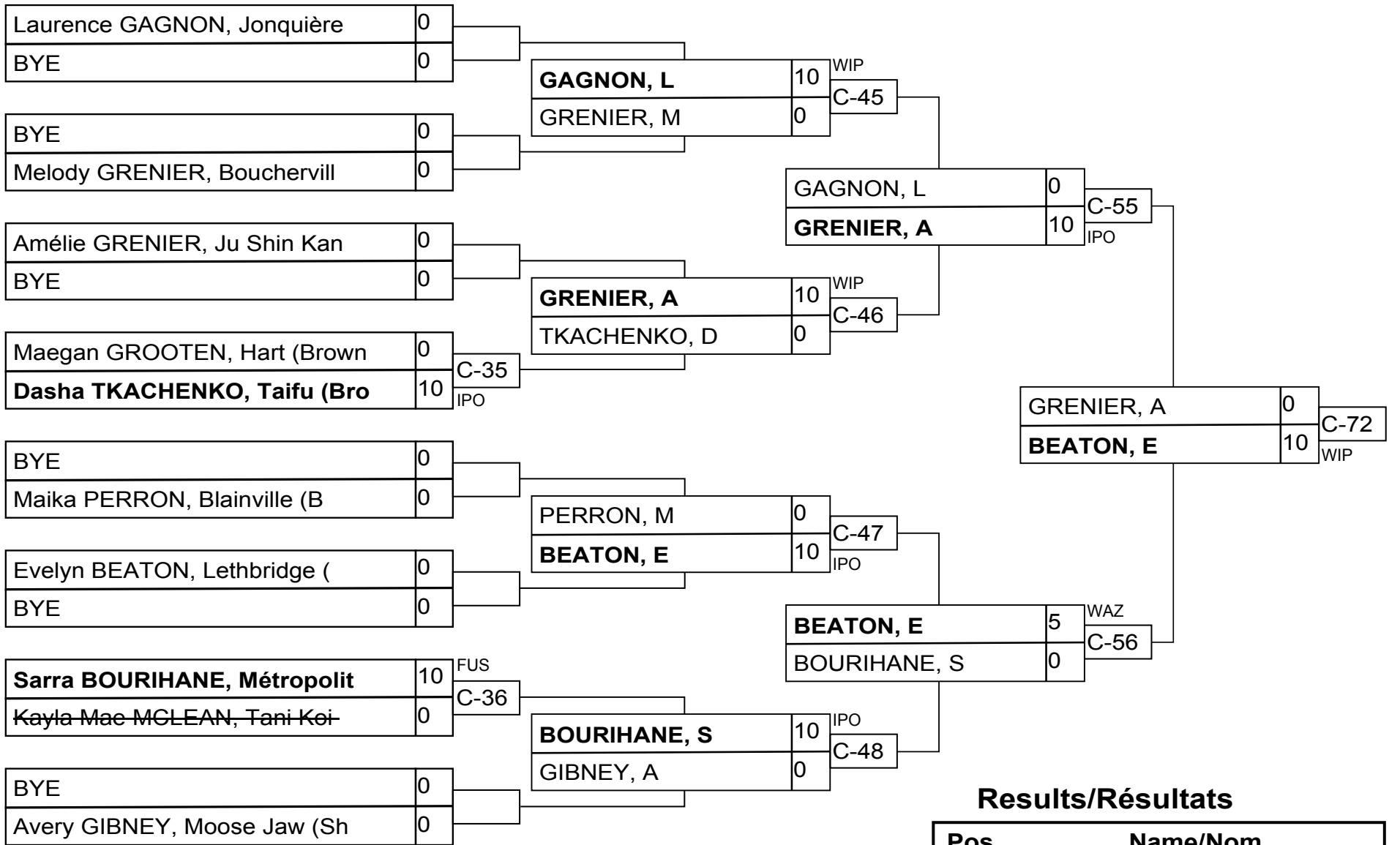

## Results/Résultats

Pos	Name/Nom
1	Evelyn BEATON, Lethbridg
2	Amélie GRENIER, Ju Shin
3	Laurence GAGNON, Jonquiè
3	Sarra BOURIHANE, Métropo

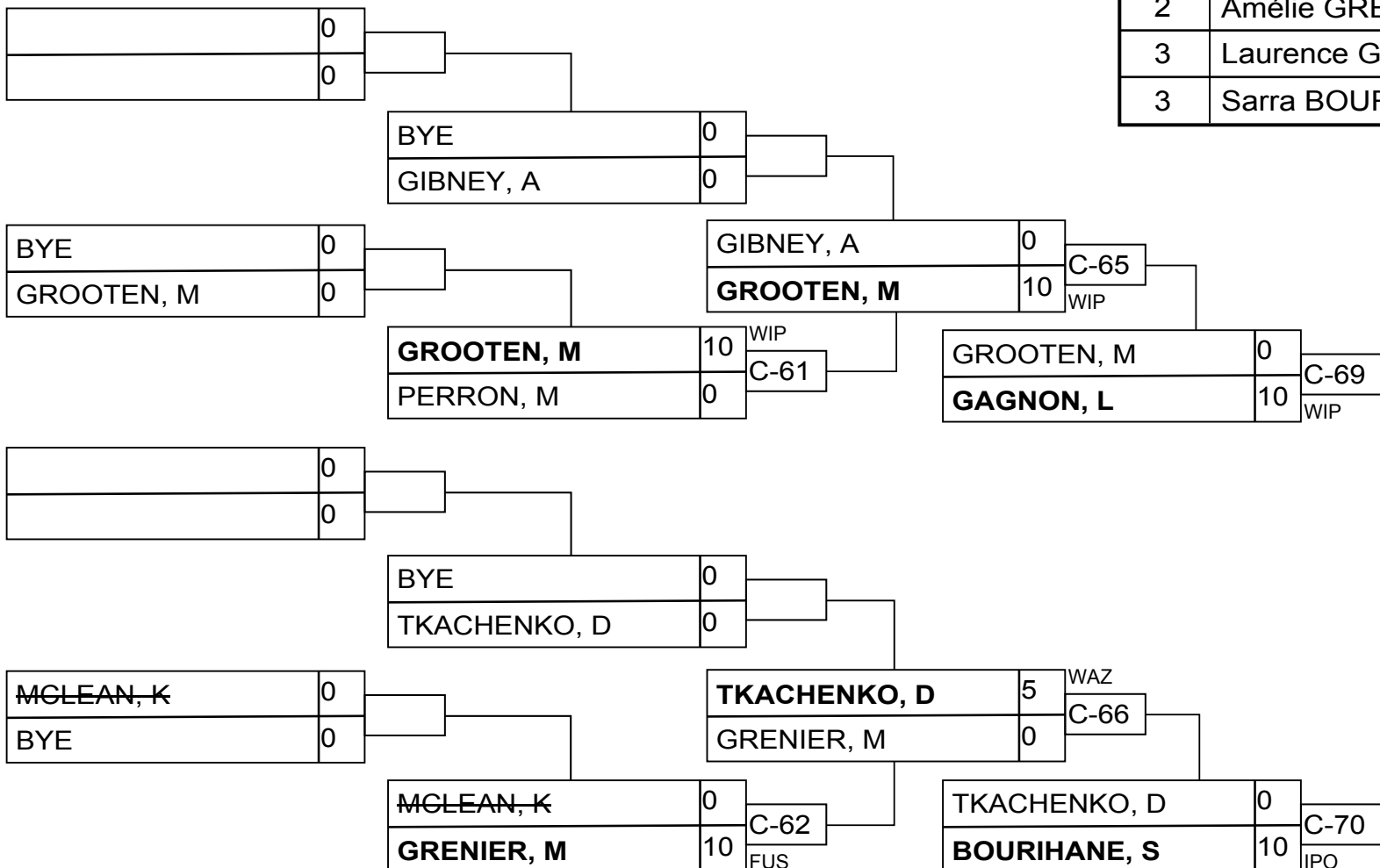

# Seniors Female -57kg

<b>Inara BARDAI, Tritton (Brow)</b>	10	IPO			
Dilana GESA, Shin Bu Kan (O)	0	E-13			
<b>BARDAI, I</b>	10	IPO			
KARAS, K	0	E-30			
<b>Kondelia KARAS, Kodokwai (N)</b>	10	IPO			
Maya KUNADZE, Kokushikai (S)	0	E-15			
<b>BARDAI, I</b>	10	WIP			
LOUET, V	0	E-51			
<b>Violette LOUET, Judo Monde</b>	10	IPO			
Gwen WHITTLE, Campbell Rive	0	E-16			
<b>LOUET, V</b>	10	WIP			
TEPER, S	0	E-31			
Kolbi FENRICK, Moose Jaw (S)	0	E-17			
<b>Sofia TEPER, Hayabusakan (B)</b>	5	GSW			
<b>BARDAI, I</b>	10	IPO			
VAN ZYL, C	0	E-80			
<b>Carla VAN ZYL, Hart (Shodan)</b>	10	IPO			
Leah MICHAUD, Judo Beauce (	0	E-18			
<b>VAN ZYL, C</b>	10	IPO			
IRVING, R	0	E-32			
Rayne IRVING, Asahi (Brown)	0				
BYE	0				
<b>VAN ZYL, C</b>	10	IPO			
THIBEAULT, H	0	E-52			
Alyssandra Phoebe MANUEL, S	0	E-19			
<b>Hayden THIBEAULT, Otoshi Di</b>	5	WAZ			
<b>THIBEAULT, H</b>	10	IPO			
WONG, J	0	E-33			
<b>Juniper WONG, Action &amp; Reac</b>	10	WIP			
Nevada JONES, Prince George	0	E-20			

## Results/Résultats

Pos	Name/Nom
1	Inara BARDAI, Tritton (B
2	Carla VAN ZYL, Hart (Sho
3	Violette LOUET, Judo Mon
3	Hayden THIBEAULT, Otoshi

<b>GESA, D</b>	10	IPO			
KUNADZE, M	0	E-42			
<b>GESA, D</b>	0				
<b>WONG, J</b>	10	E-59			
		HAN			
<b>WONG, J</b>	5	WAZ			
FENRICK, K	0	E-69			
WHITTLE, G	0	E-43			
<b>FENRICK, K</b>	10	IPO			
<b>FENRICK, K</b>	10	IPO			
IRVING, R	0	E-60			
<b>WONG, J</b>	0				
<b>LOUET, V</b>	5	E-75			
		WAZ			
MICHAUD, L	0				
BYE	0				
<b>MICHAUD, L</b>	10	IPO			
TEPER, S	0	E-61			
<b>MANUEL, A</b>	10	IPO			
JONES, N	0	E-44			
<b>MICHAUD, L</b>	0				
<b>MANUEL, A</b>	10	IPO			
<b>MANUEL, A</b>	5	GSW			
KARAS, K	0	E-62			
<b>MANUEL, A</b>	0				
<b>THIBEAULT, H</b>	5	E-76			
		GSW			

# Seniors Female -63kg

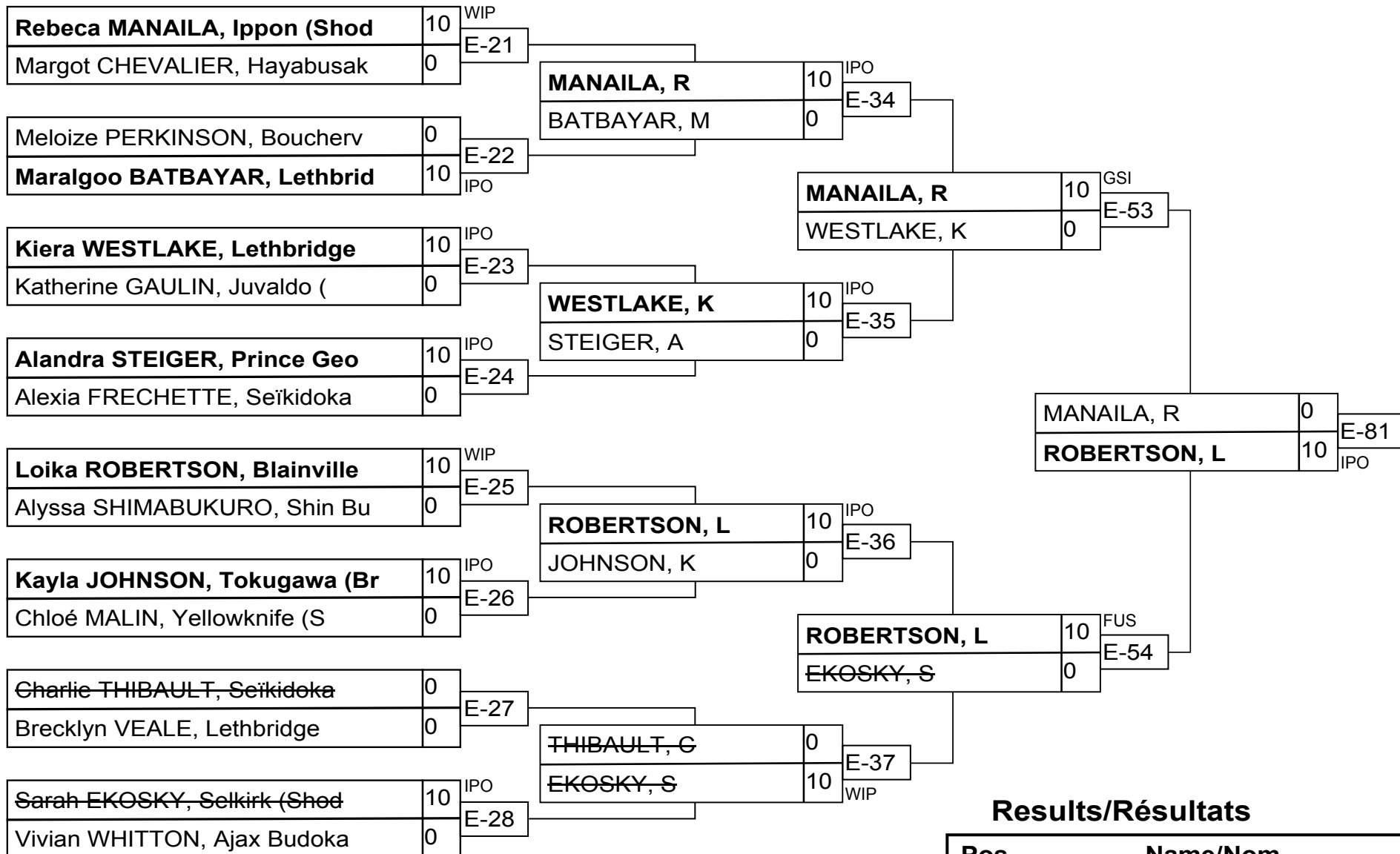

## Results/Résultats

Pos	Name/Nom
1	Loika ROBERTSON, Blainvi
2	Rebeca MANAILA, Ippon (S
3	Kiera WESTLAKE, Lethbrid
3	Alandra STEIGER, Prince

CHEVALIER, M	10	IPO
PERKINSON, M	0	E-45

CHEVALIER, M	10	DHM/HMD
THIBAUT, G	0	E-63

GAULIN, K	10	FUS
FRECHETTE, A	0	E-46

CHEVALIER, M	10	IPO
JOHNSON, K	0	E-71

GAULIN, K	0	E-64
JOHNSON, K	10	IPO

CHEVALIER, M	0	E-77
WESTLAKE, K	10	WIP

SHIMABUKURO, A	0	E-47
MALIN, C	10	WIP

MALIN, C	0	E-65
STEIGER, A	10	IPO

VEALE, B	0	E-48
WHITTON, V	10	IPO

STEIGER, A	10	IPO
BATBAYAR, M	0	E-72

WHITTON, V	0	E-66
BATBAYAR, M	10	HAN

STEIGER, A	10	FUS
EKOSKY, S	0	E-78

# Seniors Female -78kg

## Competitors/Compétiteurs

#	Name/Nom	Grade	Club	1	2	3	4	W/G	Pts	Pos
1	Zen MINEQUE	Brown	Trent Univ Judo Club	XX	10			1	10	3
2	Kathleen CHONG	Brown	Trent Univ Judo Club		XX			0	0	4
3	Naomi FOWLER	Brown	Tani Koi	5	5	XX		2	10	2
4	Melissa MYERS	Nidan	Jason Morris Judo Centre	10	10	10	XX	3	30	1

## Matches/Matches

Match	White/Blanc			Blue/Bleu	Res/Rés	Tim/Tmp	Code
A-71A	Zen MINEQUE	1	2	Kathleen CHONG	10 - 0	0:18	IPO
A-54	Naomi FOWLER	3	4	Melissa MYERS	0 - 10	2:29	IPO
A-75	Zen MINEQUE	1	3	Naomi FOWLER	0 - 5	0:09	WAZ
A-62	Kathleen CHONG	2	4	Melissa MYERS	0 - 10	0:14	IPO
A-67	Zen MINEQUE	1	4	Melissa MYERS	0 - 10	1:15	IPO
A-73A	Kathleen CHONG	2	3	Naomi FOWLER	0 - 5	1:44	WAZ

## Results/Résultats

Pos	Name/Nom
1	Melissa MYERS, Jason Morris Judo Centre
2	Naomi FOWLER, Tani Koi
3	Zen MINEQUE, Trent Univ Judo Club

# Seniors Female -78kg (TB)

## Competitors/Compétiteurs

#	Name/Nom	Grade	Club	1	2	3	W/G	Pts	Pos
1	Kathleen CHONG	Brown	Trent Univ Judo Club	XX			0	0	3
2	Zen MINEQUE	Brown	Trent Univ Judo Club	10	XX		1	10	2
3	Naomi FOWLER	Brown	Tani Koi	5	5	XX	2	10	1

## Matches/Matches

Match	White/Blanc			Blue/Bleu	Res/Rés	Tim/Tmp	Code
A-71A	Kathleen CHONG	1	2	Zen MINEQUE	0 - 10	0:18	IPO
A-73A	Kathleen CHONG	1	3	Naomi FOWLER	0 - 5	1:44	WAZ
A-75	Zen MINEQUE	2	3	Naomi FOWLER	0 - 5	0:09	WAZ

## Results/Résultats

Pos	Name/Nom
1	Naomi FOWLER, Tani Koi
2	Zen MINEQUE, Trent Univ Judo Club

# Seniors Female +78kg

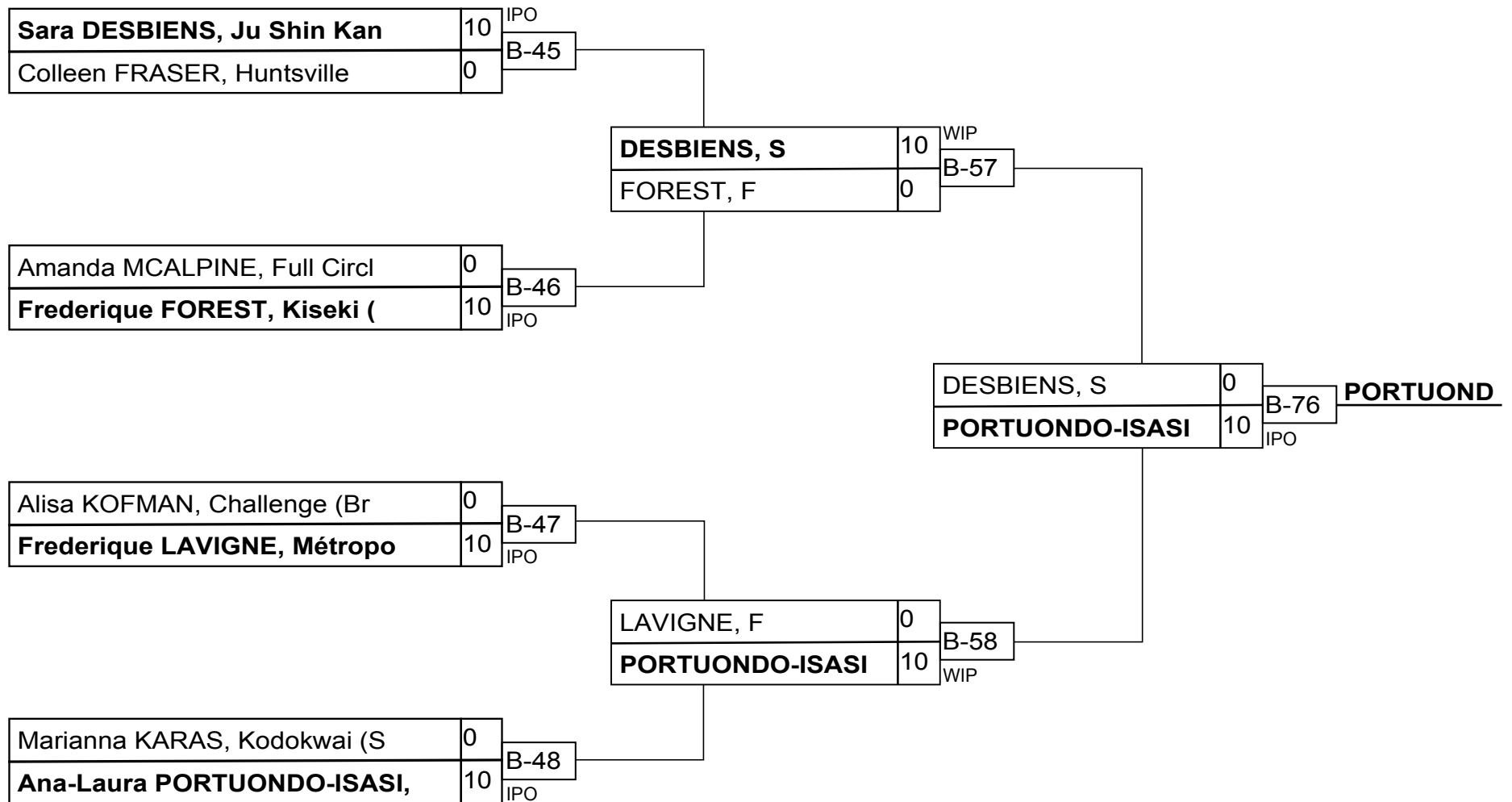

## Results/Résultats

Pos	Name/Nom
1	Ana-Laura PORTUONDO-ISAS
2	Sara DESBIENS, Ju Shin K
3	Marianna KARAS, Kodokwai
3	Frederique LAVIGNE, Métr

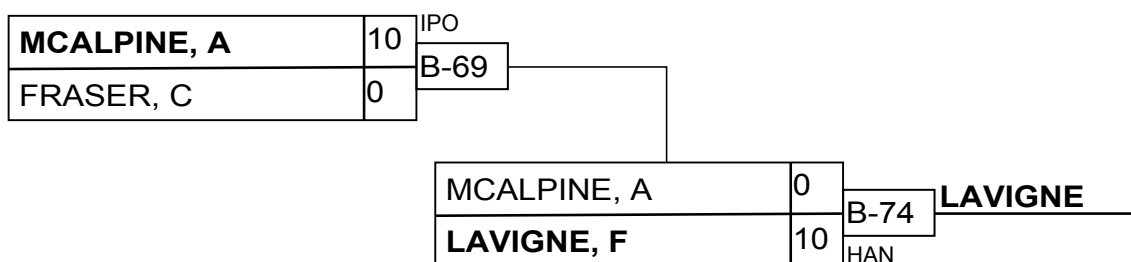
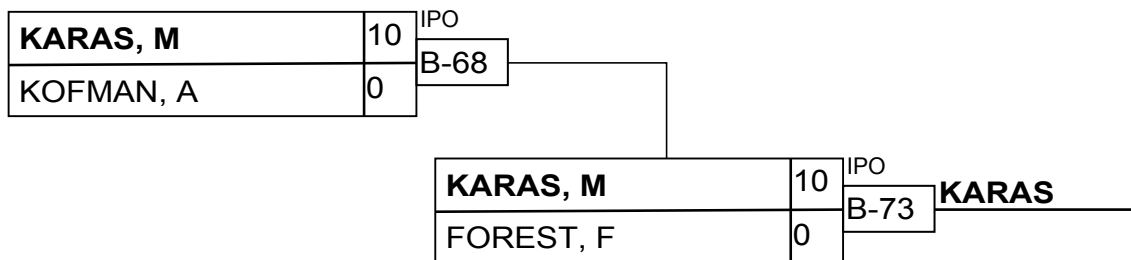

# Seniors Male -100kg

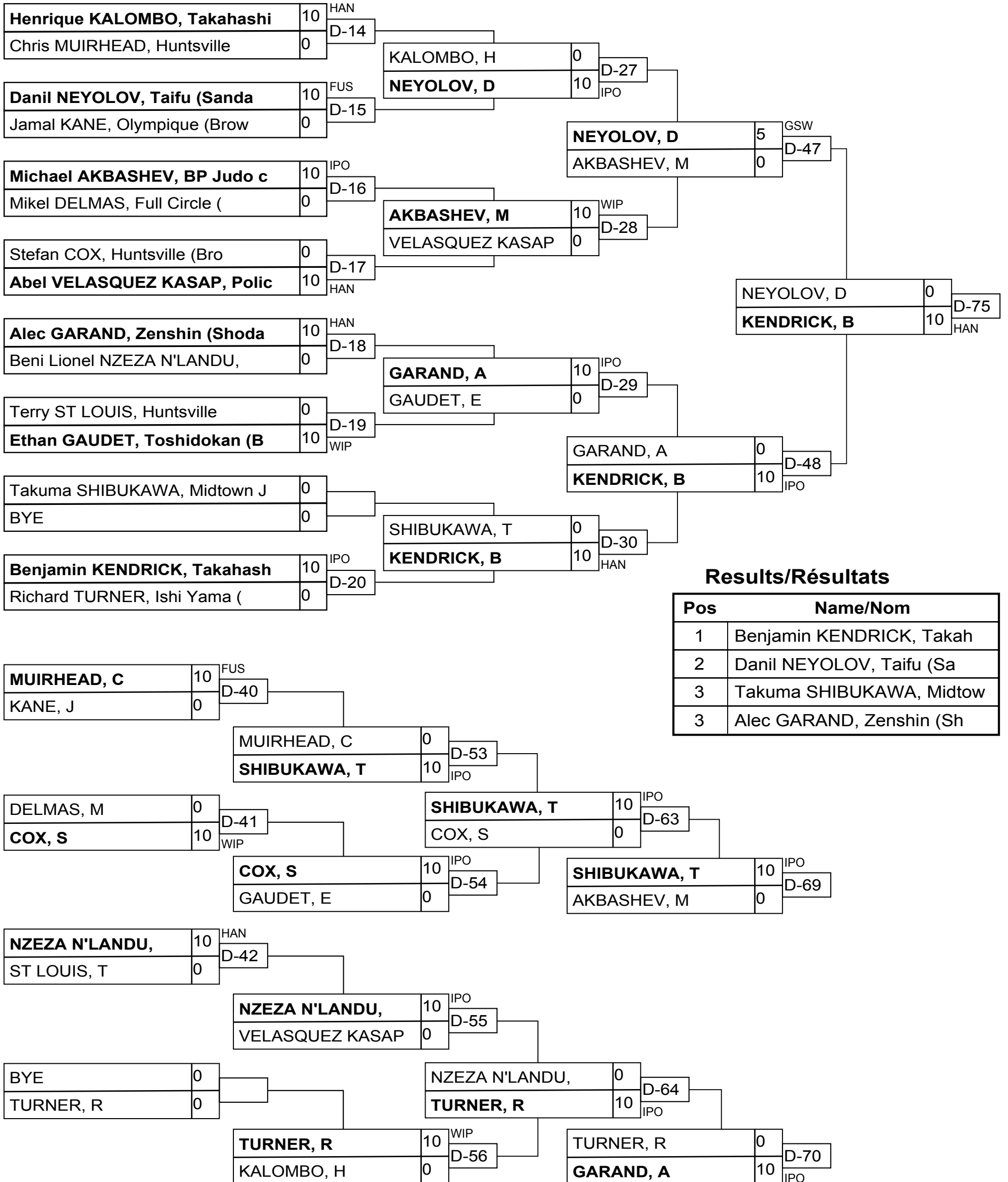

## Results/Résultats

Pos	Name/Nom
1	Benjamin KENDRICK, Takah
2	Danil NEYOLOV, Taifu (Sa
3	Takuma SHIBUKAWA, Midtow
3	Alec GARAND, Zenshin (Sh



# Seniors Male -60kg

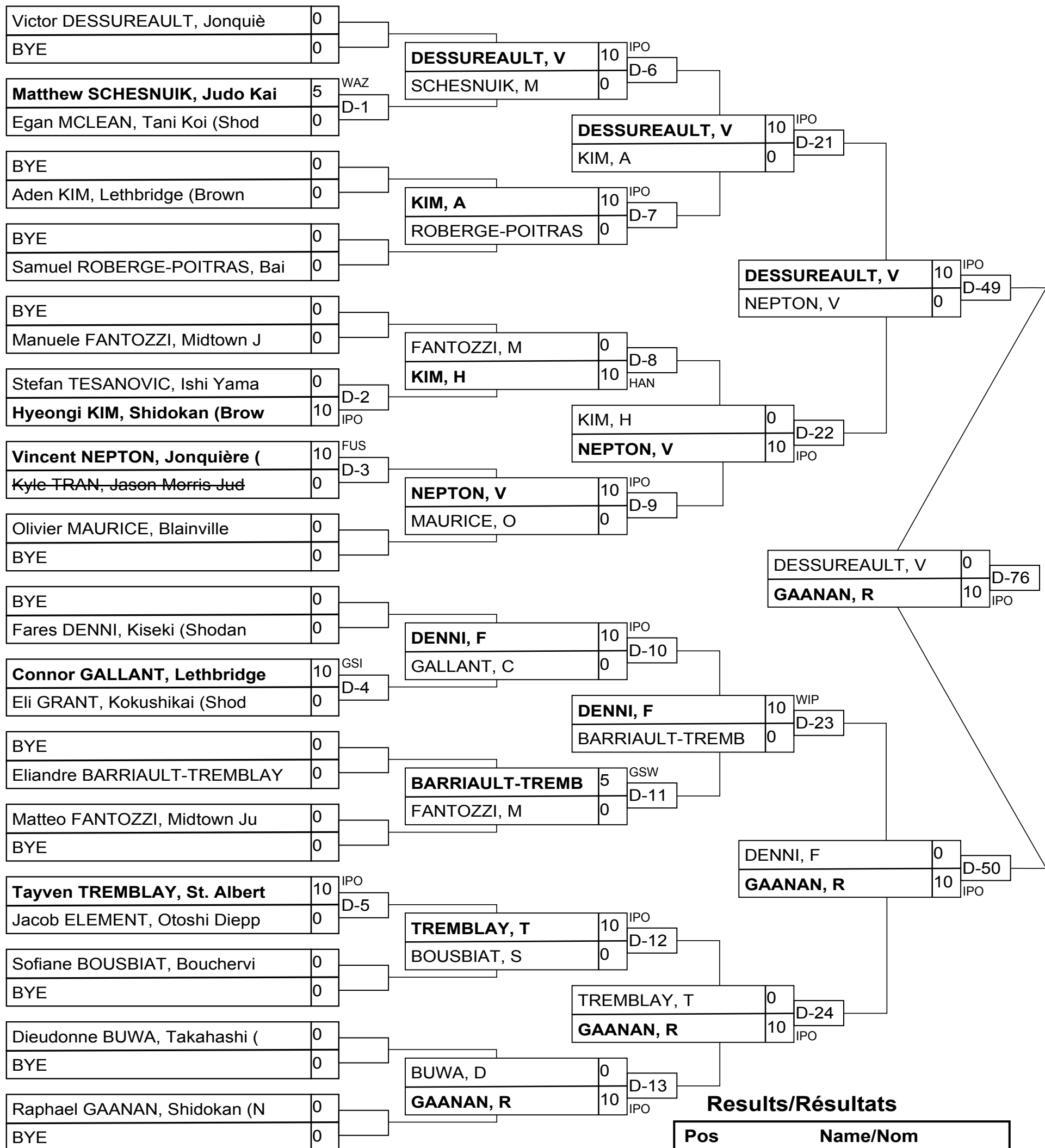

## Results/Résultats

Pos	Name/Nom
1	Raphael GAANAN, Shidokan
2	Victor DESSUREAULT, Jonq
3	Vincent NEPTON, Jonquièr
3	Matteo FANTOZZI, Midtown

# Seniors Male -60kg

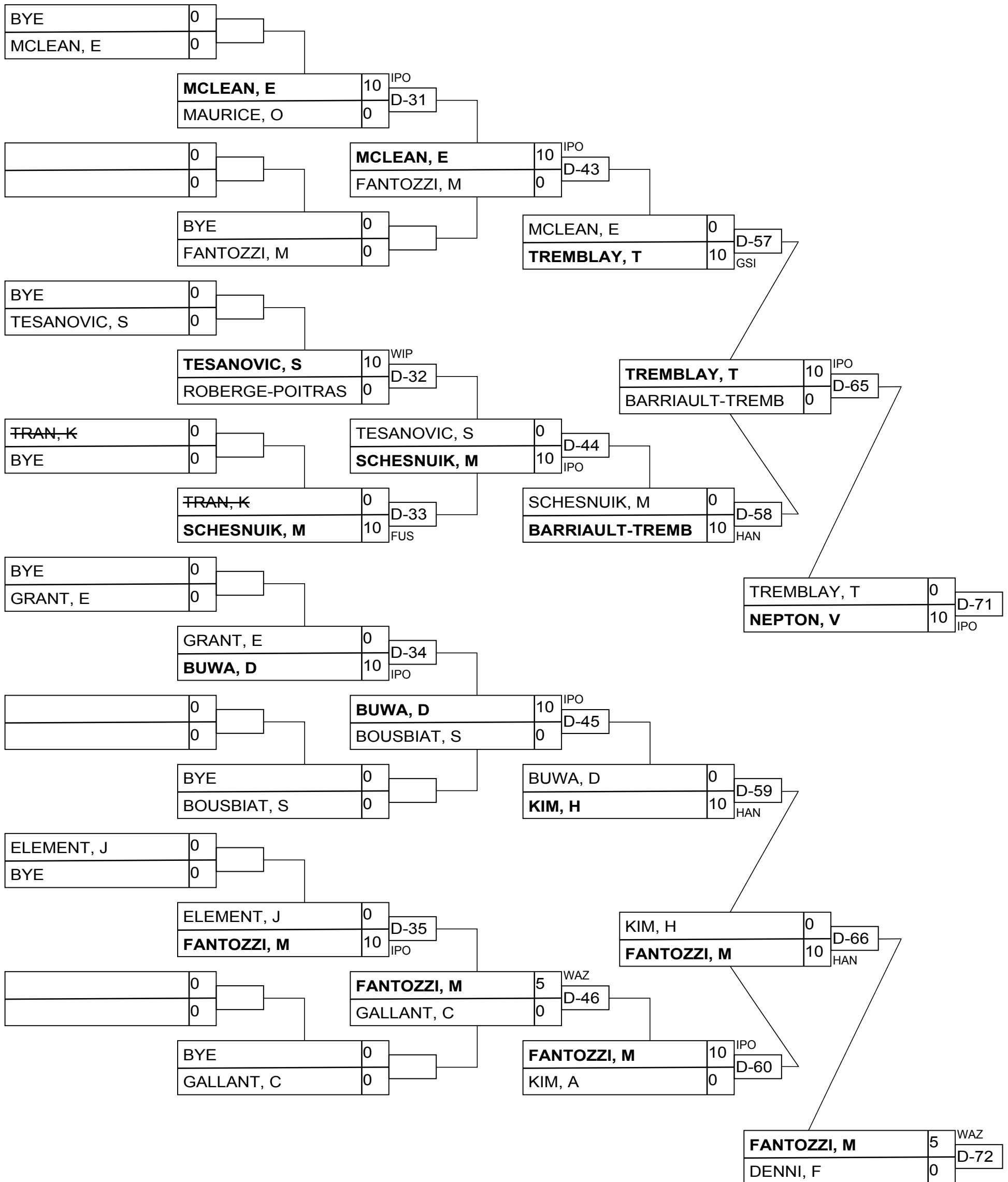

# Seniors Male -66kg

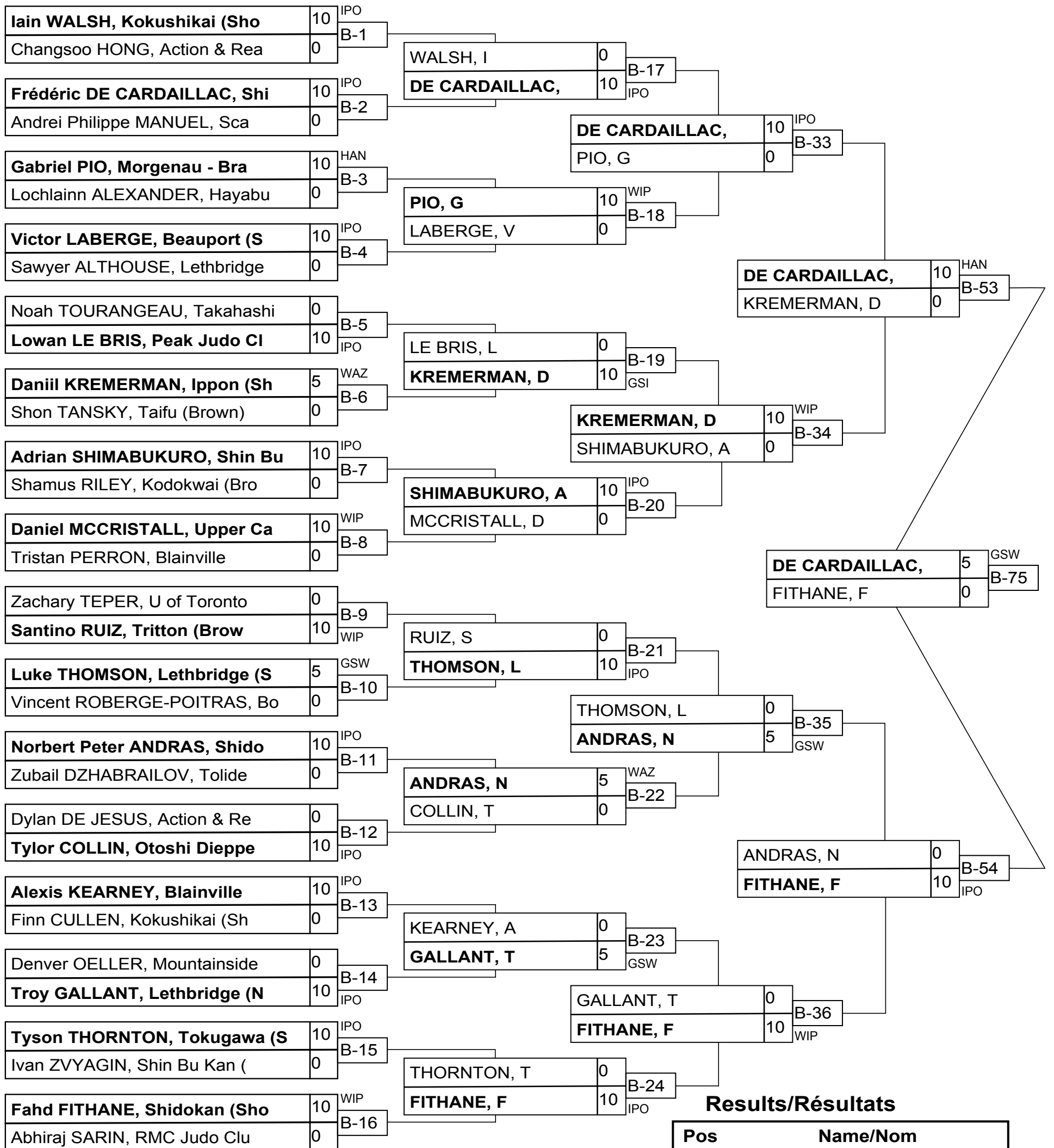

## Results/Résultats

Pos	Name/Nom
1	Frédéric DE CARDAILLAC,
2	Fahd FITHANE, Shidokan (
3	Daniil KREMERMANN, Ippon
3	Gabriel PIO, Morgenau -

# Seniors Male -66kg

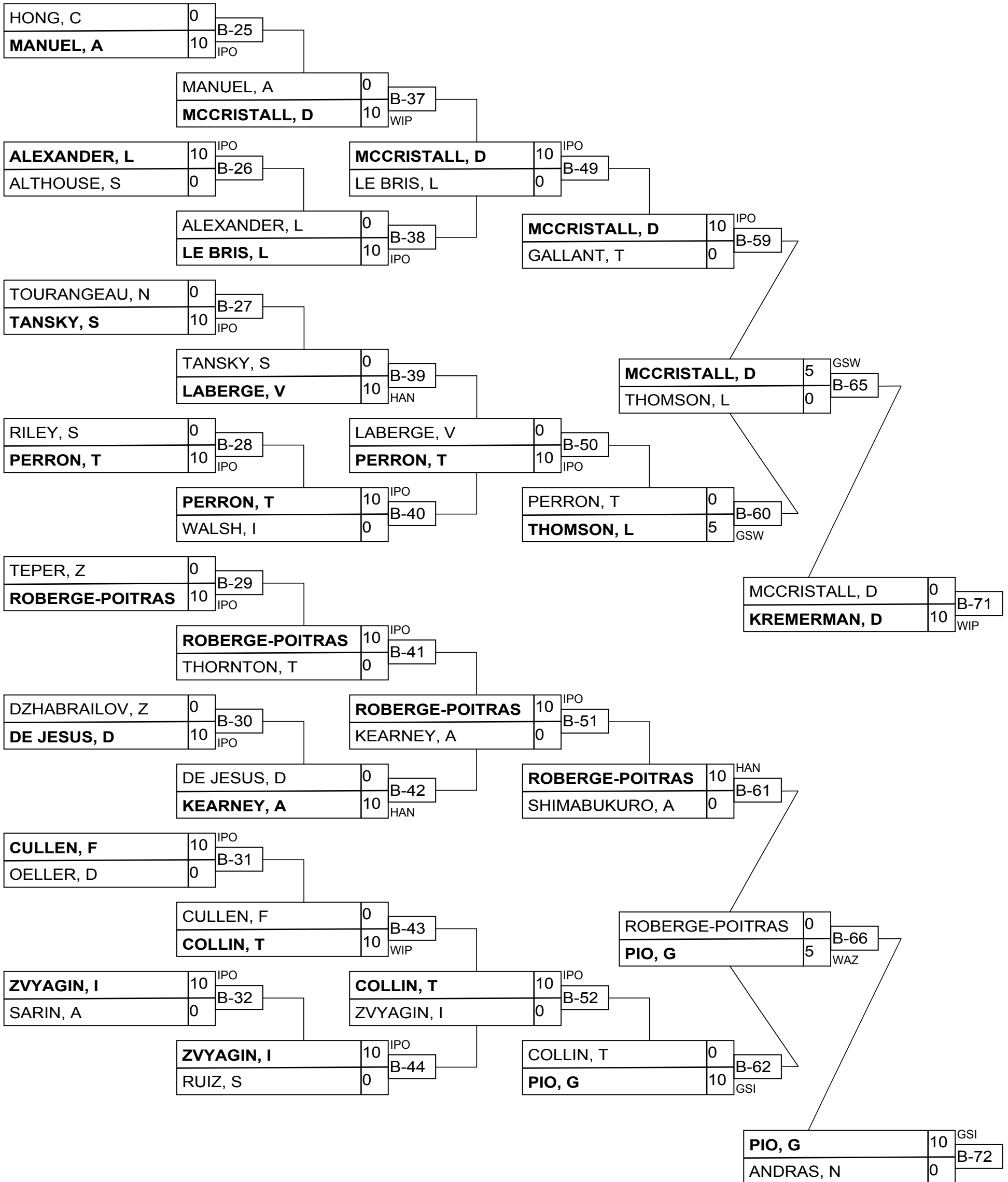

# Seniors Male -73kg

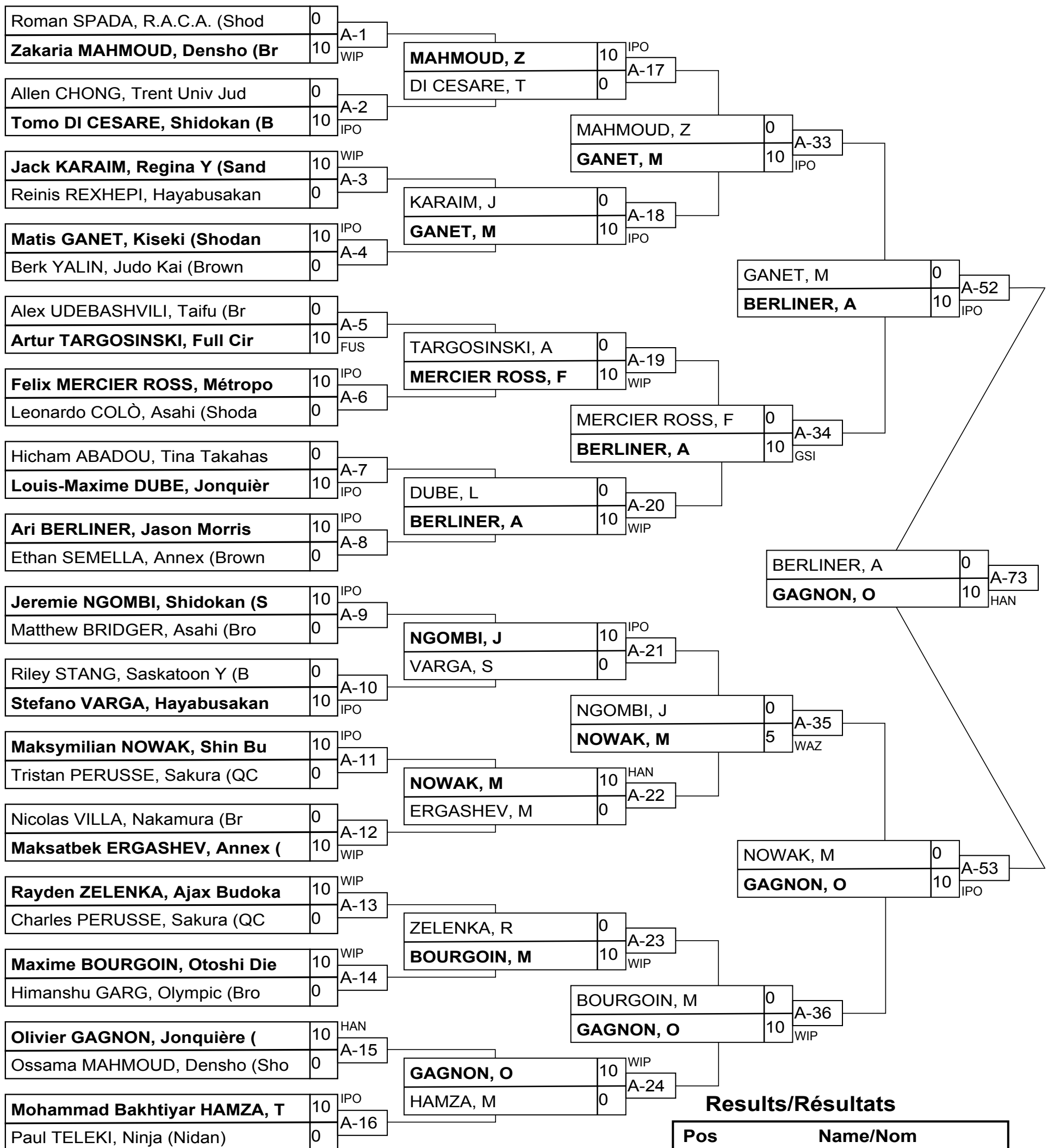

## Results/Résultats

Pos	Name/Nom
1	Olivier GAGNON, Jonquièr
2	Ari BERLINER, Jason Morr
3	Matis GANET, Kiseki (Sho)
3	Felix MERCIER ROSS, Métr

# Seniors Male -73kg

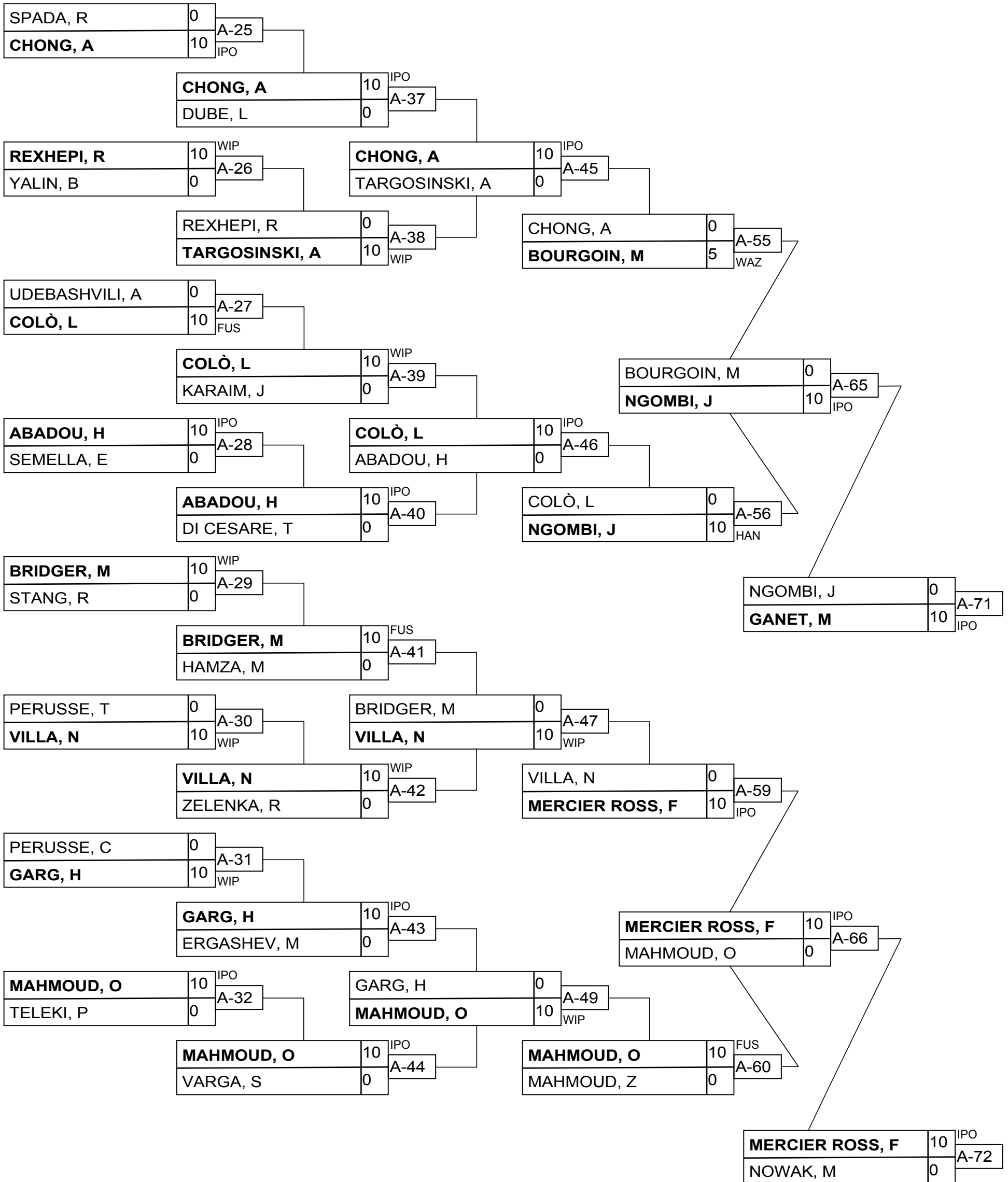

# Seniors Male -81kg

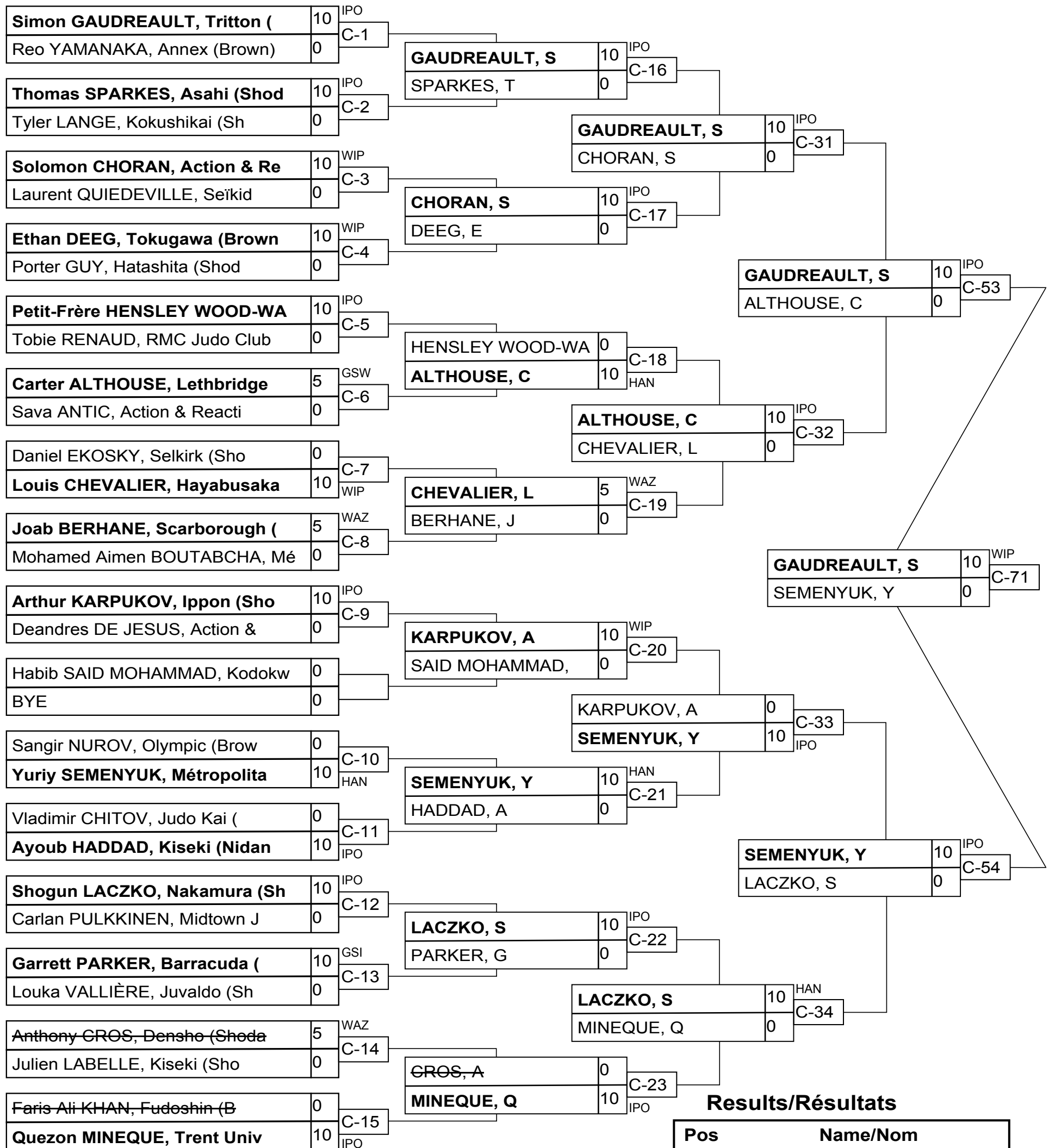

## Results/Résultats

Pos	Name/Nom
1	Simon GAUDREULT, Tritto
2	Yuriy SEMENYUK, Métropol
3	Arthur KARPUKOV, Ippon (
3	Solomon CHORAN, Action &

# Seniors Male -81kg

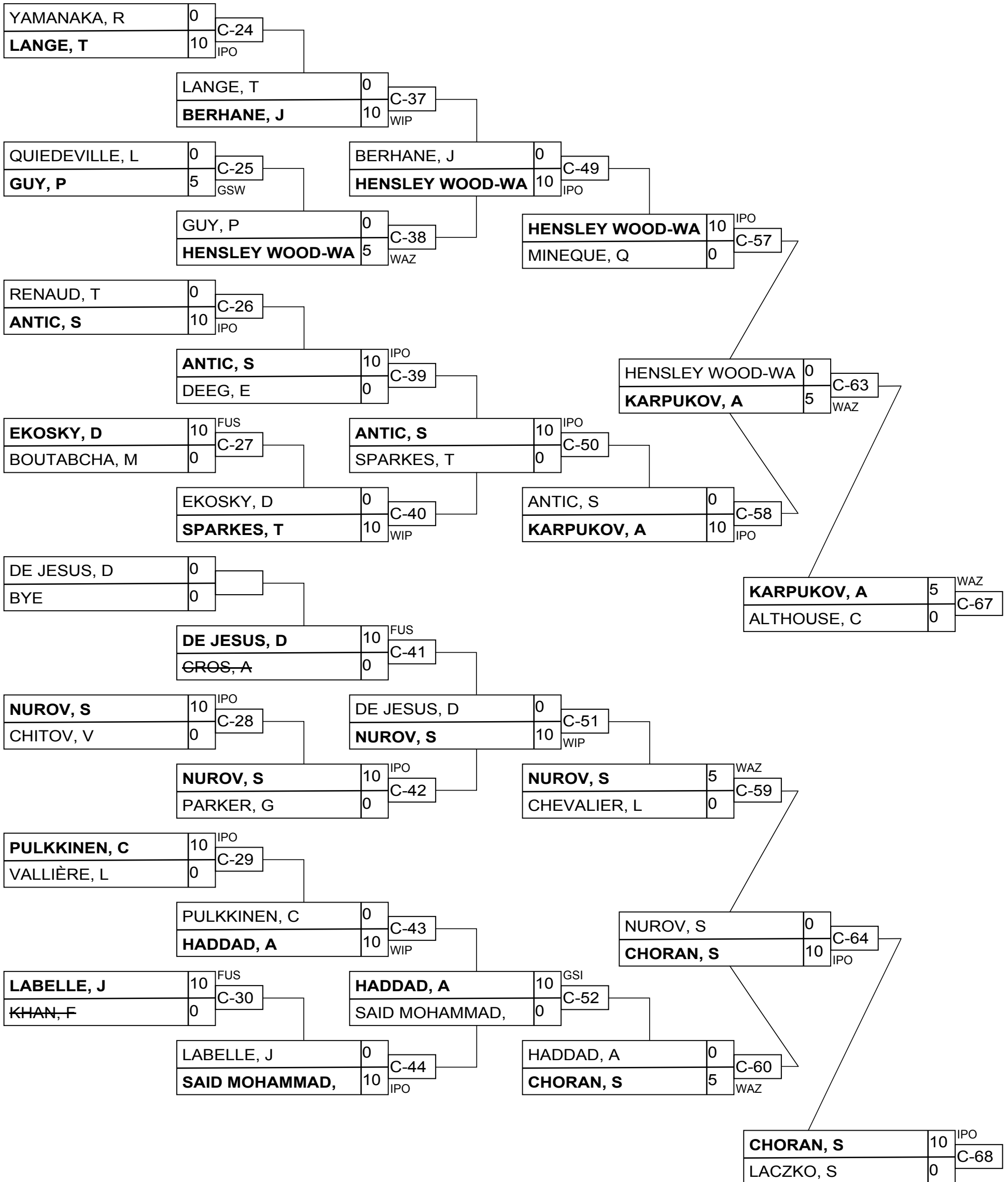



# Seniors Male -90kg

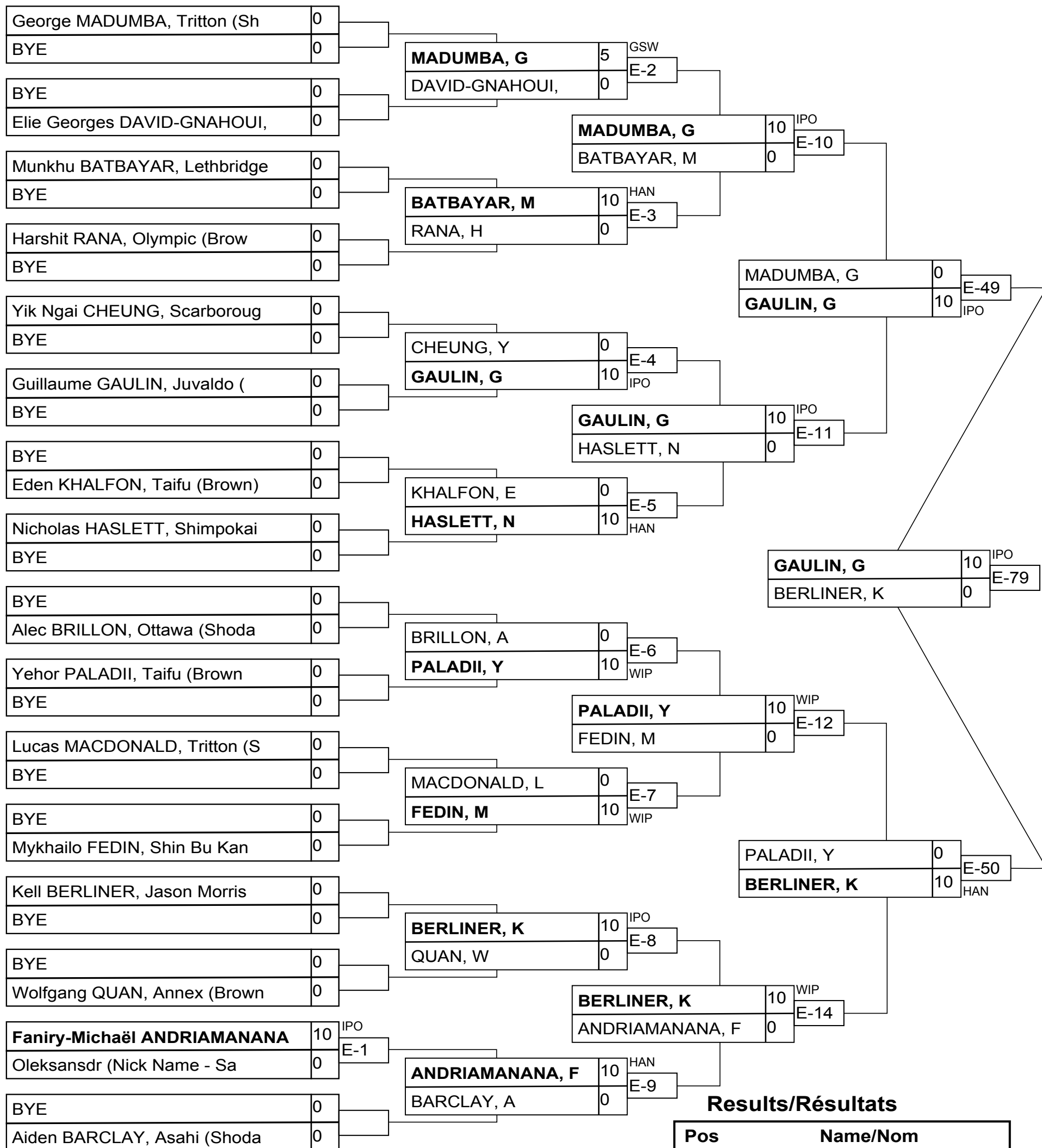

## Results/Résultats

Pos	Name/Nom
1	Guillaume GAULIN, Juvaldo
2	Kell BERLINER, Jason Mor
3	Faniry-Michaël ANDRIAMAN
3	Aiden BARCLAY, Asahi (Sh

# Seniors Male -90kg

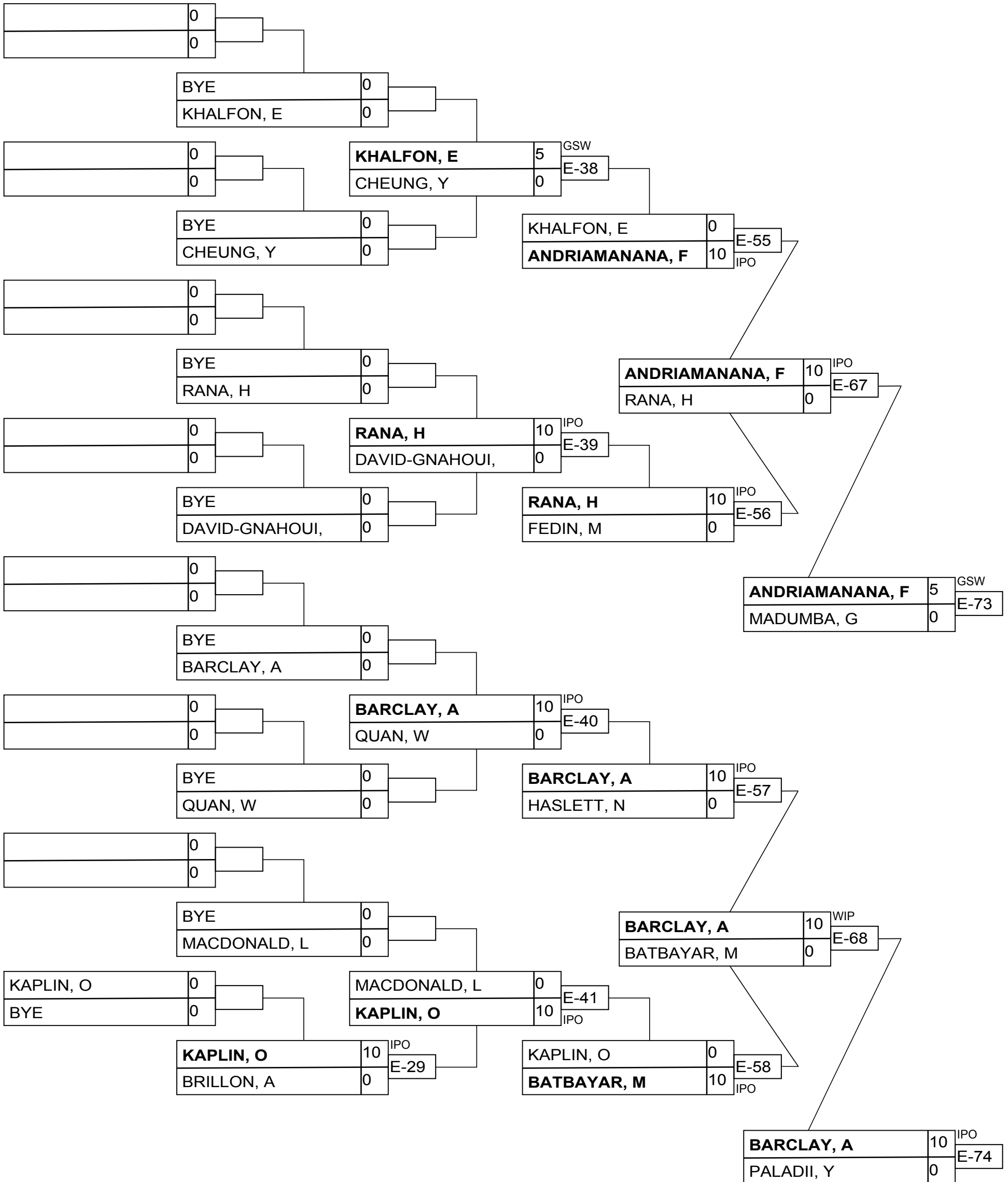

# Seniors Male +100kg

## Competitors/Compétiteurs

#	Name/Nom	Grade	Club	1	2	3	4	W/G	Pts	Pos
1	Lucas ALLEN	Brown	Huntsville	XX	10			1	10	3
2	Sébastien GODIN	Nidan	Uplands Judo Club		XX			0	0	4
3	Jeff ALLEN	Shodan	Huntsville	10	10	XX		2	20	2
4	Martin RYGIELSKI	Shodan	Asahi	10	10	10	XX	3	30	1

## Matches/Matches

Match	White/Blanc			Blue/Bleu	Res/Rés	Tim/Tmp	Code
B-55	Lucas ALLEN	1	2	Sébastien GODIN	10 - 0	1:20	IPO
B-56	Jeff ALLEN	3	4	Martin RYGIELSKI	0 - 10	0:53	IPO
B-63	Lucas ALLEN	1	3	Jeff ALLEN	0 - 10	0:27	IPO
B-64	Sébastien GODIN	2	4	Martin RYGIELSKI	0 - 10	0:00	FUS
B-67	Lucas ALLEN	1	4	Martin RYGIELSKI	0 - 10	0:30	IPO
B-70	Sébastien GODIN	2	3	Jeff ALLEN	0 - 10	0:00	FUS

## Results/Résultats

Pos	Name/Nom
1	Martin RYGIELSKI, Asahi
2	Jeff ALLEN, Huntsville
3	Lucas ALLEN, Huntsville

# Seniors Female Open Weight

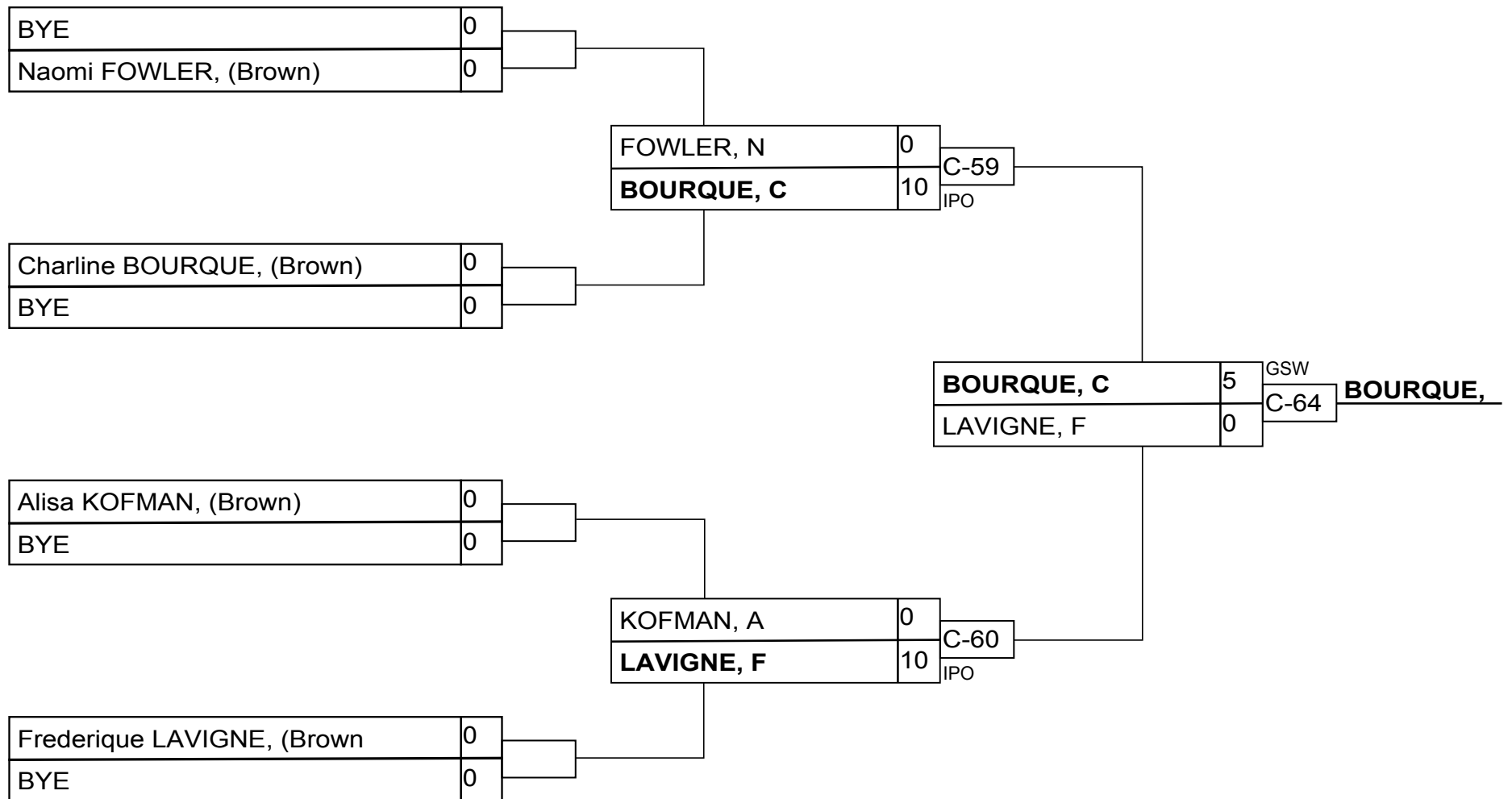

## Results/Résultats

Pos	Name/Nom
1	Charline BOURQUE, (Brow
2	Frederique LAVIGNE, (Br
3	Naomi FOWLER, (Brown)
3	Alisa KOFMAN, (Brown)

# Seniors Int Female Light

## Competitors/Compétiteurs

#	Name/Nom	Grade	Club	1	2	3	4	W/G	Pts	Pos
1	Elizabeth SANIKIDZE	Blue	Tokugawa	XX		10	10	2	20	2
2	Braelyn THOMPSON	Blue	Kodokwai	10	XX	10	10	3	30	1
3	Chloe FAHIE	Green	Numa			XX	10	1	10	3
4	Albina ROBINSON	Green	Huntsville				XX	0	0	4

## Matches/Matches

Match	White/Blanc			Blue/Bleu	Res/Rés	Tim/Tmp	Code
D-26	Elizabeth SANIKIDZE	1	2	<b>Braelyn THOMPSON</b>	0 - 10	3:45	WIP
D-27	<b>Chloe FAHIE</b>	3	4	Albina ROBINSON	10 - 0	0:46	WIP
D-35	<b>Elizabeth SANIKIDZE</b>	1	3	Chloe FAHIE	10 - 0	0:46	IPO
D-36	<b>Braelyn THOMPSON</b>	2	4	Albina ROBINSON	10 - 0	0:31	WIP
D-45	<b>Elizabeth SANIKIDZE</b>	1	4	Albina ROBINSON	10 - 0	0:55	IPO
D-46	<b>Braelyn THOMPSON</b>	2	3	Chloe FAHIE	10 - 0	0:28	IPO

## Results/Résultats

Pos	Name/Nom
1	Braelyn THOMPSON, Kodokwai
2	Elizabeth SANIKIDZE, Tokugawa
3	Chloe FAHIE, Numa

# Seniors Int Female Middle

## Competitors/Compétiteurs

#	Name/Nom	Grade	Club	1	2	3	4	W/G	Pts	Pos
1	Charelle KAMY	Blue	RMC Judo Club	XX	10	10	10	3	30	1
2	Katille DOUGLAS	Green	Huntsville		XX	10		1	10	2
3	Myroslava BONDARENKO	Blue	Shidokan			XX	10	1	10	3
4	Katherine BROWN	Green	Numa		5		XX	1	5	4

## Matches/Matches

Match	White/Blanc			Blue/Bleu	Res/Rés	Tim/Tmp	Code
A-31	<b>Charelle KAMY</b>	1	2	Katille DOUGLAS	10 - 0	1:23	IPO
A-32	<b>Myroslava BONDARENKO</b>	3	4	Katherine BROWN	10 - 0	0:56	WIP
A-41	<b>Charelle KAMY</b>	1	3	Myroslava BONDARENKO	10 - 0	1:50	IPO
A-42	Katille DOUGLAS	2	4	<b>Katherine BROWN</b>	0 - 5	4:00	WAZ
A-48	<b>Charelle KAMY</b>	1	4	Katherine BROWN	10 - 0	3:22	IPO
A-49	<b>Katille DOUGLAS</b>	2	3	Myroslava BONDARENKO	10 - 0	1:52	IPO

## Results/Résultats

Pos	Name/Nom
1	Charelle KAMY, RMC Judo Club
2	Katille DOUGLAS, Huntsville
3	Myroslava BONDARENKO, Shidokan
4	Katherine BROWN, Numa

# Seniors Int Male -100kg

## Competitors/Compétiteurs

#	Name/Nom	Grade	Club	1	2	3	4	5	W/G	Pts	Pos
1	Nikolay CHUKALOVSKIY	Blue	IPÊ DOJO	XX	10	10	10	10	4	40	1
2	Satvik SOOD	Green	RMC Judo Club		XX				0	0	5
3	Cai JAMES	Blue	Balmoral		10	XX	10	10	3	30	2
4	Ian VAN STYGEREN	Green	Huntsville		10		XX	10	2	20	3
5	Josh JONES	Green	Huntsville		10			XX	1	10	4

## Matches/Matches

Match	White/Blanc			Blue/Bleu	Res/Rés	Tim/Tmp	Code
E-3	Ian VAN STYGEREN	4	5	Josh JONES	10 - 0	1:12	IPO
E-4	Nikolay CHUKALOVSKIY	1	2	Satvik SOOD	10 - 0	0:50	WIP
E-10	Cai JAMES	3	4	Ian VAN STYGEREN	10 - 0	1:34	IPO
E-11	Nikolay CHUKALOVSKIY	1	5	Josh JONES	10 - 0	2:08	IPO
E-21	Satvik SOOD	2	3	Cai JAMES	0 - 10	0:10	IPO
E-22	Nikolay CHUKALOVSKIY	1	4	Ian VAN STYGEREN	10 - 0	3:20	IPO
E-33	Cai JAMES	3	5	Josh JONES	10 - 0	1:01	IPO
E-34	Satvik SOOD	2	4	Ian VAN STYGEREN	0 - 10	0:49	IPO
E-51	Nikolay CHUKALOVSKIY	1	3	Cai JAMES	10 - 0	0:00	FUS
E-52	Satvik SOOD	2	5	Josh JONES	0 - 10	0:52	WIP

## Results/Résultats

Pos	Name/Nom
1	Nikolay CHUKALOVSKIY, IPÊ DOJO
2	Cai JAMES, Balmoral
3	Ian VAN STYGEREN, Huntsville
4	Josh JONES, Huntsville

# Seniors Int Male -60kg

## Competitors/Compétiteurs

#	Name/Nom	Grade	Club	1	2	3	W/G	Pts	Pos
1	Bryce CHAPMAN	Green	Kanokai	XX	10		1	10	2
2	Tristan SINGH	Green	Spryfield		XX		0	0	3
3	Braydin NGUYEN	Blue	Inner City	10	10	XX	2	20	1

## Matches/Matches

Match	White/Blanc			Blue/Bleu	Res/Rés	Tim/Tmp	Code
B-17	<b>Bryce CHAPMAN</b>	1	2	Tristan SINGH	10 - 0	2:32	IPO
B-29	Bryce CHAPMAN	1	3	<b>Braydin NGUYEN</b>	0 - 10	0:09	IPO
B-41	Tristan SINGH	2	3	<b>Braydin NGUYEN</b>	0 - 10	0:33	IPO

## Results/Résultats

Pos	Name/Nom
1	Braydin NGUYEN, Inner City
2	Bryce CHAPMAN, Kanokai



# Seniors Int Male -70kg

## Competitors/Compétiteurs

#	Name/Nom	Grade	Club	1	2	3	4	5	W/G	Pts	Pos
1	Oleksandr HAVRYSHCHUK	Blue	Olympic	XX	10	10	10	10	4	40	1
2	Billy-Joe BALDONADO	Blue	Ishi Yama		XX	10	10	10	3	30	2
3	Soren ANDREASSEN	Blue	Abbotsford			XX	10		1	10	4
4	Ivan LEE	Blue	Scarborough				XX		0	0	5
5	Thomas LIAO	Blue	U of Toronto			10	10	XX	2	20	3

## Matches/Matches

Match	White/Blanc			Blue/Bleu	Res/Rés	Tim/Tmp	Code
A-17	Ivan LEE	4	5	<b>Thomas LIAO</b>	0 - 10	0:34	IPO
A-18	<b>Oleksandr HAVRYSHCHUK</b>	1	2	Billy-Joe BALDONADO	10 - 0	1:50	IPO
A-25	<b>Soren ANDREASSEN</b>	3	4	Ivan LEE	10 - 0	0:42	IPO
A-26	<b>Oleksandr HAVRYSHCHUK</b>	1	5	Thomas LIAO	10 - 0	3:53	IPO
A-33	<b>Billy-Joe BALDONADO</b>	2	3	Soren ANDREASSEN	10 - 0	0:15	IPO
A-34	<b>Oleksandr HAVRYSHCHUK</b>	1	4	Ivan LEE	10 - 0	2:04	WIP
A-43	Soren ANDREASSEN	3	5	<b>Thomas LIAO</b>	0 - 10	1:25	IPO
A-44	<b>Billy-Joe BALDONADO</b>	2	4	Ivan LEE	10 - 0	1:30	IPO
A-50	<b>Oleksandr HAVRYSHCHUK</b>	1	3	Soren ANDREASSEN	10 - 0	4:27	IPO
A-51	<b>Billy-Joe BALDONADO</b>	2	5	Thomas LIAO	10 - 0	0:56	WIP

## Results/Résultats

Pos	Name/Nom
1	Oleksandr HAVRYSHCHUK, Olympic
2	Billy-Joe BALDONADO, Ishi Yama
3	Thomas LIAO, U of Toronto
4	Soren ANDREASSEN, Abbotsford

# Seniors Int Male -80kg

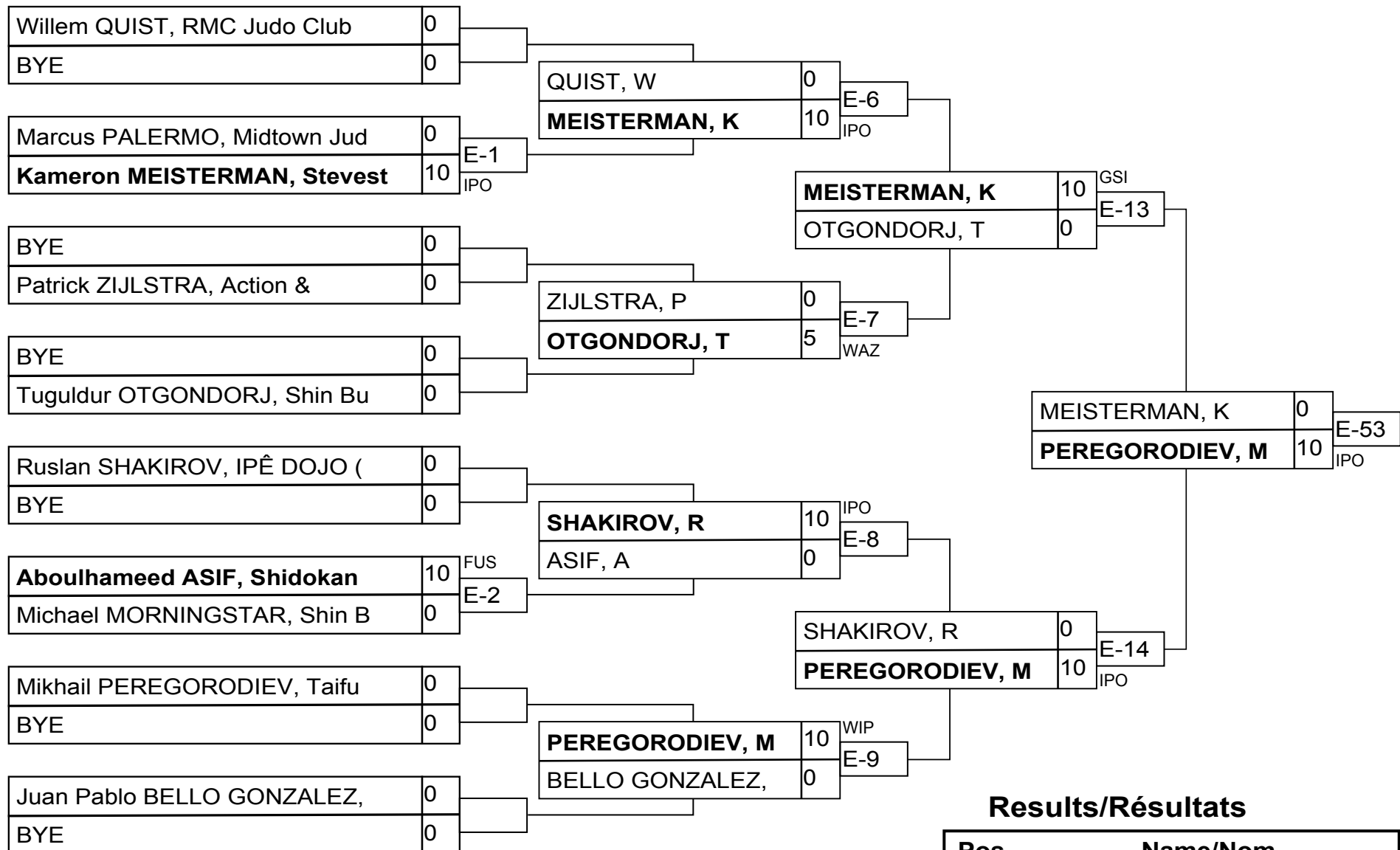

## Results/Résultats

Pos	Name/Nom
1	Mikhail PEREGORODIEV, Ta
2	Kameron MEISTERMAN, Stev
3	Tuguldur OTGONDORJ, Shin
3	Ruslan SHAKIROV, IPÊ DOJ

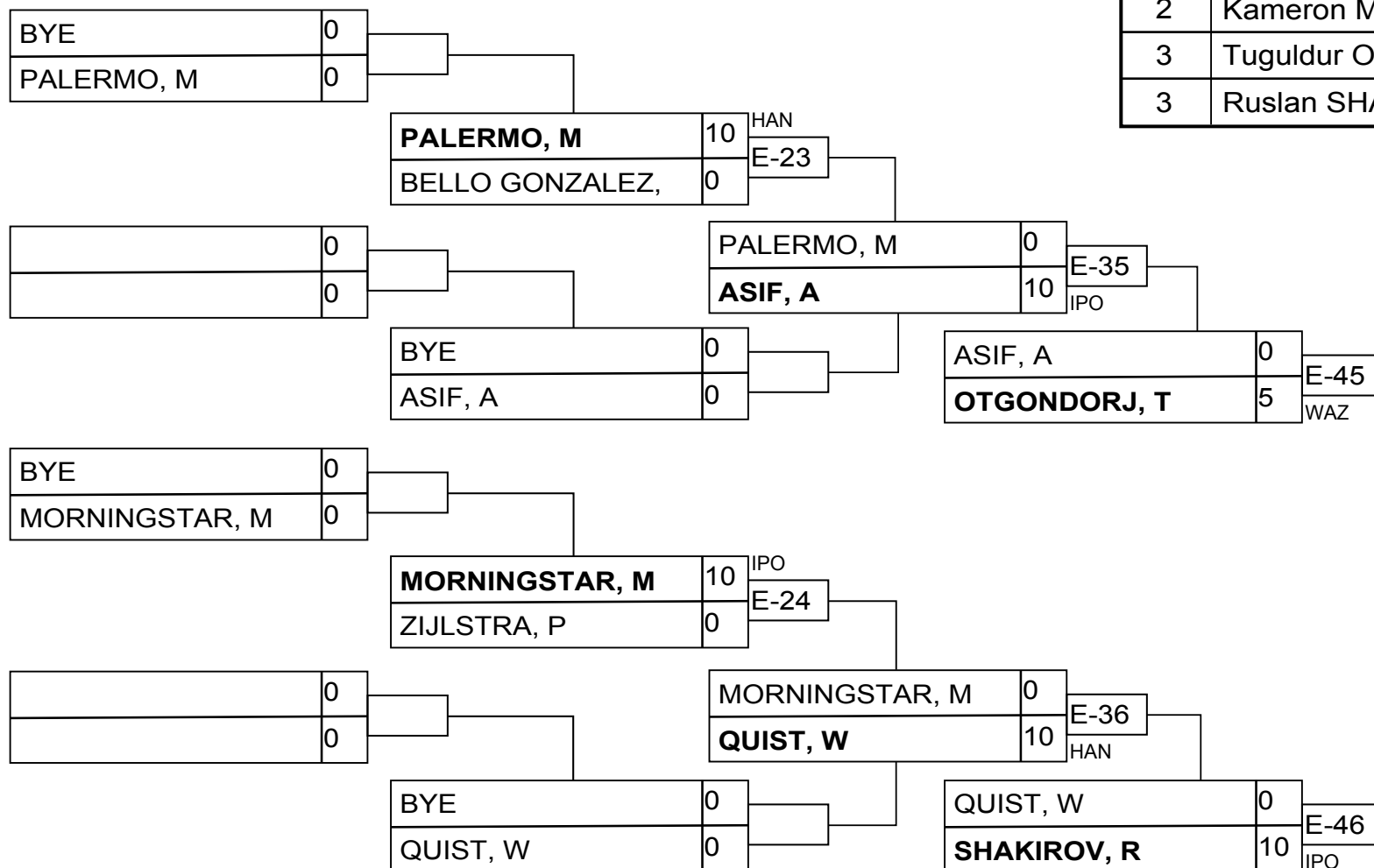

# Seniors Int Male -90kg

## Competitors/Compétiteurs A

#	Name/Nom	Grade	Club	1	2	3	4	W/G	Pts	Pos
1	Luca DE CICCIO	Green	RMC Judo Club	XX			10	1	10	3
2	Rhys BESSON	Green	RMC Judo Club	10	XX		10	2	20	2
3	Amir SAID MOHAMMAD	Blue	Kodokwai	10	10	XX	10	3	30	1
4	Justin GAFAR	Green	Shin Bu Kan (ON)				XX	0	0	4

## Pool A

Match	White/Blanc	Blue/Bleu	Res/Rés	Tim/Tmp	Code
E-18	Luca DE CICCIO 1 2	Rhys BESSON	0 - 10	0:16	IPO
E-19	Amir SAID MOHAMMAD 3 4	Justin GAFAR	10 - 0	2:49	IPO
E-30	Luca DE CICCIO 1 3	Amir SAID MOHAMMAD	0 - 10	3:14	IPO
E-31	Rhys BESSON 2 4	Justin GAFAR	10 - 0	0:03	FUS
E-42	Luca DE CICCIO 1 4	Justin GAFAR	10 - 0	0:00	FUS
E-43	Rhys BESSON 2 3	Amir SAID MOHAMMAD	0 - 10	2:43	IPO

## Competitors/Compétiteurs B

#	Name/Nom	Grade	Club	5	6	7	W/G	Pts	Pos
5	John TURNER	Green	RMC Judo Club	XX	10	10	2	20	1
6	Daniel KNOWLTON	Green	Annex		XX		0	0	3
7	Abdulrahman BAHABRI	Blue	Kohbukan-Sisu		10	XX	1	10	2

## Pool B

Match	White/Blanc	Blue/Bleu	Res/Rés	Tim/Tmp	Code
E-20	John TURNER 5 6	Daniel KNOWLTON	10 - 0	0:11	IPO
E-32	John TURNER 5 7	Abdulrahman BAHABRI	10 - 0	0:45	IPO
E-44	Daniel KNOWLTON 6 7	Abdulrahman BAHABRI	0 - 10	2:27	IPO

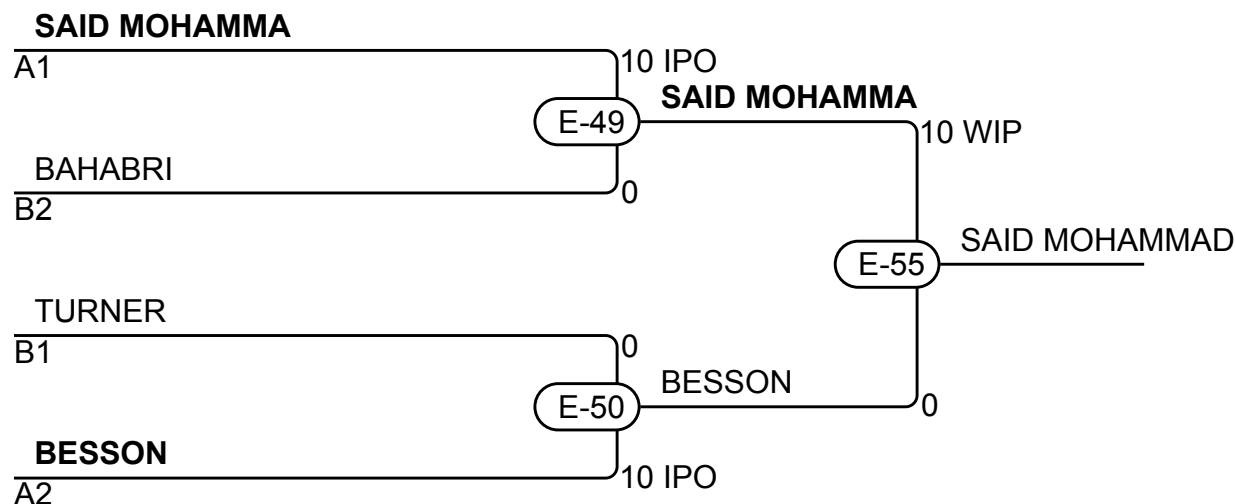

## Results/Résultats

Pos	Name/Nom
1	Amir SAID MOHAMMAD, Kodokwai
2	Rhys BESSON, RMC Judo Club
3	Abdulrahman BAHABRI, Kohbukan-Sisu
3	John TURNER, RMC Judo Club

# Seniors Int Male +100kg

## Competitors/Compétiteurs

#	Name/Nom	Grade	Club	1	2	3	4	W/G	Pts	Pos
1	Robbinlee ITURRALDE	Green	IPÊ DOJO	XX	10	10		2	20	2
2	Jordan JONES	Green	Huntsville		XX	10		1	10	3
3	Carl LIVINGSTONE	Green	Midtown Judo - Kiyomizuk			XX		0	0	4
4	Rahman DISU	Green	R.A.	10	10	10	XX	3	30	1

## Matches/Matches

Match	White/Blanc			Blue/Bleu	Res/Rés	Tim/Tmp	Code
C-29	<b>Robbinlee ITURRALDE</b>	1	2	Jordan JONES	10 - 0	1:23	IPO
C-30	Carl LIVINGSTONE	3	4	<b>Rahman DISU</b>	0 - 10	0:30	IPO
C-43	<b>Robbinlee ITURRALDE</b>	1	3	Carl LIVINGSTONE	10 - 0	0:22	IPO
C-44	Jordan JONES	2	4	<b>Rahman DISU</b>	0 - 10	0:24	IPO
C-53	Robbinlee ITURRALDE	1	4	<b>Rahman DISU</b>	0 - 10	1:06	IPO
C-54	<b>Jordan JONES</b>	2	3	Carl LIVINGSTONE	10 - 0	0:34	IPO

## Results/Résultats

Pos	Name/Nom
1	Rahman DISU, R.A.
2	Robbinlee ITURRALDE, IPÊ DOJO
3	Jordan JONES, Huntsville

# Seniors Male Open Weight

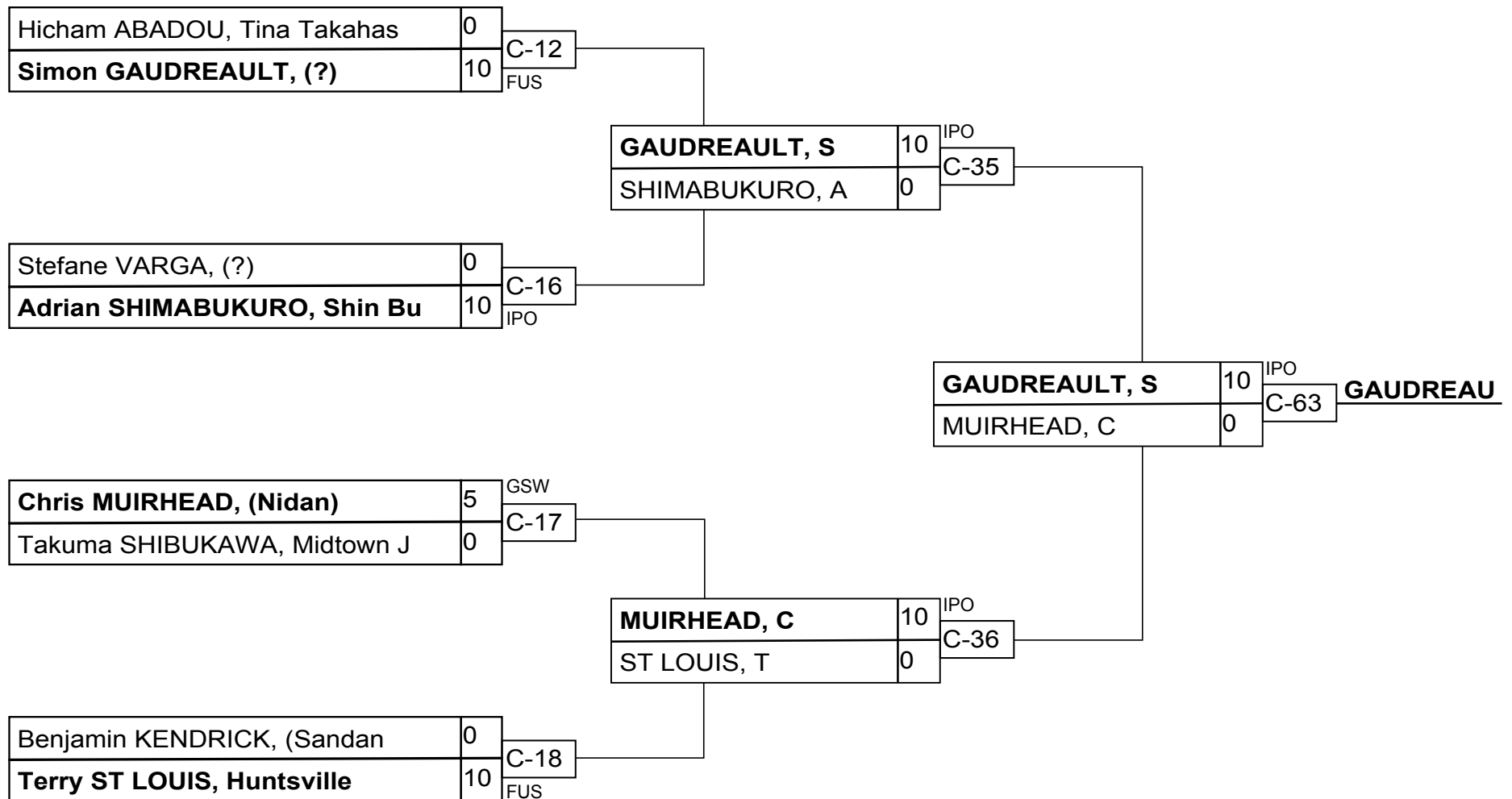

## Results/Résultats

Pos	Name/Nom
1	Simon GAUDREULT, (?)
2	Chris MUIRHEAD, (Nidan)
3	Adrian SHIMABUKURO, Shin
3	Terry ST LOUIS, Huntsvil

# U16 Female -36kg

## Competitors/Compétiteurs

#	Name/Nom	Grade	Club	1	2	1	2	1	2	W/G	Pts	Pos
1	Rylee SYER	Green	Airdrie	XX		XX		XX		0	0	2
2	Aimy TREMBLAY	Blue	Chicoutimi	10	XX	10	XX		XX	2	20	1

## Matches/Matches

Match	White/Blanc			Blue/Bleu	Res/Rés	Tim/Tmp	Code
B-28	Rylee SYER	1	2	Aimy TREMBLAY	0 - 10	0:46	IPO
B-38	Aimy TREMBLAY	2	1	Rylee SYER	10 - 0	1:07	IPO
B-48	Rylee SYER	1	2	Aimy TREMBLAY			

## Results/Résultats

Pos	Name/Nom
1	Aimy TREMBLAY, Chicoutimi

# U16 Female -40kg

## Competitors/Compétiteurs

#	Name/Nom	Grade	Club	1	2	3	4	W/G	Pts	Pos
1	Marianna SCHESNUIK	Blue	Judo Kai	XX	10	10		2	20	2
2	Ariane TURMEL	Green	Blainville		XX	10		1	10	3
3	Brooklyn SEEMAN	Green	Lethbridge			XX		0	0	4
4	Vanessa COVASER	Blue	Peak Judo Club	10	10	10	XX	3	30	1

## Matches/Matches

Match	White/Blanc			Blue/Bleu	Res/Rés	Tim/Tmp	Code
E-16	<b>Marianna SCHESNUIK</b>	1	2	Ariane TURMEL	10 - 0	1:30	WIP
E-17	Brooklyn SEEMAN	3	4	<b>Vanessa COVASER</b>	0 - 10	0:21	IPO
E-28	<b>Marianna SCHESNUIK</b>	1	3	Brooklyn SEEMAN	10 - 0	1:56	IPO
E-29	Ariane TURMEL	2	4	<b>Vanessa COVASER</b>	0 - 10	0:37	IPO
E-40	Marianna SCHESNUIK	1	4	<b>Vanessa COVASER</b>	0 - 10	4:09	GSI
E-41	<b>Ariane TURMEL</b>	2	3	Brooklyn SEEMAN	10 - 0	0:00	IPO

## Results/Résultats

Pos	Name/Nom
1	Vanessa COVASER, Peak Judo Club
2	Marianna SCHESNUIK, Judo Kai
3	Ariane TURMEL, Blainville

# U16 Female -44kg

## Competitors/Compétiteurs

#	Name/Nom	Grade	Club	1	2	3	4	5	W/G	Pts	Pos
1	Laila SO	Green	Asahi	XX		10			1	10	4
2	Claire DIOME	Green	Tritton	10	XX	5		10	3	25	2
3	Anna LI	Green	University Of Regina Jud			XX			0	0	5
4	Jaelyn ABRAHAM	Green	Scarborough	10	10	5	XX	10	4	35	1
5	Yixuan SHAO	Green	Hayabusakan	10		10		XX	2	20	3

## Matches/Matches

Match	White/Blanc			Blue/Bleu	Res/Rés	Tim/Tmp	Code
D-4	<b>Jaelyn ABRAHAM</b>	4	5	Yixuan SHAO	10 - 0	0:49	IPO
D-5	Laila SO	1	2	<b>Claire DIOME</b>	0 - 10	1:00	WIP
D-16	Anna LI	3	4	<b>Jaelyn ABRAHAM</b>	0 - 5	3:00	WAZ
D-17	Laila SO	1	5	<b>Yixuan SHAO</b>	0 - 10	1:04	WIP
D-22	<b>Claire DIOME</b>	2	3	Anna LI	5 - 0	3:00	WAZ
D-23	Laila SO	1	4	<b>Jaelyn ABRAHAM</b>	0 - 10	0:57	IPO
D-30	Anna LI	3	5	<b>Yixuan SHAO</b>	0 - 10	1:23	WIP
D-31	Claire DIOME	2	4	<b>Jaelyn ABRAHAM</b>	0 - 10	2:24	IPO
D-39	<b>Laila SO</b>	1	3	Anna LI	10 - 0	0:30	WIP
D-40	<b>Claire DIOME</b>	2	5	Yixuan SHAO	10 - 0	0:24	IPO

## Results/Résultats

Pos	Name/Nom
1	Jaelyn ABRAHAM, Scarborough
2	Claire DIOME, Tritton
3	Yixuan SHAO, Hayabusakan
4	Laila SO, Asahi



# U16 Female -48kg

## Competitors/Compétiteurs A

#	Name/Nom	Grade	Club	1	2	3	4	W/G	Pts	Pos
1	Ksenia OUDOVIKINE	Green	Taifu	XX			10	1	10	3
2	Nikole-Daria MANAILA	Green	Ippon	10	XX	10	10	3	30	1
3	Marisol SAVOIE	Brown	Otoshi Dieppe	10		XX	10	2	20	2
4	Abigail YIN	Blue	Prince George				XX	0	0	4

## Pool A

Match	White/Blanc	Blue/Bleu	Res/Rés	Tim/Tmp	Code
C-13	Ksenia OUDOVIKINE 1 2	Nikole-Daria MANAILA	0 - 10	1:12	WIP
C-14	Marisol SAVOIE 3 4	Abigail YIN	10 - 0	0:06	IPO
C-19	Ksenia OUDOVIKINE 1 3	Marisol SAVOIE	0 - 10	2:35	HAN
C-20	Nikole-Daria MANAILA 2 4	Abigail YIN	10 - 0	0:08	IPO
C-26	Ksenia OUDOVIKINE 1 4	Abigail YIN	10 - 0	0:16	IPO
C-27	Nikole-Daria MANAILA 2 3	Marisol SAVOIE	10 - 0	0:37	WIP

## Competitors/Compétiteurs B

#	Name/Nom	Grade	Club	5	6	7	W/G	Pts	Pos
5	Christina KARAS	Blue	Kodokwai	XX	5	5	2	10	1
6	Laura SCORTEANU	Green	Shidokan		XX		0	0	3
7	Wish KEIRSTEAD	Brown	Pacific Kodokan Dojo		10	XX	1	10	2

## Pool B

Match	White/Blanc	Blue/Bleu	Res/Rés	Tim/Tmp	Code
C-15	Christina KARAS 5 6	Laura SCORTEANU	5 - 0	9:23	GSW
C-21	Christina KARAS 5 7	Wish KEIRSTEAD	5 - 0	3:00	WAZ
C-28	Laura SCORTEANU 6 7	Wish KEIRSTEAD	0 - 10	0:00	FUS

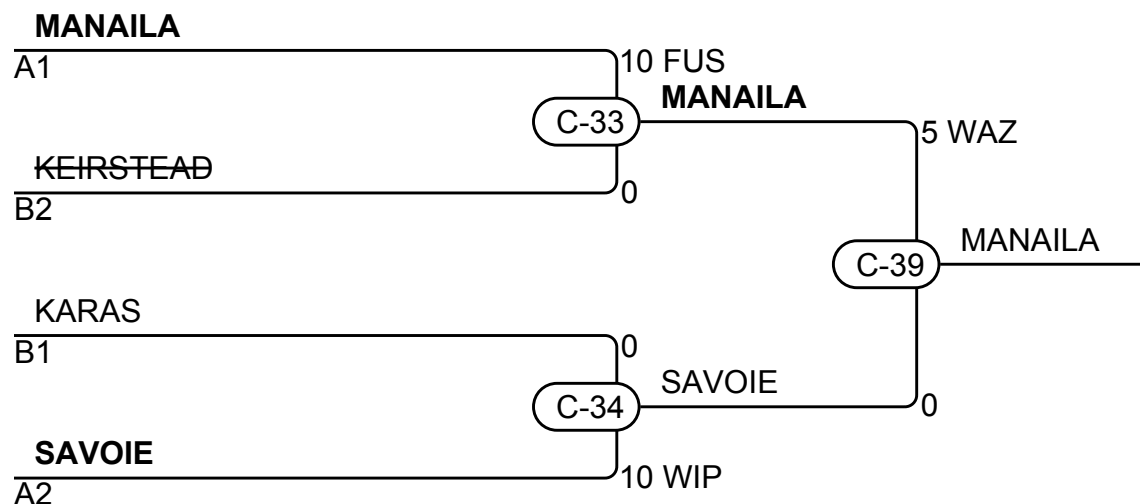

## Results/Résultats

Pos	Name/Nom
1	Nikole-Daria MANAILA, Ippon
2	Marisol SAVOIE, Otoshi Dieppe
3	Wish KEIRSTEAD, Pacific Kodokan Dojo
3	Christina KARAS, Kodokwai

# U16 Female -52kg

## Competitors/Compétiteurs

#	Name/Nom	Grade	Club	1	2	3	4	5	W/G	Pts	Pos
1	Sadie WESTFALL	Blue	Upper Canada	XX			10		1	10	4
2	Abygail LAPLANTE	Green	Seikidokan (QC)	10	XX		10		2	20	3
3	Emma TRITTON	Blue	Tritton	10	10	XX	10	10	4	40	1
4	Hannah CUKIER	Blue	Kawasaki				XX		0	0	5
5	Katalina SANCHEZ	Blue	Kawasaki	10	10		10	XX	3	30	2

## Matches/Matches

Match	White/Blanc			Blue/Bleu	Res/Rés	Tim/Tmp	Code
B-14	Hannah CUKIER	4	5	<b>Katalina SANCHEZ</b>	0 - 10	0:54	WIP
B-15	Sadie WESTFALL	1	2	<b>Abygail LAPLANTE</b>	0 - 10	2:07	WIP
B-19	<b>Emma TRITTON</b>	3	4	Hannah CUKIER	10 - 0	0:25	IPO
B-20	Sadie WESTFALL	1	5	<b>Katalina SANCHEZ</b>	0 - 10	3:24	WIP
B-26	Abygail LAPLANTE	2	3	<b>Emma TRITTON</b>	0 - 10	2:35	HAN
B-27	<b>Sadie WESTFALL</b>	1	4	Hannah CUKIER	10 - 0	0:49	WIP
B-36	<b>Emma TRITTON</b>	3	5	Katalina SANCHEZ	10 - 0	1:12	IPO
B-37	<b>Abygail LAPLANTE</b>	2	4	Hannah CUKIER	10 - 0	0:56	IPO
B-46	Sadie WESTFALL	1	3	<b>Emma TRITTON</b>	0 - 10	0:20	IPO
B-47	Abygail LAPLANTE	2	5	<b>Katalina SANCHEZ</b>	0 - 10	1:00	IPO

## Results/Résultats

Pos	Name/Nom
1	Emma TRITTON, Tritton
2	Katalina SANCHEZ, Kawasaki
3	Abygail LAPLANTE, Seikidokan (QC)
4	Sadie WESTFALL, Upper Canada

# U16 Female -57kg

## Competitors/Compétiteurs

#	Name/Nom	Grade	Club	1	2	3	4	5	W/G	Pts	Pos
1	Meihao REN	Green	Sheffield	XX					0	0	5
2	Avery FAM	Green	Ninja	10	XX				1	10	4
3	Maxim LAVOIE	Blue	Beauport	10	10	XX			2	20	3
4	Camila HEBER	Blue	Tokugawa	10	10	5	XX		3	25	2
5	Annaka DEEG	Blue	Tokugawa	10	10	10	10	XX	4	40	1

## Matches/Matches

Match	White/Blanc			Blue/Bleu	Res/Rés	Tim/Tmp	Code
D-14	Camila HEBER	4	5	Annaka DEEG	0 - 10	0:05	IPO
D-15	Meihao REN	1	2	Avery FAM	0 - 10	0:00	FUS
D-20	Maxim LAVOIE	3	4	Camila HEBER	0 - 5	3:55	GSW
D-21	Meihao REN	1	5	Annaka DEEG	0 - 10	0:00	FUS
D-28	Avery FAM	2	3	Maxim LAVOIE	0 - 10	0:43	WIP
D-29	Meihao REN	1	4	Camila HEBER	0 - 10	0:04	FUS
D-37	Maxim LAVOIE	3	5	Annaka DEEG	0 - 10	0:22	IPO
D-38	Avery FAM	2	4	Camila HEBER	0 - 10	0:06	IPO
D-47	Meihao REN	1	3	Maxim LAVOIE	0 - 10	0:00	FUS
D-48	Avery FAM	2	5	Annaka DEEG	0 - 10	0:00	IPO

## Results/Résultats

Pos	Name/Nom
1	Annaka DEEG, Tokugawa
2	Camila HEBER, Tokugawa
3	Maxim LAVOIE, Beauport
4	Avery FAM, Ninja

# U16 Female -63kg

## Competitors/Compétiteurs A

#	Name/Nom	Grade	Club	1	2	3	W/G	Pts	Pos
1	Ahniia GREBENNIKOVA	Blue	Annex	XX			0	0	3
2	Victoria SUMMERS	Brown	Ajax Budokan	10	XX	10	2	20	1
3	Juliette PÉRUSSE	Green	Sakura (QC)	10		XX	1	10	2

## Pool A

Match	White/Blanc	Blue/Bleu	Res/Rés	Tim/Tmp	Code
A-13	Ahniia GREBENNIKOVA 1 2	Victoria SUMMERS	0 - 10	0:28	WIP
A-23	Ahniia GREBENNIKOVA 1 3	Juliette PÉRUSSE	0 - 10	0:30	IPO
A-29	Victoria SUMMERS 2 3	Juliette PÉRUSSE	10 - 0	1:13	WIP

## Competitors/Compétiteurs B

#	Name/Nom	Grade	Club	4	5	6	W/G	Pts	Pos
4	Olivia BECKETT	Blue	Prince George	XX			0	0	3
5	Finley MORASCH	Blue	Lethbridge	10	XX		1	10	2
6	Angelina KIORESKOU	Blue	Shin Bu Kan (ON)	10	10	XX	2	20	1

## Pool B

Match	White/Blanc	Blue/Bleu	Res/Rés	Tim/Tmp	Code
A-14	Olivia BECKETT 4 5	Finley MORASCH	0 - 10	0:23	WIP
A-24	Olivia BECKETT 4 6	Angelina KIORESKOU	0 - 10	0:33	IPO
A-30	Finley MORASCH 5 6	Angelina KIORESKOU	0 - 10	0:26	IPO

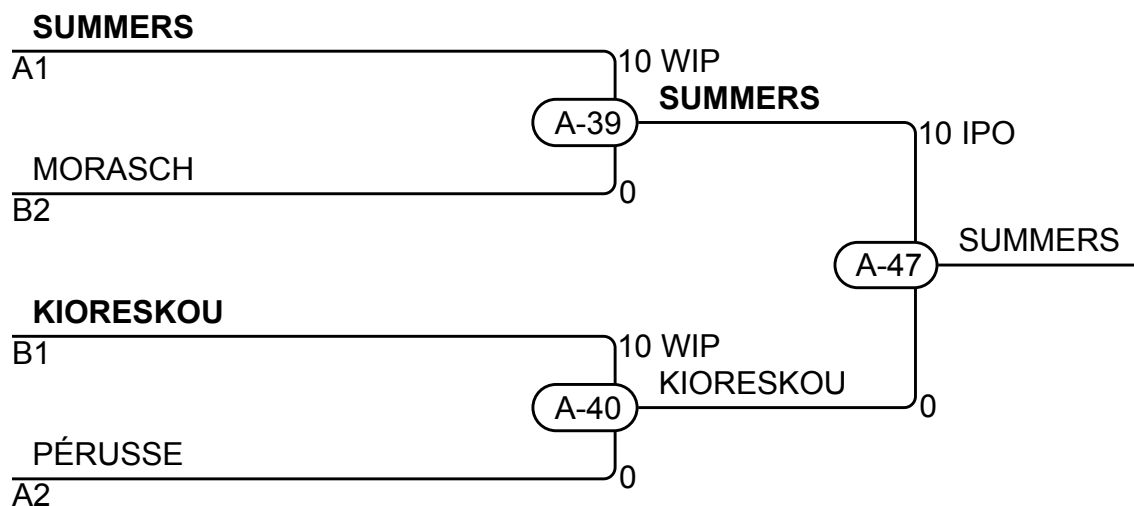

## Results/Résultats

Pos	Name/Nom
1	Victoria SUMMERS, Ajax Budokan
2	Angelina KIORESKOU, Shin Bu Kan (ON)
3	Finley MORASCH, Lethbridge
3	Juliette PÉRUSSE, Sakura (QC)

# U16 Female -70kg

## Competitors/Compétiteurs

#	Name/Nom	Grade	Club	1	2	3	4	5	W/G	Pts	Pos
1	Silesitiale CHAMBERS	Green	Sheffield	XX					0	0	5
2	Azra BENIC	Green	Saskatoon Y	10	XX				1	10	4
3	Emiliya ALIYEVA	Blue	Hiro's	10	10	XX	10	10	4	40	1
4	Malak AZAR	Green	Shidokan	10	10		XX	10	3	30	2
5	Abby LAVOIE	Blue	Seikidokan (QC)	10	10			XX	2	20	3

## Matches/Matches

Match	White/Blanc			Blue/Bleu	Res/Rés	Tim/Tmp	Code
C-4	<b>Malak AZAR</b>	4	5	Abby LAVOIE	10 - 0	0:40	WIP
C-5	Silesitiale CHAMBERS	1	2	<b>Azra BENIC</b>	0 - 10	1:43	IPO
C-10	<b>Emiliya ALIYEVA</b>	3	4	Malak AZAR	10 - 0	0:58	IPO
C-11	Silesitiale CHAMBERS	1	5	<b>Abby LAVOIE</b>	0 - 10	1:39	IPO
C-22	Azra BENIC	2	3	<b>Emiliya ALIYEVA</b>	0 - 10	0:20	IPO
C-23	Silesitiale CHAMBERS	1	4	<b>Malak AZAR</b>	0 - 10	0:10	IPO
C-37	<b>Emiliya ALIYEVA</b>	3	5	Abby LAVOIE	10 - 0	1:08	IPO
C-38	Azra BENIC	2	4	<b>Malak AZAR</b>	0 - 10	0:16	IPO
C-47	Silesitiale CHAMBERS	1	3	<b>Emiliya ALIYEVA</b>	0 - 10	0:53	IPO
C-48	Azra BENIC	2	5	<b>Abby LAVOIE</b>	0 - 10	2:01	IPO

## Results/Résultats

Pos	Name/Nom
1	Emiliya ALIYEVA, Hiro's
2	Malak AZAR, Shidokan
3	Abby LAVOIE, Seikidokan (QC)
4	Azra BENIC, Saskatoon Y

# U16 Female -44kg

## Competitors/Compétiteurs

#	Name/Nom	Grade	Club	1	2	3	4	5	W/G	Pts	Pos
1	Laila SO	Green	Asahi	XX		10			1	10	4
2	Claire DIOME	Green	Tritton	10	XX	5		10	3	25	2
3	Anna LI	Green	University Of Regina Jud			XX			0	0	5
4	Jaelyn ABRAHAM	Green	Scarborough	10	10	5	XX	10	4	35	1
5	Yixuan SHAO	Green	Hayabusakan	10		10		XX	2	20	3

## Matches/Matches

Match	White/Blanc			Blue/Bleu	Res/Rés	Tim/Tmp	Code
D-4	<b>Jaelyn ABRAHAM</b>	4	5	Yixuan SHAO	10 - 0	0:49	IPO
D-5	Laila SO	1	2	<b>Claire DIOME</b>	0 - 10	1:00	WIP
D-16	Anna LI	3	4	<b>Jaelyn ABRAHAM</b>	0 - 5	3:00	WAZ
D-17	Laila SO	1	5	<b>Yixuan SHAO</b>	0 - 10	1:04	WIP
D-22	<b>Claire DIOME</b>	2	3	Anna LI	5 - 0	3:00	WAZ
D-23	Laila SO	1	4	<b>Jaelyn ABRAHAM</b>	0 - 10	0:57	IPO
D-30	Anna LI	3	5	<b>Yixuan SHAO</b>	0 - 10	1:23	WIP
D-31	Claire DIOME	2	4	<b>Jaelyn ABRAHAM</b>	0 - 10	2:24	IPO
D-39	<b>Laila SO</b>	1	3	Anna LI	10 - 0	0:30	WIP
D-40	<b>Claire DIOME</b>	2	5	Yixuan SHAO	10 - 0	0:24	IPO

## Results/Résultats

Pos	Name/Nom
1	Jaelyn ABRAHAM, Scarborough
2	Claire DIOME, Tritton
3	Yixuan SHAO, Hayabusakan
4	Laila SO, Asahi

# U16 Female -48kg

## Competitors/Compétiteurs A

#	Name/Nom	Grade	Club	1	2	3	4	W/G	Pts	Pos
1	Ksenia OUDOVIKINE	Green	Taifu	XX			10	1	10	3
2	Nikole-Daria MANAILA	Green	Ippon	10	XX	10	10	3	30	1
3	Marisol SAVOIE	Brown	Otoshi Dieppe	10		XX	10	2	20	2
4	Abigail YIN	Blue	Prince George				XX	0	0	4

## Pool A

Match	White/Blanc	Blue/Bleu	Res/Rés	Tim/Tmp	Code
C-13	Ksenia OUDOVIKINE 1 2	Nikole-Daria MANAILA	0 - 10	1:12	WIP
C-14	Marisol SAVOIE 3 4	Abigail YIN	10 - 0	0:06	IPO
C-19	Ksenia OUDOVIKINE 1 3	Marisol SAVOIE	0 - 10	2:35	HAN
C-20	Nikole-Daria MANAILA 2 4	Abigail YIN	10 - 0	0:08	IPO
C-26	Ksenia OUDOVIKINE 1 4	Abigail YIN	10 - 0	0:16	IPO
C-27	Nikole-Daria MANAILA 2 3	Marisol SAVOIE	10 - 0	0:37	WIP

## Competitors/Compétiteurs B

#	Name/Nom	Grade	Club	5	6	7	W/G	Pts	Pos
5	Christina KARAS	Blue	Kodokwai	XX	5	5	2	10	1
6	Laura SCORTEANU	Green	Shidokan		XX		0	0	3
7	Wish KEIRSTEAD	Brown	Pacific Kodokan Dojo		10	XX	1	10	2

## Pool B

Match	White/Blanc	Blue/Bleu	Res/Rés	Tim/Tmp	Code
C-15	Christina KARAS 5 6	Laura SCORTEANU	5 - 0	9:23	GSW
C-21	Christina KARAS 5 7	Wish KEIRSTEAD	5 - 0	3:00	WAZ
C-28	Laura SCORTEANU 6 7	Wish KEIRSTEAD	0 - 10	0:00	FUS

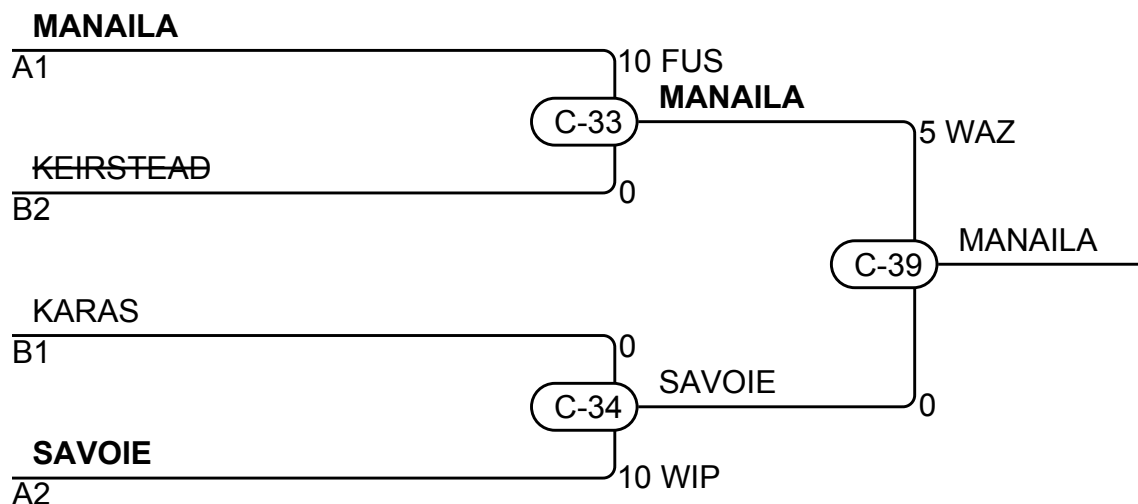

## Results/Résultats

Pos	Name/Nom
1	Nikole-Daria MANAILA, Ippon
2	Marisol SAVOIE, Otoshi Dieppe
3	Wish KEIRSTEAD, Pacific Kodokan Dojo
3	Christina KARAS, Kodokwai

# U16 Female -52kg

## Competitors/Compétiteurs

#	Name/Nom	Grade	Club	1	2	3	4	5	W/G	Pts	Pos
1	Sadie WESTFALL	Blue	Upper Canada	XX			10		1	10	4
2	Abygail LAPLANTE	Green	Seikidokan (QC)	10	XX		10		2	20	3
3	Emma TRITTON	Blue	Tritton	10	10	XX	10	10	4	40	1
4	Hannah CUKIER	Blue	Kawasaki				XX		0	0	5
5	Katalina SANCHEZ	Blue	Kawasaki	10	10		10	XX	3	30	2

## Matches/Matches

Match	White/Blanc			Blue/Bleu	Res/Rés	Tim/Tmp	Code
B-14	Hannah CUKIER	4	5	<b>Katalina SANCHEZ</b>	0 - 10	0:54	WIP
B-15	Sadie WESTFALL	1	2	<b>Abygail LAPLANTE</b>	0 - 10	2:07	WIP
B-19	<b>Emma TRITTON</b>	3	4	Hannah CUKIER	10 - 0	0:25	IPO
B-20	Sadie WESTFALL	1	5	<b>Katalina SANCHEZ</b>	0 - 10	3:24	WIP
B-26	Abygail LAPLANTE	2	3	<b>Emma TRITTON</b>	0 - 10	2:35	HAN
B-27	<b>Sadie WESTFALL</b>	1	4	Hannah CUKIER	10 - 0	0:49	WIP
B-36	<b>Emma TRITTON</b>	3	5	Katalina SANCHEZ	10 - 0	1:12	IPO
B-37	<b>Abygail LAPLANTE</b>	2	4	Hannah CUKIER	10 - 0	0:56	IPO
B-46	Sadie WESTFALL	1	3	<b>Emma TRITTON</b>	0 - 10	0:20	IPO
B-47	Abygail LAPLANTE	2	5	<b>Katalina SANCHEZ</b>	0 - 10	1:00	IPO

## Results/Résultats

Pos	Name/Nom
1	Emma TRITTON, Tritton
2	Katalina SANCHEZ, Kawasaki
3	Abygail LAPLANTE, Seikidokan (QC)
4	Sadie WESTFALL, Upper Canada



# U16 Female -57kg

## Competitors/Compétiteurs

#	Name/Nom	Grade	Club	1	2	3	4	5	W/G	Pts	Pos
1	Meihao REN	Green	Sheffield	XX					0	0	5
2	Avery FAM	Green	Ninja	10	XX				1	10	4
3	Maxim LAVOIE	Blue	Beauport	10	10	XX			2	20	3
4	Camila HEBER	Blue	Tokugawa	10	10	5	XX		3	25	2
5	Annaka DEEG	Blue	Tokugawa	10	10	10	10	XX	4	40	1

## Matches/Matches

Match	White/Blanc			Blue/Bleu	Res/Rés	Tim/Tmp	Code
D-14	Camila HEBER	4	5	Annaka DEEG	0 - 10	0:05	IPO
D-15	Meihao REN	1	2	Avery FAM	0 - 10	0:00	FUS
D-20	Maxim LAVOIE	3	4	Camila HEBER	0 - 5	3:55	GSW
D-21	Meihao REN	1	5	Annaka DEEG	0 - 10	0:00	FUS
D-28	Avery FAM	2	3	Maxim LAVOIE	0 - 10	0:43	WIP
D-29	Meihao REN	1	4	Camila HEBER	0 - 10	0:04	FUS
D-37	Maxim LAVOIE	3	5	Annaka DEEG	0 - 10	0:22	IPO
D-38	Avery FAM	2	4	Camila HEBER	0 - 10	0:06	IPO
D-47	Meihao REN	1	3	Maxim LAVOIE	0 - 10	0:00	FUS
D-48	Avery FAM	2	5	Annaka DEEG	0 - 10	0:00	IPO

## Results/Résultats

Pos	Name/Nom
1	Annaka DEEG, Tokugawa
2	Camila HEBER, Tokugawa
3	Maxim LAVOIE, Beauport
4	Avery FAM, Ninja

# U16 Female -63kg

## Competitors/Compétiteurs A

#	Name/Nom	Grade	Club	1	2	3	W/G	Pts	Pos
1	Ahniia GREBENNIKOVA	Blue	Annex	XX			0	0	3
2	Victoria SUMMERS	Brown	Ajax Budokan	10	XX	10	2	20	1
3	Juliette PÉRUSSE	Green	Sakura (QC)	10		XX	1	10	2

## Pool A

Match	White/Blanc	Blue/Bleu	Res/Rés	Tim/Tmp	Code
A-13	Ahniia GREBENNIKOVA 1 2	Victoria SUMMERS	0 - 10	0:28	WIP
A-23	Ahniia GREBENNIKOVA 1 3	Juliette PÉRUSSE	0 - 10	0:30	IPO
A-29	Victoria SUMMERS 2 3	Juliette PÉRUSSE	10 - 0	1:13	WIP

## Competitors/Compétiteurs B

#	Name/Nom	Grade	Club	4	5	6	W/G	Pts	Pos
4	Olivia BECKETT	Blue	Prince George	XX			0	0	3
5	Finley MORASCH	Blue	Lethbridge	10	XX		1	10	2
6	Angelina KIORESKOU	Blue	Shin Bu Kan (ON)	10	10	XX	2	20	1

## Pool B

Match	White/Blanc	Blue/Bleu	Res/Rés	Tim/Tmp	Code
A-14	Olivia BECKETT 4 5	Finley MORASCH	0 - 10	0:23	WIP
A-24	Olivia BECKETT 4 6	Angelina KIORESKOU	0 - 10	0:33	IPO
A-30	Finley MORASCH 5 6	Angelina KIORESKOU	0 - 10	0:26	IPO

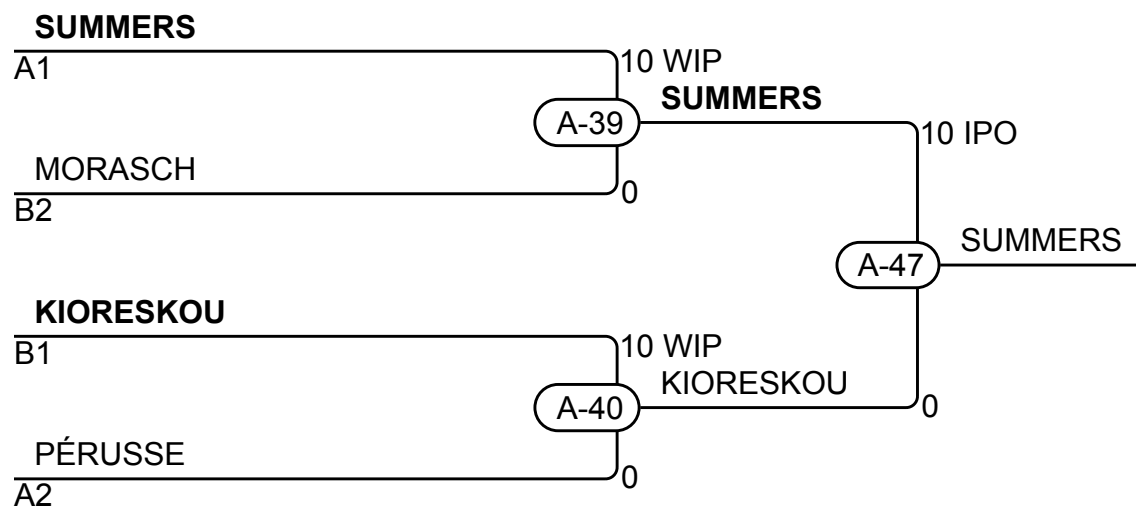

## Results/Résultats

Pos	Name/Nom
1	Victoria SUMMERS, Ajax Budokan
2	Angelina KIORESKOU, Shin Bu Kan (ON)
3	Finley MORASCH, Lethbridge
3	Juliette PÉRUSSE, Sakura (QC)

# U16 Female -70kg

## Competitors/Compétiteurs

#	Name/Nom	Grade	Club	1	2	3	4	5	W/G	Pts	Pos
1	Silesitiale CHAMBERS	Green	Sheffield	XX					0	0	5
2	Azra BENIC	Green	Saskatoon Y	10	XX				1	10	4
3	Emiliya ALIYEVA	Blue	Hiro's	10	10	XX	10	10	4	40	1
4	Malak AZAR	Green	Shidokan	10	10		XX	10	3	30	2
5	Abby LAVOIE	Blue	Seikidokan (QC)	10	10			XX	2	20	3

## Matches/Matches

Match	White/Blanc			Blue/Bleu	Res/Rés	Tim/Tmp	Code
C-4	<b>Malak AZAR</b>	4	5	Abby LAVOIE	10 - 0	0:40	WIP
C-5	Silesitiale CHAMBERS	1	2	<b>Azra BENIC</b>	0 - 10	1:43	IPO
C-10	<b>Emiliya ALIYEVA</b>	3	4	Malak AZAR	10 - 0	0:58	IPO
C-11	Silesitiale CHAMBERS	1	5	<b>Abby LAVOIE</b>	0 - 10	1:39	IPO
C-22	Azra BENIC	2	3	<b>Emiliya ALIYEVA</b>	0 - 10	0:20	IPO
C-23	Silesitiale CHAMBERS	1	4	<b>Malak AZAR</b>	0 - 10	0:10	IPO
C-37	<b>Emiliya ALIYEVA</b>	3	5	Abby LAVOIE	10 - 0	1:08	IPO
C-38	Azra BENIC	2	4	<b>Malak AZAR</b>	0 - 10	0:16	IPO
C-47	Silesitiale CHAMBERS	1	3	<b>Emiliya ALIYEVA</b>	0 - 10	0:53	IPO
C-48	Azra BENIC	2	5	<b>Abby LAVOIE</b>	0 - 10	2:01	IPO

## Results/Résultats

Pos	Name/Nom
1	Emiliya ALIYEVA, Hiro's
2	Malak AZAR, Shidokan
3	Abby LAVOIE, Seikidokan (QC)
4	Azra BENIC, Saskatoon Y

# U16 Male -38kg

## Competitors/Compétiteurs A

#	Name/Nom	Grade	Club	1	2	3	4	W/G	Pts	Pos
1	Grayden DIOME	Green	Tritton	XX	10			1	10	2
2	Grayson TAMURA	Green	Lethbridge		XX	10		1	10	3
3	Tikhon PETROCHENKOV	Green	Taifu	5		XX		1	5	4
4	Giorgi KURASHVILI	Green	Olympic	10	10	10	XX	3	30	1

## Pool A

Match	White/Blanc	Blue/Bleu	Res/Rés	Tim/Tmp	Code
E-5	<b>Grayden DIOME</b>	1 2 Grayson TAMURA	10 - 0	0:29	IPO
E-12	Tikhon PETROCHENKOV	3 4 <b>Giorgi KURASHVILI</b>	0 - 10	0:20	IPO
E-25	Grayden DIOME	1 3 <b>Tikhon PETROCHENKOV</b>	0 - 5	5:34	GSW
E-26	Grayson TAMURA	2 4 <b>Giorgi KURASHVILI</b>	0 - 10	1:35	IPO
E-37	Grayden DIOME	1 4 <b>Giorgi KURASHVILI</b>	0 - 10	1:14	WIP
E-38	<b>Grayson TAMURA</b>	2 3 Tikhon PETROCHENKOV	10 - 0	1:52	IPO

## Competitors/Compétiteurs B

#	Name/Nom	Grade	Club	5	6	7	W/G	Pts	Pos
5	Prokhor RESHETNIKOV	Green	Taifu	XX	5	10	2	15	1
6	Sergei BALANDIN	Green	Formokan		XX		0	0	3
7	Alexander LI	Green	Ippon		10	XX	1	10	2

## Pool B

Match	White/Blanc	Blue/Bleu	Res/Rés	Tim/Tmp	Code
E-15	<b>Prokhor RESHETNIKOV</b>	5 6 Sergei BALANDIN	5 - 0	3:00	WAZ
E-27	<b>Prokhor RESHETNIKOV</b>	5 7 Alexander LI	10 - 0	1:41	IPO
E-39	Sergei BALANDIN	6 7 <b>Alexander LI</b>	0 - 10	1:11	HAN

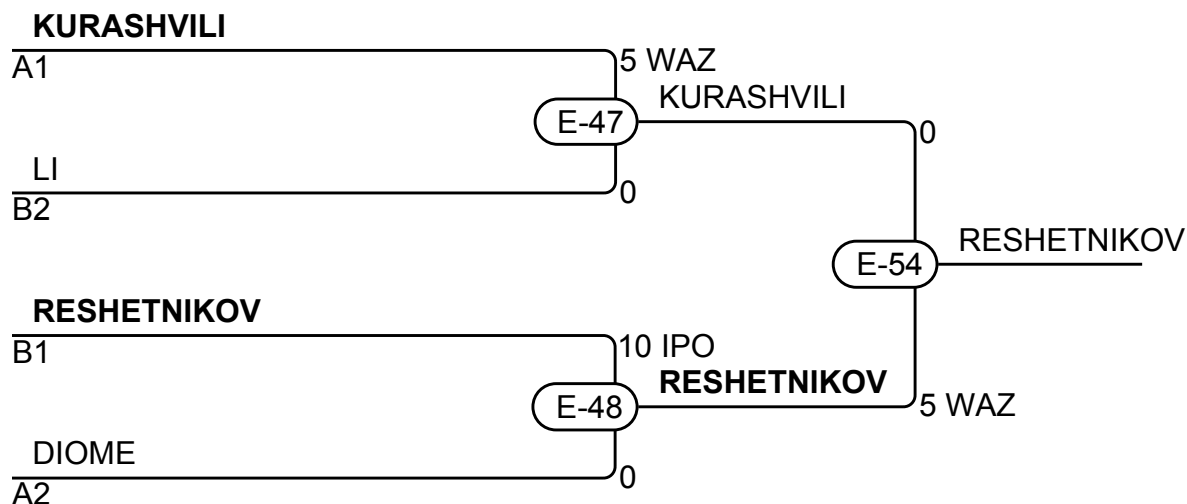

## Results/Résultats

Pos	Name/Nom
1	Prokhor RESHETNIKOV, Taifu
2	Giorgi KURASHVILI, Olympic
3	Alexander LI, Ippon
3	Grayden DIOME, Tritton

# U16 Male -42kg

## Competitors/Compétiteurs A

#	Name/Nom	Grade	Club	1	2	3	W/G	Pts	Pos
1	Rocco COBO	Blue	Hiro's	XX		10	1	10	2
2	Oleksander SMAKULA	Green	Ippon	10	XX	10	2	20	1
3	Felix LEONARD	Green	Moose Jaw			XX	0	0	3

## Pool A

Match	White/Blanc			Blue/Bleu	Res/Rés	Tim/Tmp	Code
C-31	Rocco COBO	1	2	Oleksander SMAKULA	0 - 10	2:01	IPO
C-45	Rocco COBO	1	3	Felix LEONARD	10 - 0	7:26	HAN
C-51	Oleksander SMAKULA	2	3	Felix LEONARD	10 - 0	0:00	IPO

## Competitors/Compétiteurs B

#	Name/Nom	Grade	Club	4	5	6	W/G	Pts	Pos
4	Dumitru SANDU	Green	Ishi Yama	XX			0	0	3
5	Gabrieli MAKHATADZE	Green	Olympic	10	XX	5	2	15	1
6	Ewen LE BRIS	Blue	Peak Judo Club	10		XX	1	10	2

## Pool B

Match	White/Blanc			Blue/Bleu	Res/Rés	Tim/Tmp	Code
C-32	Dumitru SANDU	4	5	Gabrieli MAKHATADZE	0 - 10	0:11	IPO
C-46	Dumitru SANDU	4	6	Ewen LE BRIS	0 - 10	1:44	IPO
C-52	Gabrieli MAKHATADZE	5	6	Ewen LE BRIS	5 - 0	3:00	WAZ

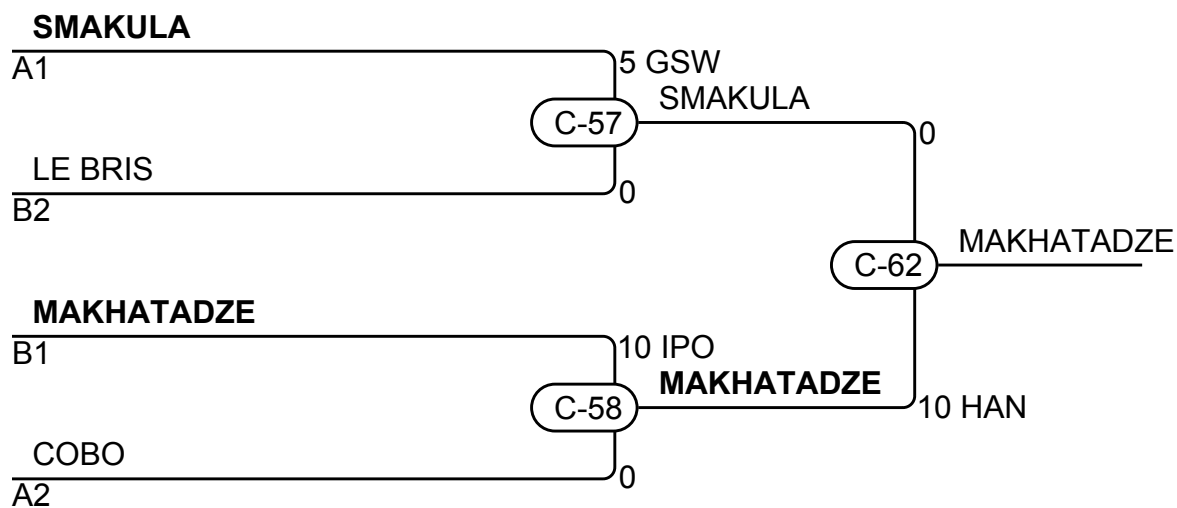

## Results/Résultats

Pos	Name/Nom
1	Gabrieli MAKHATADZE, Olympic
2	Oleksander SMAKULA, Ippon
3	Ewen LE BRIS, Peak Judo Club
3	Rocco COBO, Hiro's

# U16 Male -46kg

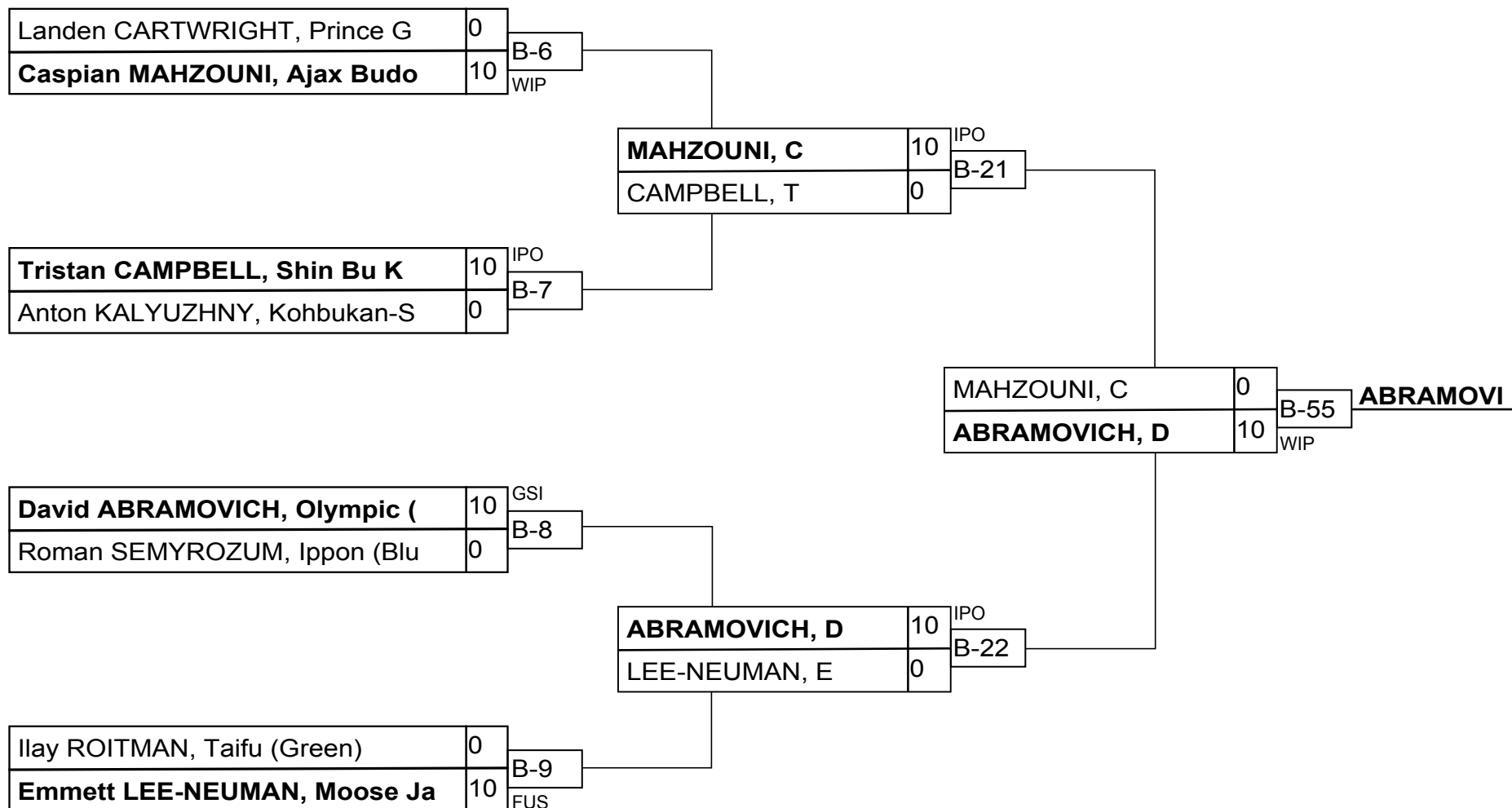

## Results/Résultats

Pos	Name/Nom
1	David ABRAMOVICH, Olympi
2	Caspian MAHZOUNI, Ajax B
3	Roman SEMYROZUM, Ippon (
3	Emmett LEE-NEUMAN, Moose

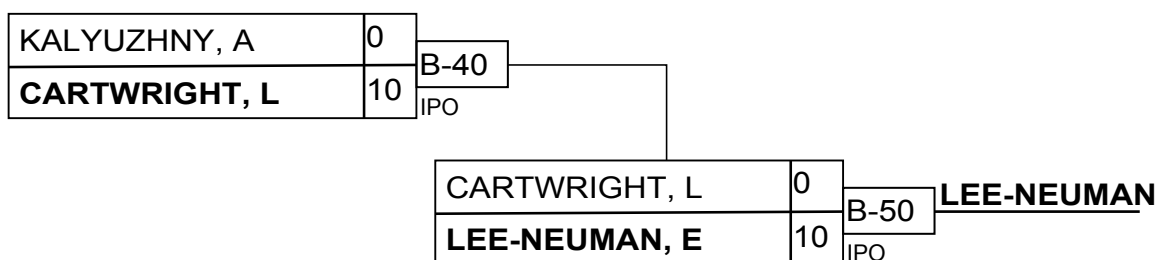
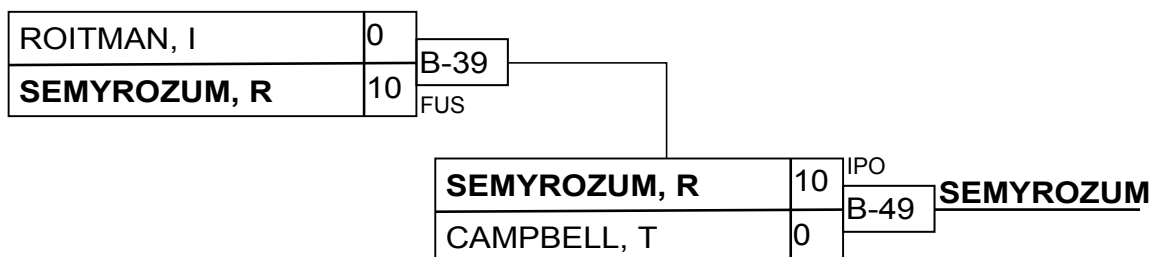

# U16 Male -50kg

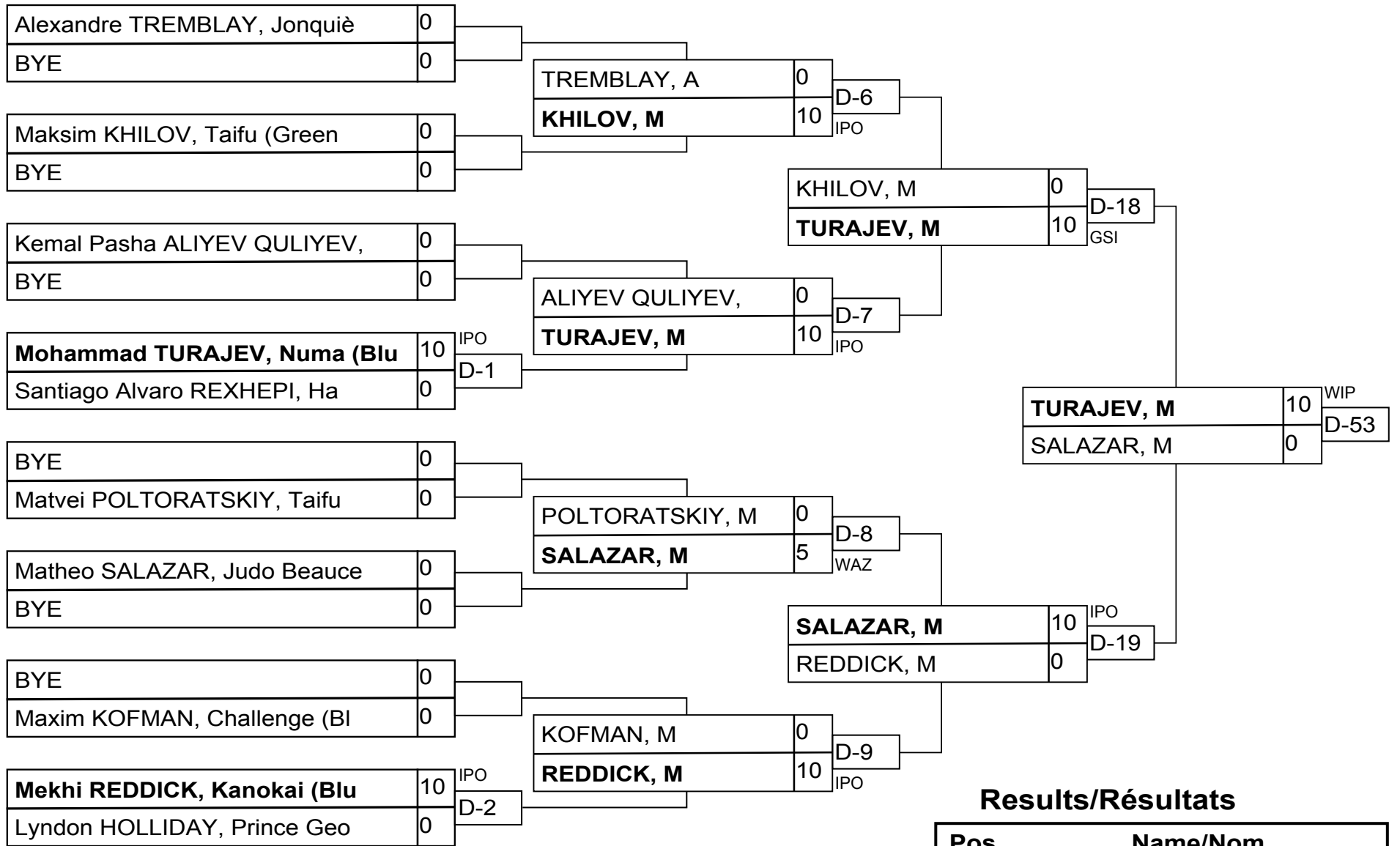

## Results/Résultats

Pos	Name/Nom
1	Mohammad TURAJEV, Numa (
2	Matheo SALAZAR, Judo Bea
3	Matvei POLTORATSKIY, Tai
3	Kemal Pasha ALIYEV QULIY

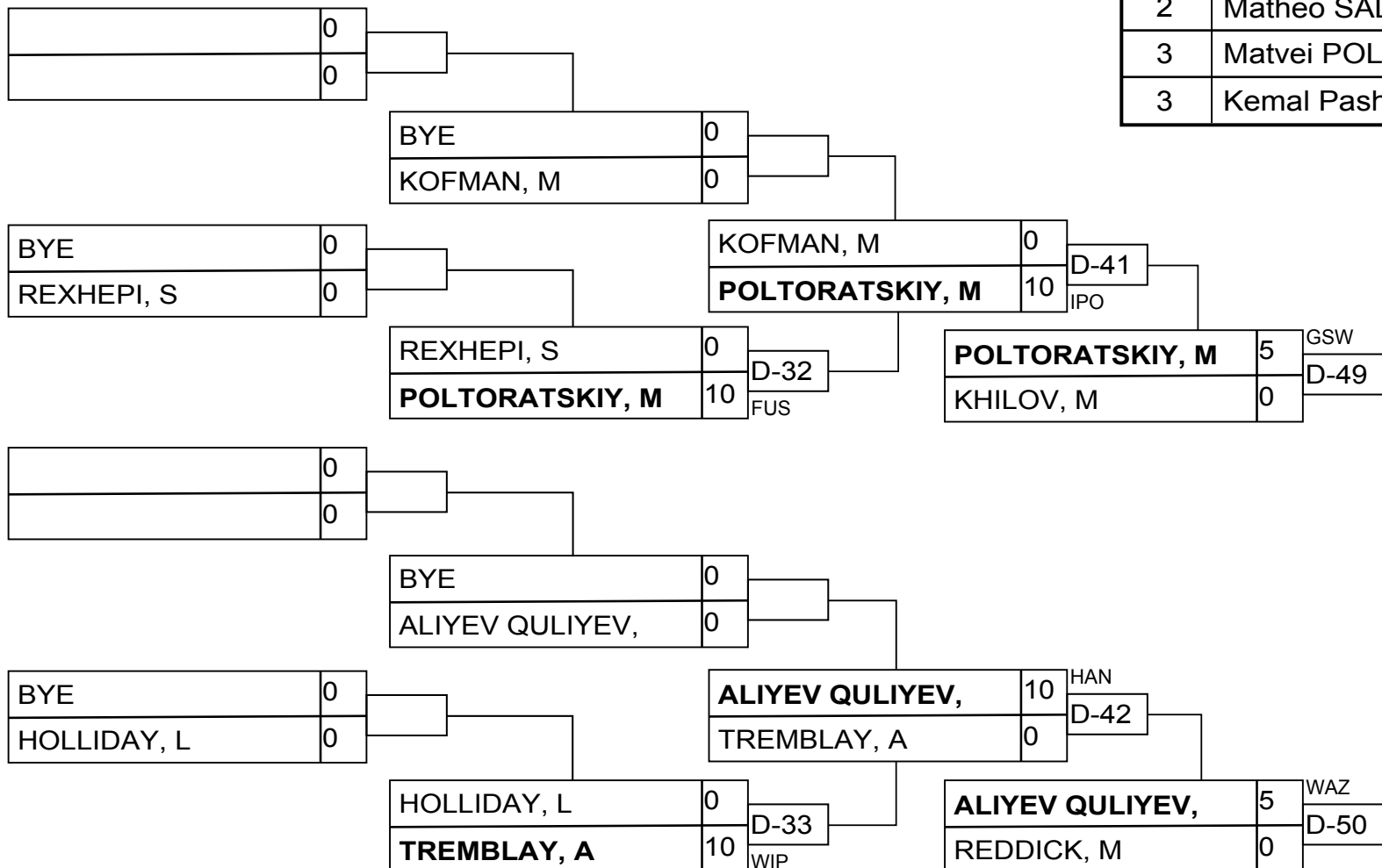

# U16 Male -55kg

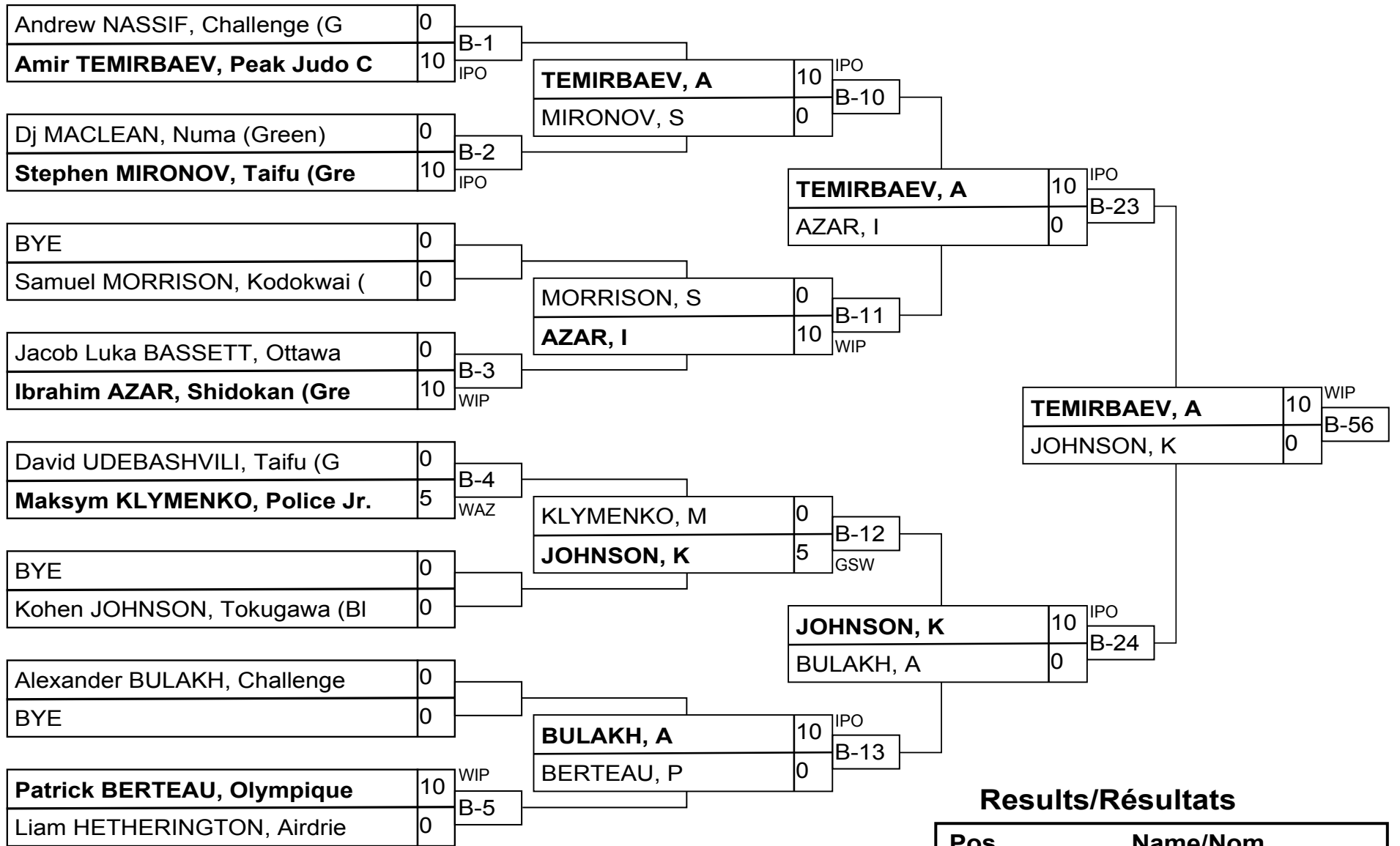

## Results/Résultats

Pos	Name/Nom
1	Amir TEMIRBAEV, Peak Jud
2	Kohen JOHNSON, Tokugawa
3	Maksym KLYMENKO, Police
3	Alexander BULAKH, Challe

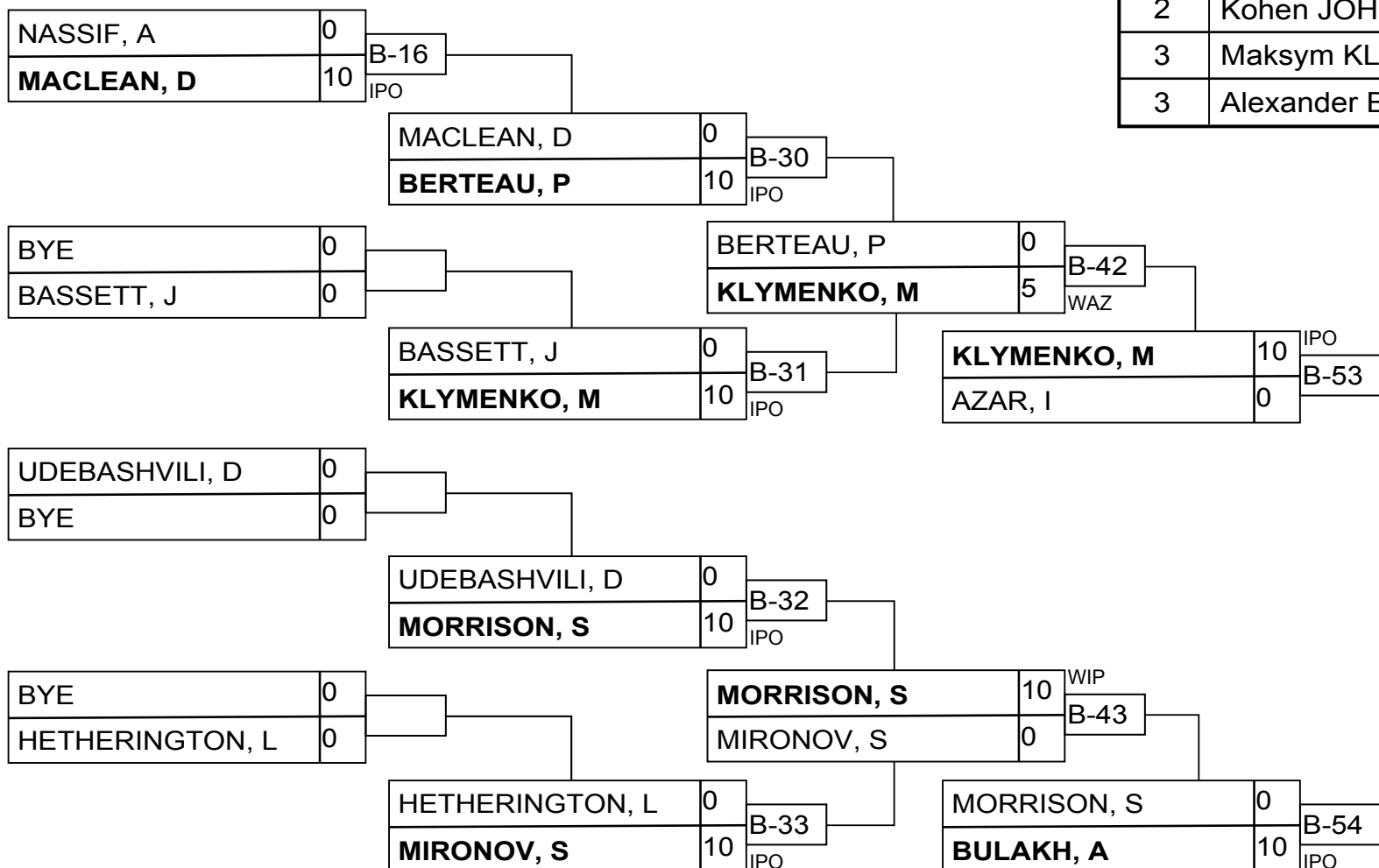



# U16 Male -60kg

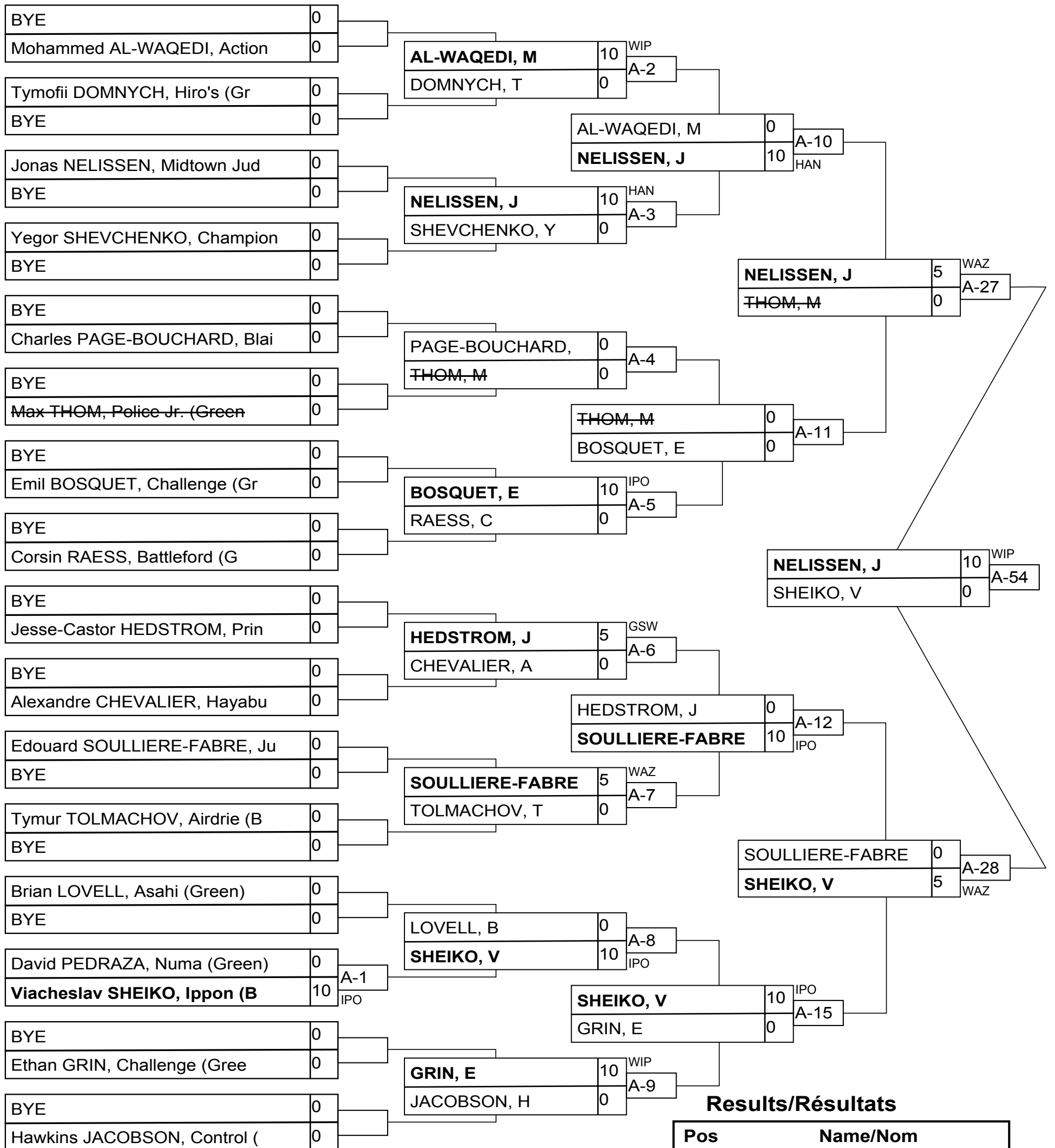

# U16 Male -60kg

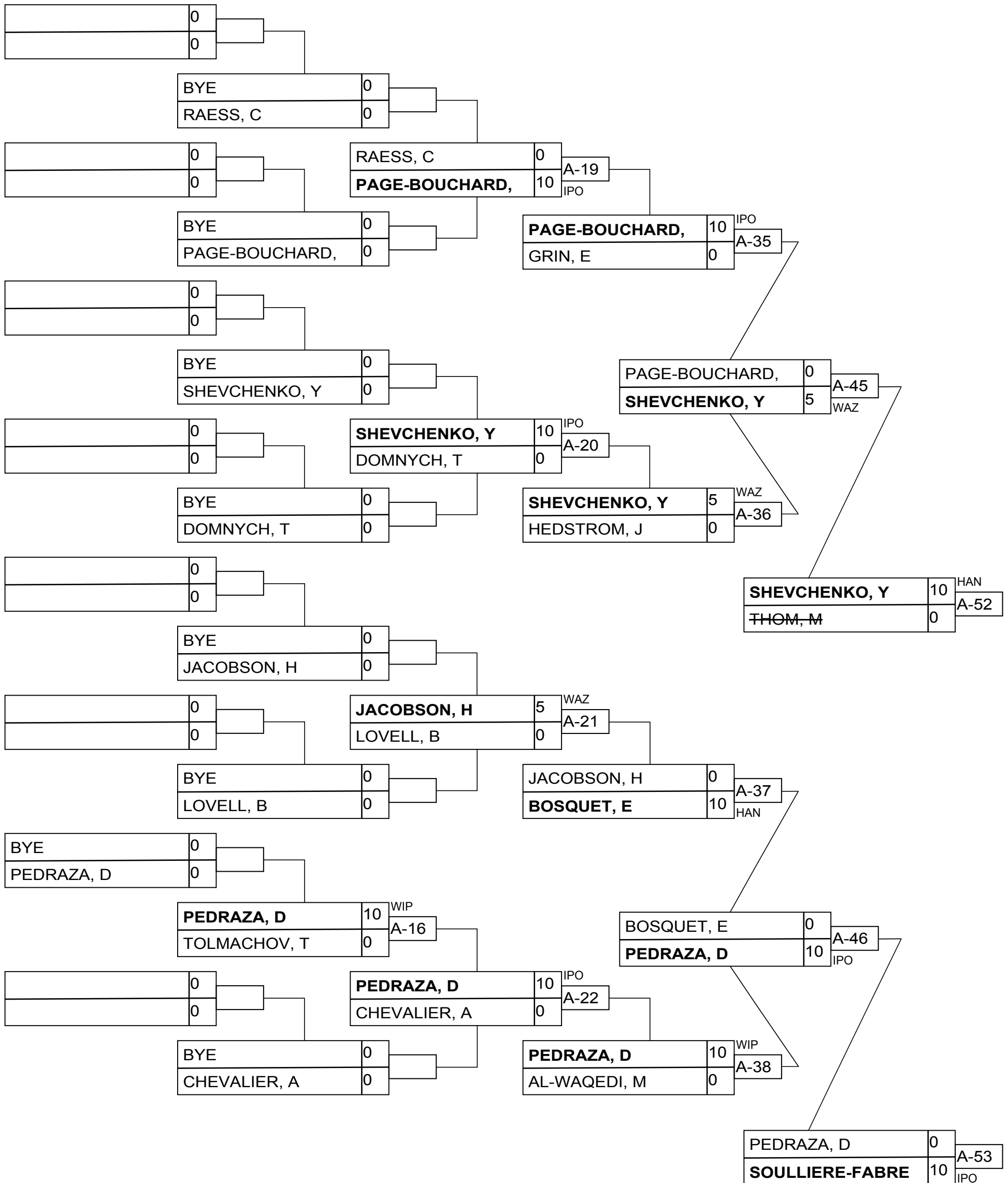

# U16 Male -66kg

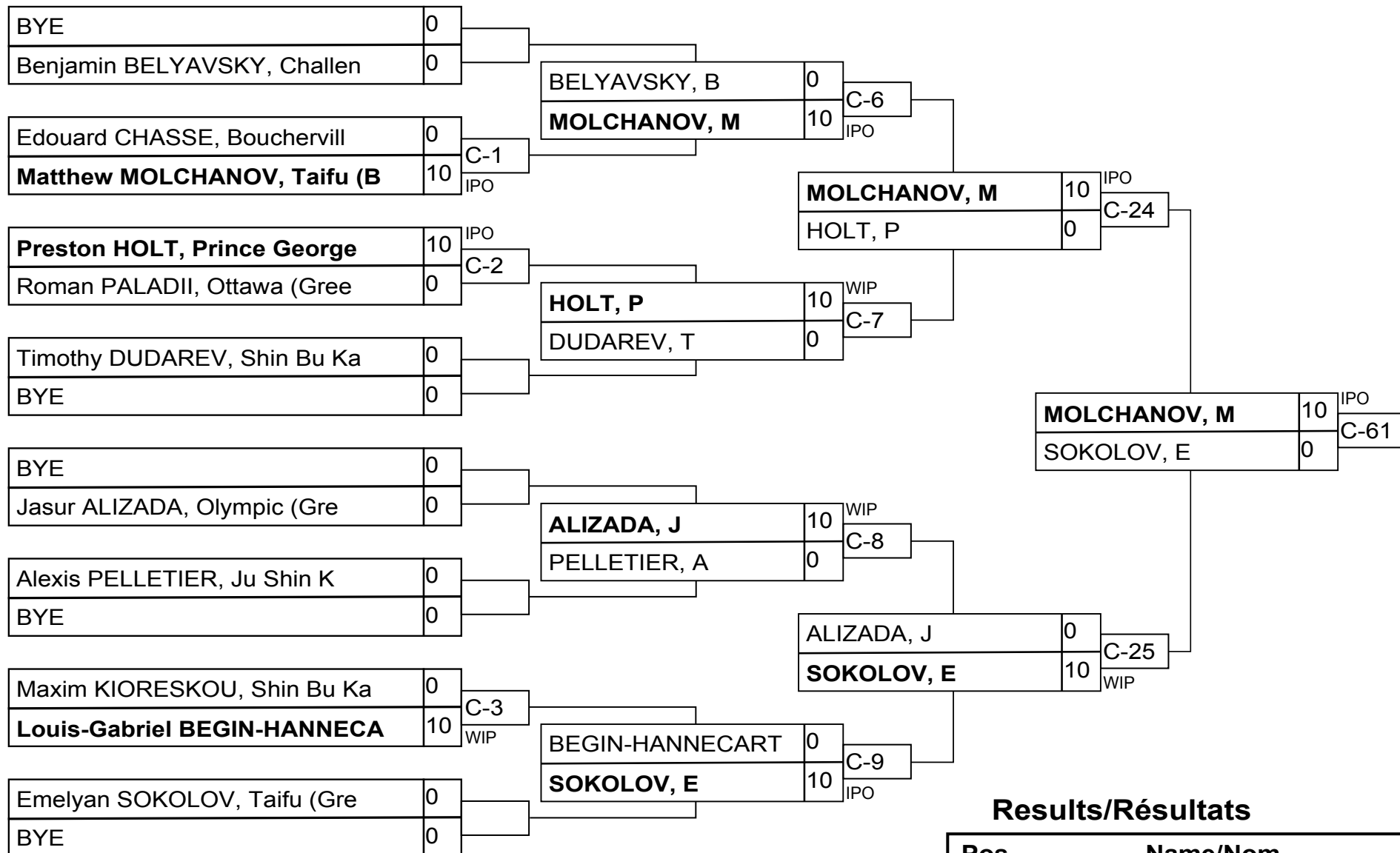

## Results/Résultats

Pos	Name/Nom
1	Matthew MOLCHANOV, Taifu
2	Emelyan SOKOLOV, Taifu (
3	Edouard CHASSE, Boucherv
3	Jasur ALIZADA, Olympic (

BYE	0
CHASSE, E	0

CHASSE, E	10	IPO
BEGIN-HANNECART	0	C-40

PALADII, R	0
BYE	0

CHASSE, E	10	IPO
PALADII, R	0	C-49

PALADII, R	10	IPO
PELLETIER, A	0	C-41

CHASSE, E	10	IPO
HOLT, P	0	C-55

	0
	0

BYE	0
DUDAREV, T	0

KIORESKOU, M	0
BYE	0

DUDAREV, T	0	
KIORESKOU, M	10	IPO

KIORESKOU, M	10	IPO
BELYAVSKY, B	0	C-42

KIORESKOU, M	0	C-56
ALIZADA, J	10	GSI

# U16 Male -73kg

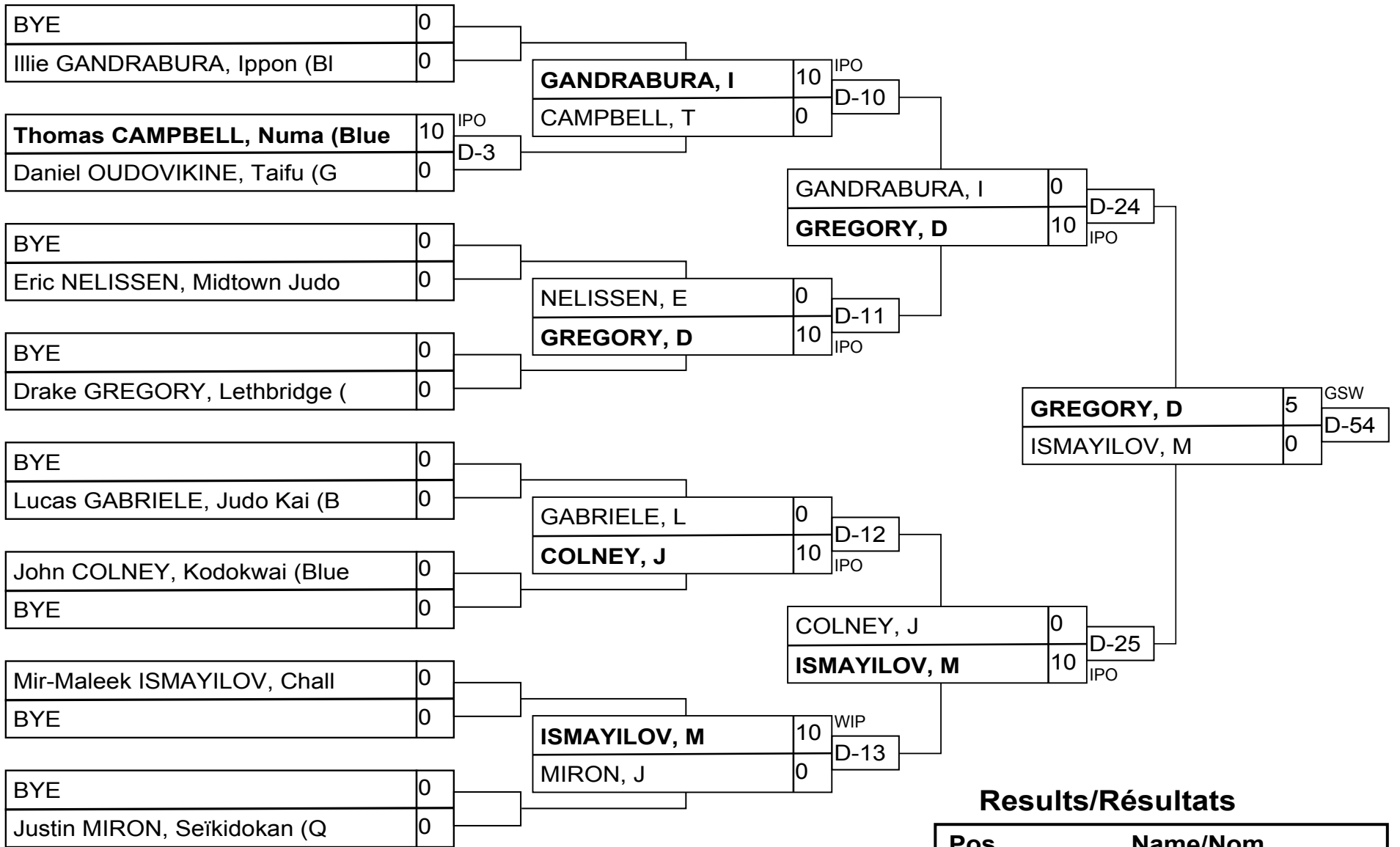

## Results/Résultats

Pos	Name/Nom
1	Drake GREGORY, Lethbridg
2	Mir-Maleek ISMAYILOV, Ch
3	Illie GANDRABURA, Ippon
3	Thomas CAMPBELL, Numa (B)

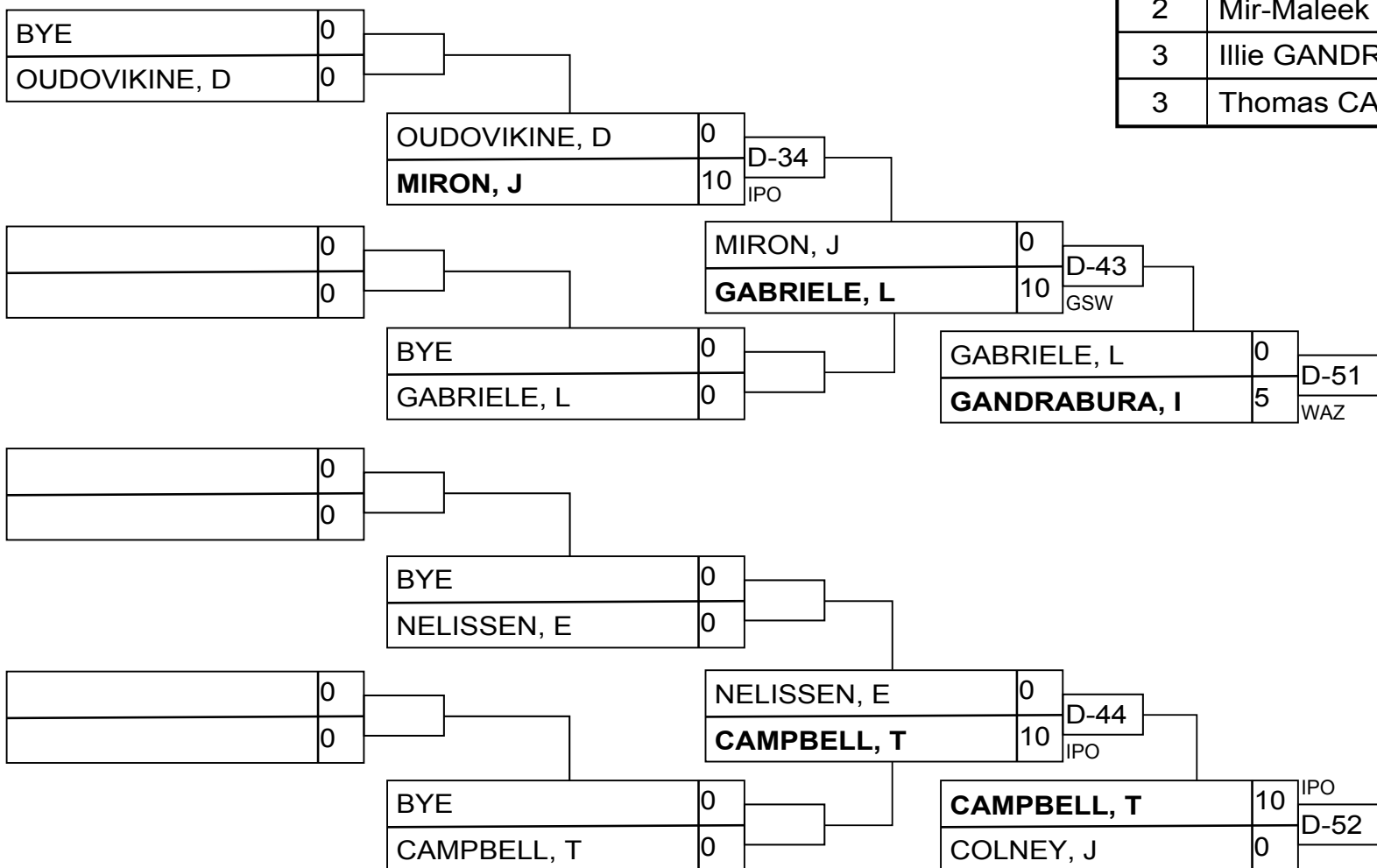

# U16 Male +73kg

## Competitors/Compétiteurs A

#	Name/Nom	Grade	Club	1	2	3	W/G	Pts	Pos
1	Taha SAFAEIMEHR	Green	Olympic	XX			0	0	3
2	Andrew MAHEUX-DYER	Blue	Beauport	10	XX	10	2	20	1
3	Ridley SUBERLAK	Green	Battleford	10		XX	1	10	2

## Pool A

Match	White/Blanc	Blue/Bleu	Res/Rés	Tim/Tmp	Code
B-18	Taha SAFAEIMEHR 1 2	Andrew MAHEUX-DYER	0 - 10	0:56	WIP
B-34	Taha SAFAEIMEHR 1 3	Ridley SUBERLAK	0 - 10	3:11	HAN
B-44	Andrew MAHEUX-DYER 2 3	Ridley SUBERLAK	10 - 0	1:39	IPO

## Competitors/Compétiteurs B

#	Name/Nom	Grade	Club	4	5	6	W/G	Pts	Pos
4	Zain CHAUDHRY	Green	Challenge	XX	10	10	2	20	1
5	Franck David MOUSSIMA EWAN	Green	Ippon		XX	10	1	10	2
6	Owen BILODEAU	Green	Numa			XX	0	0	3

## Pool B

Match	White/Blanc	Blue/Bleu	Res/Rés	Tim/Tmp	Code
B-25	Zain CHAUDHRY 4 5	Franck David MOUSSIMA EWANE ELOUTI	10 - 0	1:08	IPO
B-35	Zain CHAUDHRY 4 6	Owen BILODEAU	10 - 0	1:41	IPO
B-45	Franck David MOUSSIMA EWANE ELOUTI 5 6	Owen BILODEAU	10 - 0	0:16	IPO

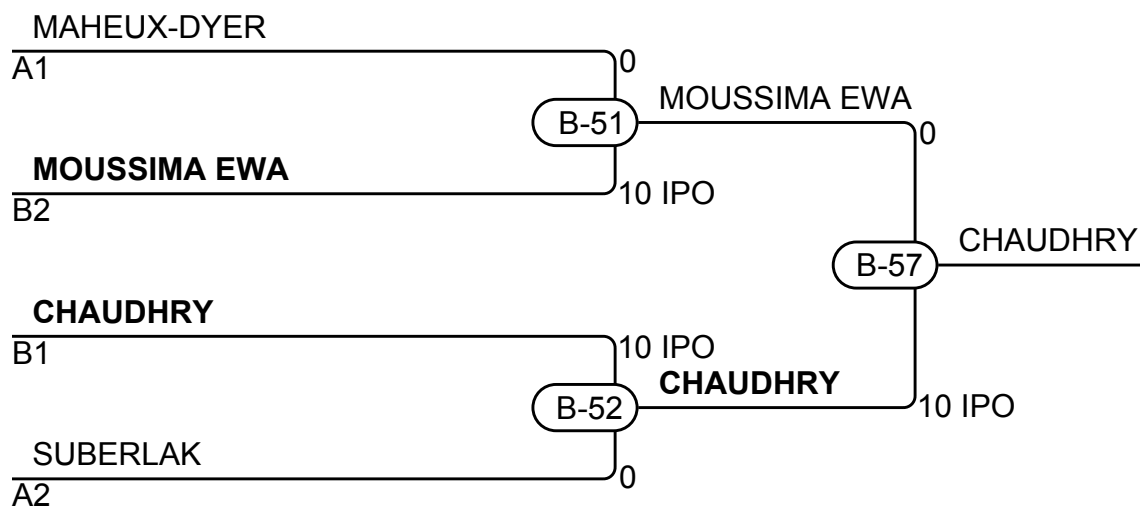

## Results/Résultats

Pos	Name/Nom
1	Zain CHAUDHRY, Challenge
2	Franck David MOUSSIMA EWANE ELOUTI, Ippon
3	Andrew MAHEUX-DYER, Beauport
3	Ridley SUBERLAK, Battleford