

U16F -40kg

Compétiteurs/Competitors

#	Nom/Name	Grade	Club	1	2	3	4	G/W	Pts	Pos
1	Maryloo HOGAN	3k	QC	XX				0	0	4
2	Maya ROY	3k	QC	10	XX	10	10	3	30	1
3	Abigail MCMAHON	3k	PE	10		XX		1	10	3
4	Marisol SAVOIE	3k	NB	10		10	XX	2	20	2

Matches/Matches

Match	Blanc/White			Bleu/Blue	Rés/Res	Tmp/Tim	Code
D-117	Maryloo HOGAN	1	2	Maya ROY	0 - 10	1:11	WIP
D-118	Abigail MCMAHON	3	4	Marisol SAVOIE	0 - 10	0:47	WIP
D-132	Maryloo HOGAN	1	3	Abigail MCMAHON	0 - 10	0:53	KIK
D-133	Maya ROY	2	4	Marisol SAVOIE	10 - 0	2:30	WIP
D-141	Maryloo HOGAN	1	4	Marisol SAVOIE	0 - 10	0:00	FUS
D-142	Maya ROY	2	3	Abigail MCMAHON	10 - 0	0:25	IPO

Résultats/Results

Pos	Nom/Name
1	Maya ROY, QC
2	Marisol SAVOIE, NB
3	Abigail MCMAHON, PE

U16F -48kg

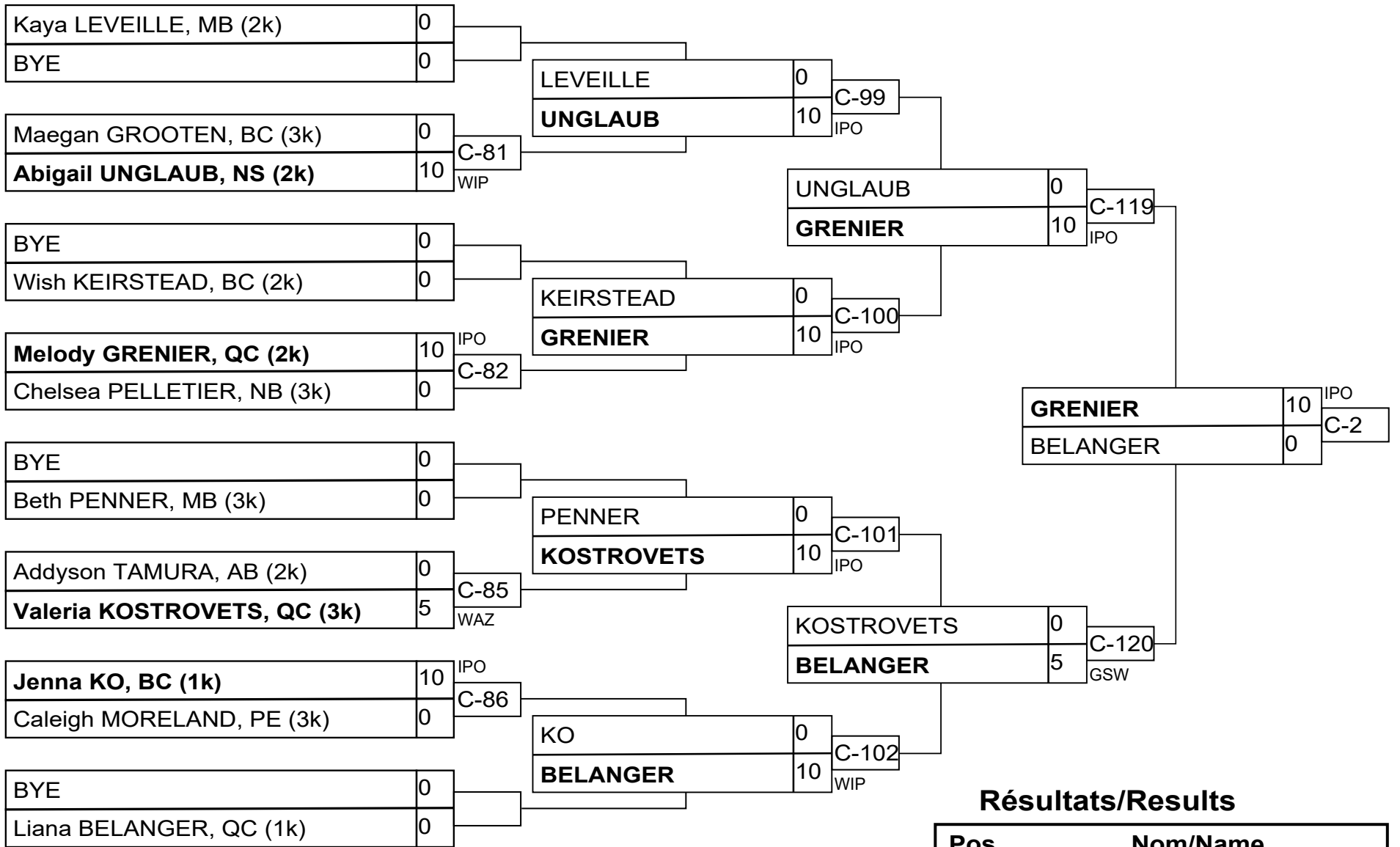

Résultats/Results

Pos	Nom/Name
1	Melody GRENIER, QC (2k)
2	Liana BELANGER, QC (1k)
3	Jenna KO, BC (1k)
3	Addyson TAMURA, AB (2k)

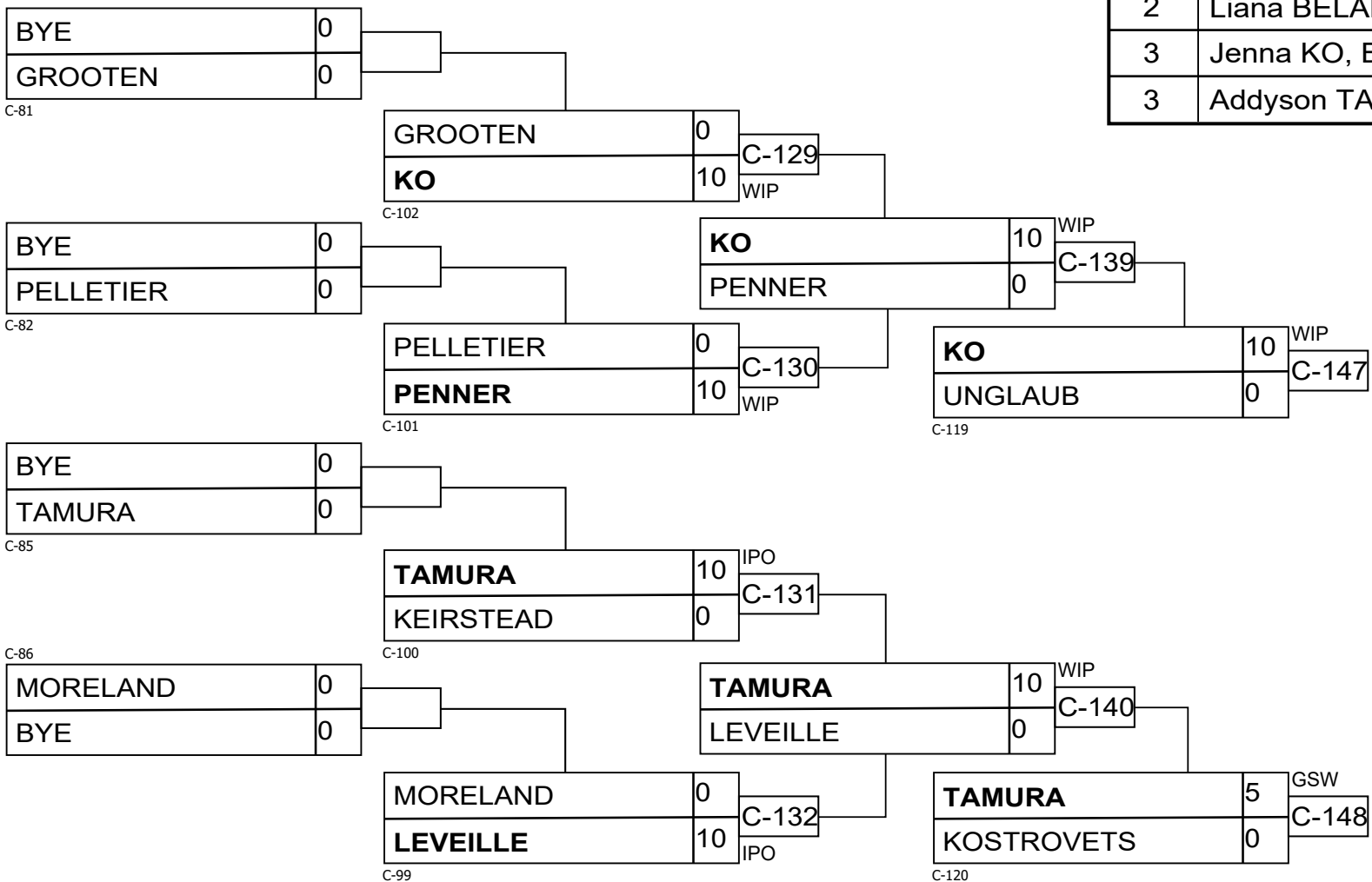

U16F -52kg

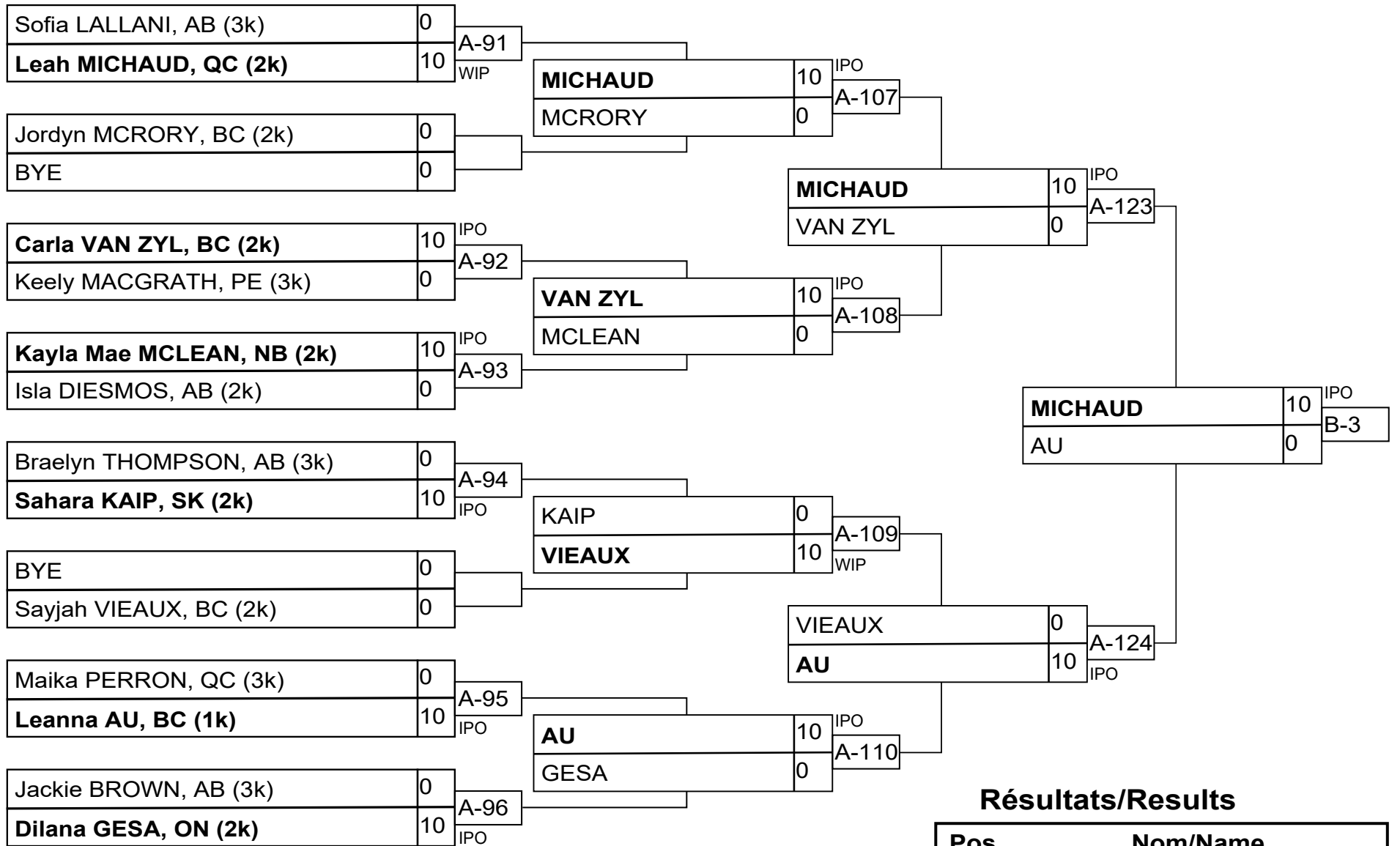

Résultats/Results

Pos	Nom/Name
1	Leah MICHAUD, QC (2k)
2	Leanna AU, BC (1k)
3	Isla DIESMOS, AB (2k)
3	Kayla Mae MCLEAN, NB (2k)

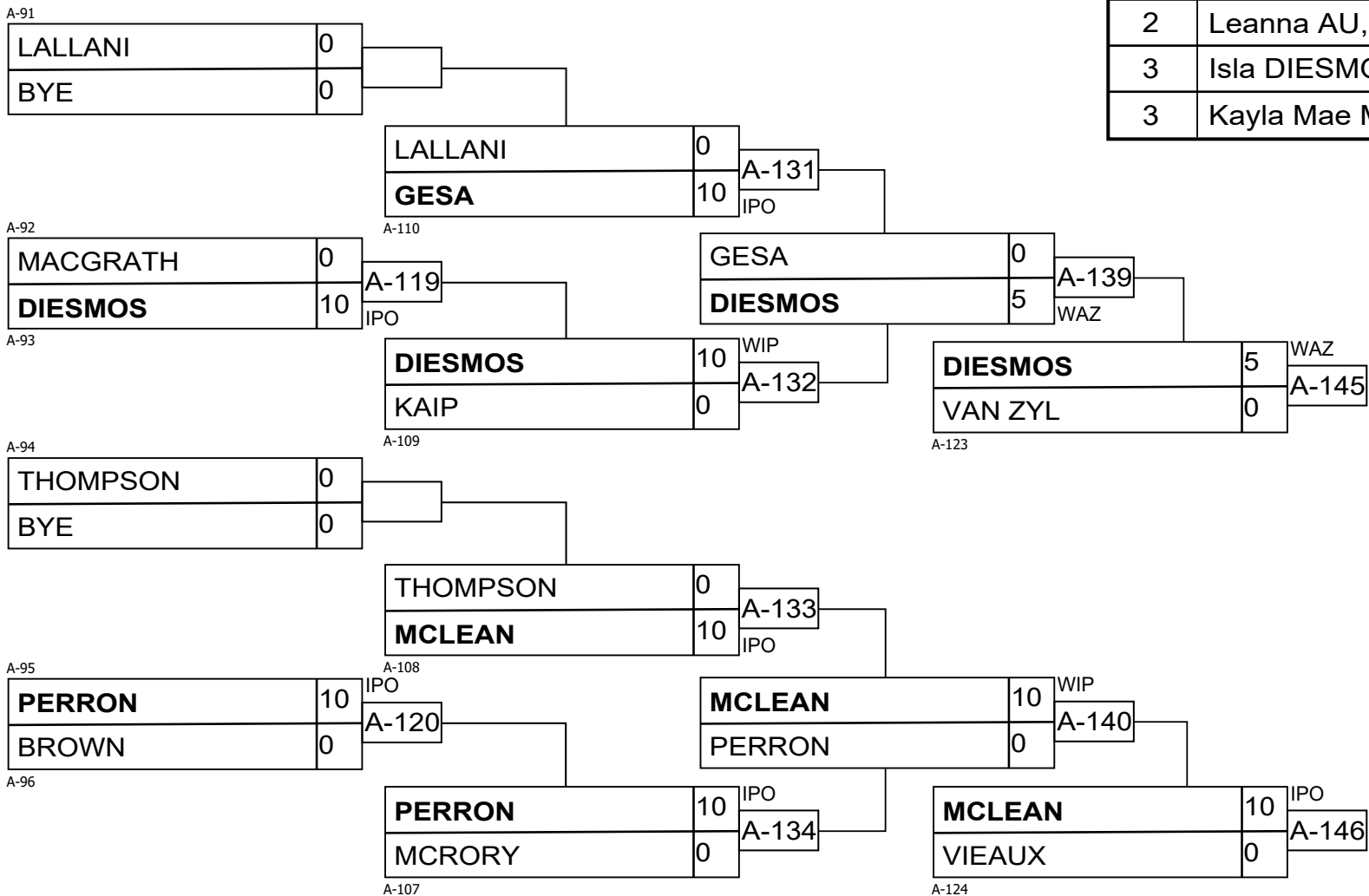

U16F -57kg

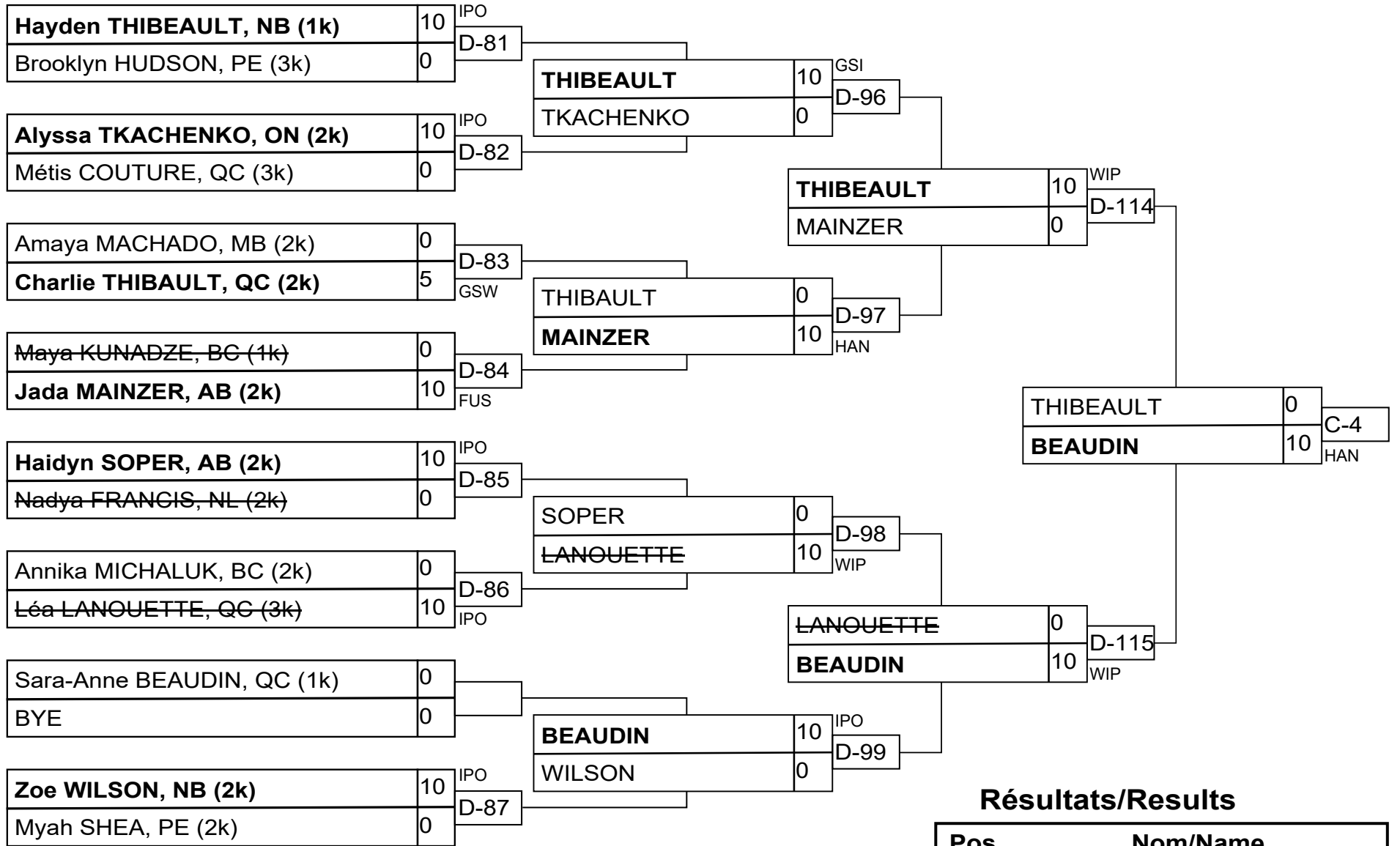

Résultats/Results

Pos	Nom/Name
1	Sara-Anne BEAUDIN, QC (1)
2	Hayden THIBEAULT, NB (1k)
3	Amaya MACHADO, MB (2k)
3	Alyssa TKACHENKO, ON (2k)

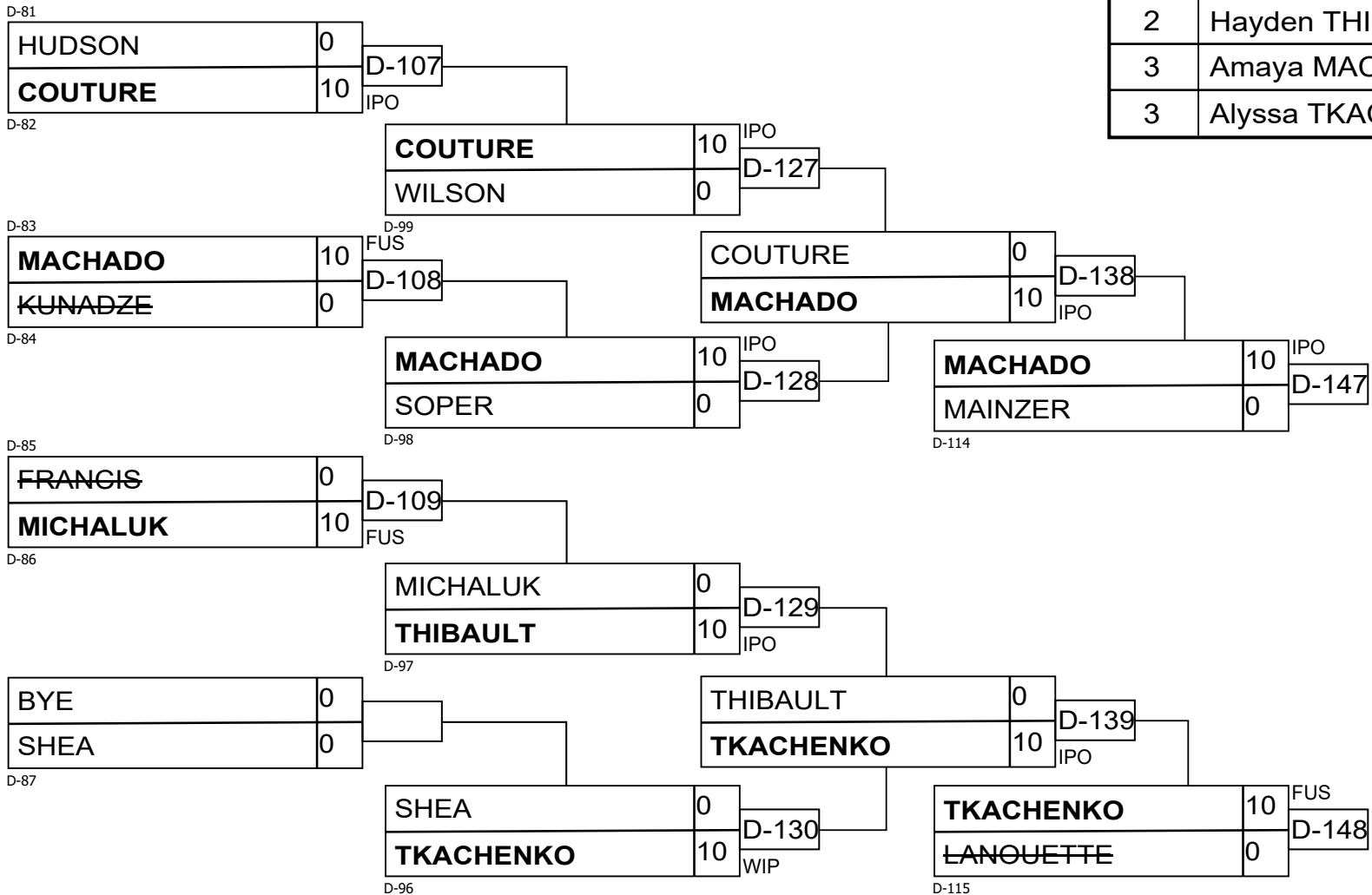

U16F -63kg

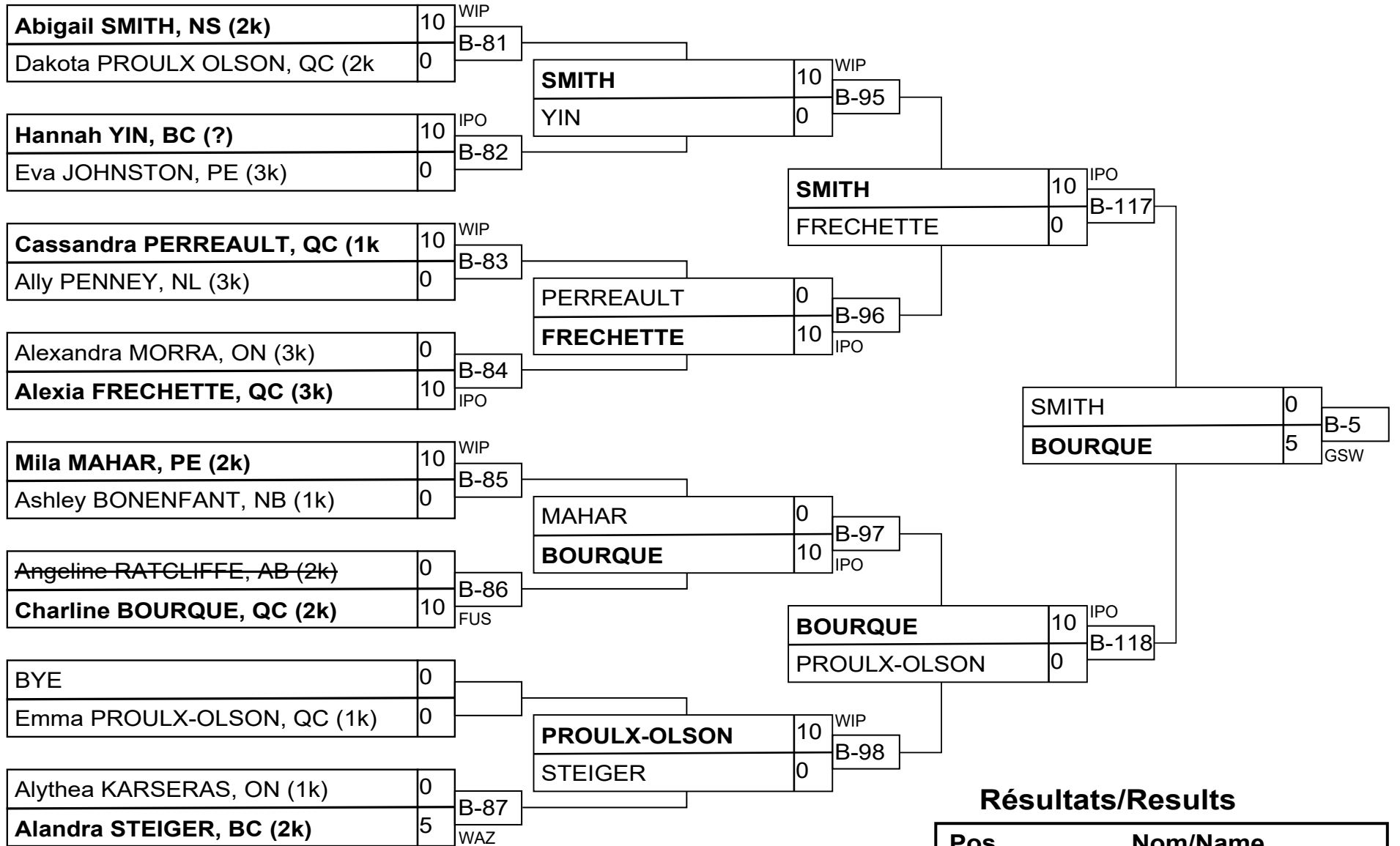

Résultats/Results

Pos	Nom/Name
1	Charline BOURQUE, QC (2k)
2	Abigail SMITH, NS (2k)
3	Alexia FRECHETTE, QC (3k)
3	Hannah YIN, BC (?)

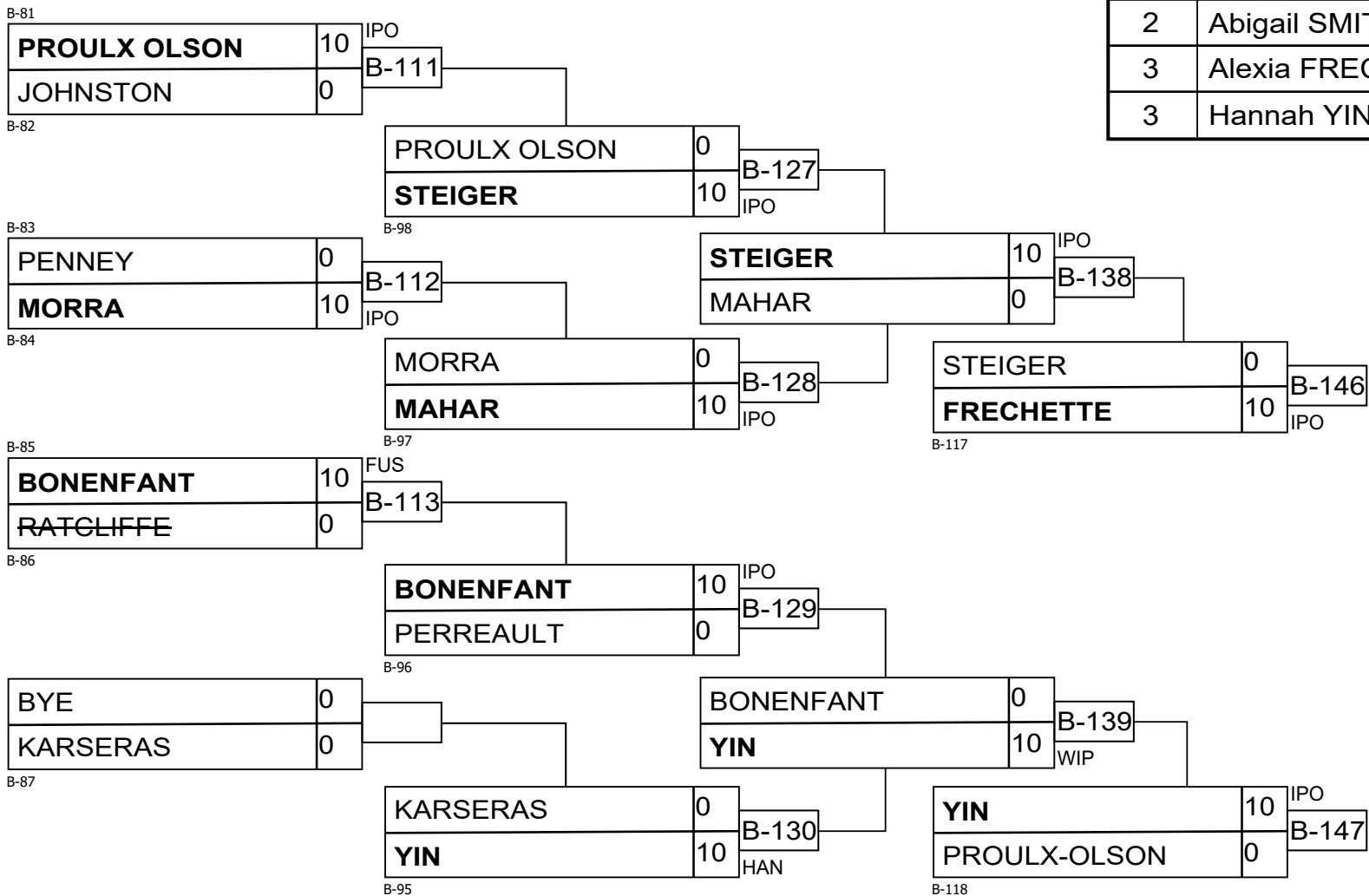

U16F -70kg

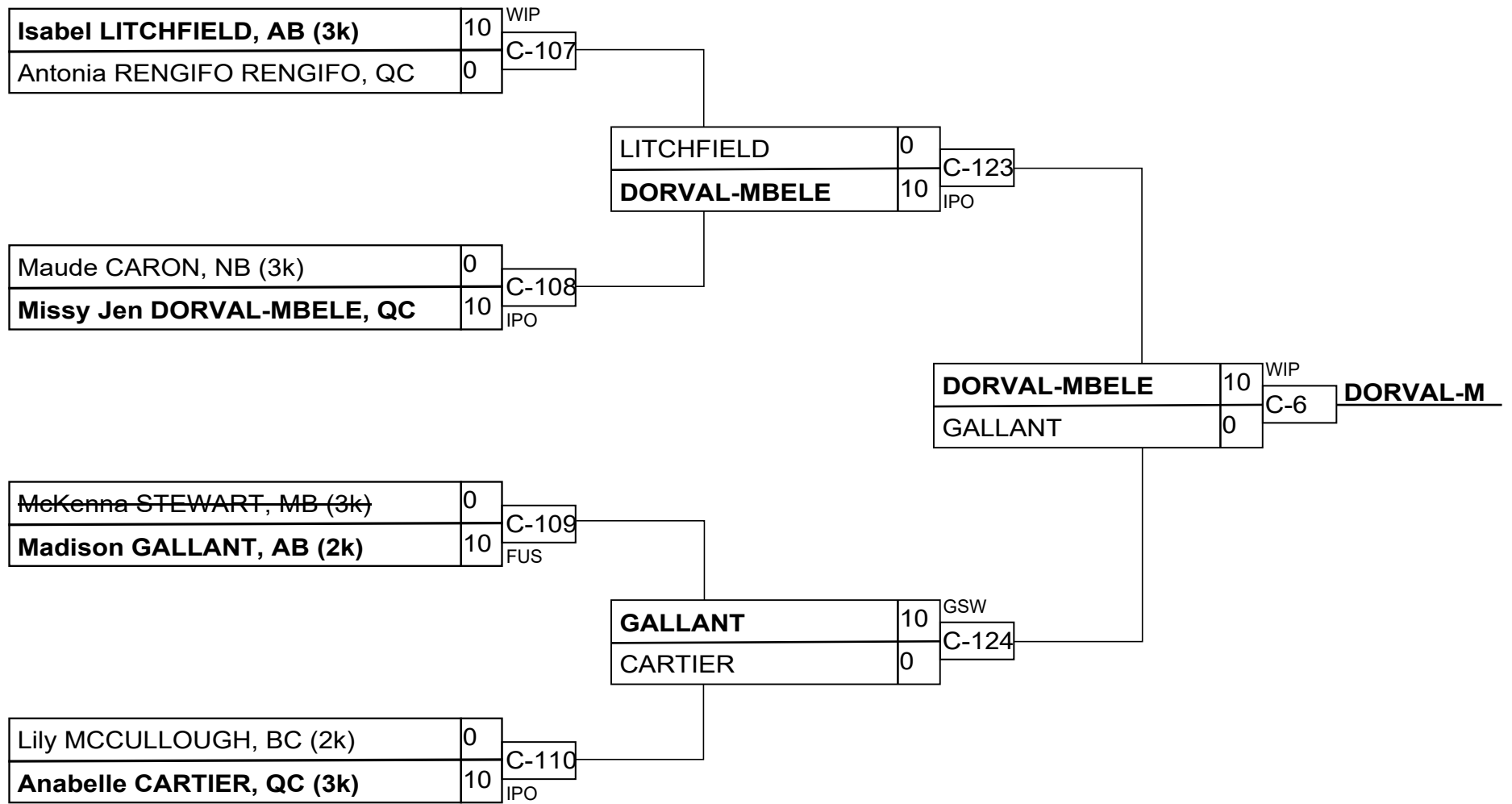

Résultats/Results

Pos	Nom/Name
1	Missy Jen DORVAL-MBELE,
2	Madison GALLANT, AB (2k)
3	Lily MCCULLOUGH, BC (2k)
3	Anabelle CARTIER, QC (3k)

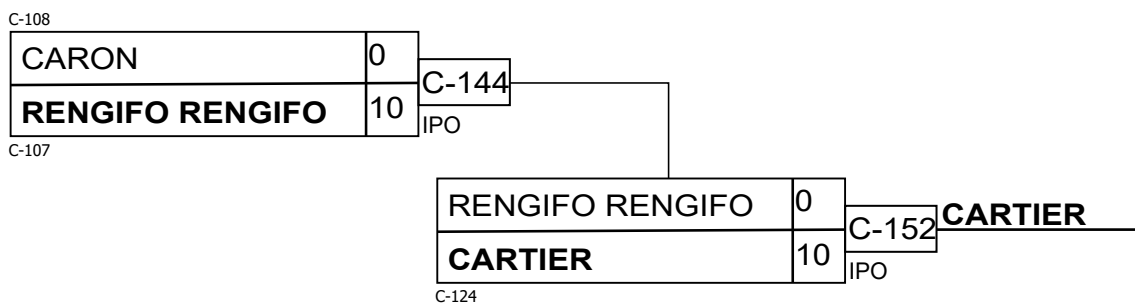
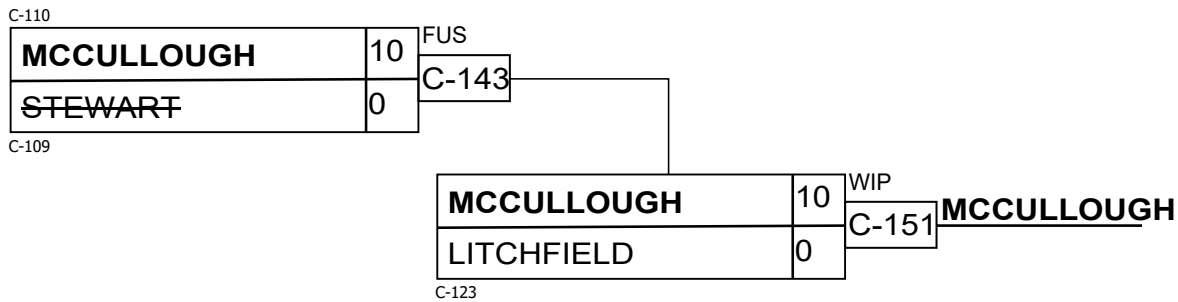

U16F +70kg

Compétiteurs/Competitors

#	Nom/Name	Grade	Club	1	2	3	G/W	Pts	Pos
1	Miguela NGOMBI	3k	QC	XX	10		1	10	2
2	Kathleen SIMMONDS	3k	NL		XX		0	0	3
3	Naomi FOWLER	2k	NB	10	10	XX	2	20	1

Matches/Matches

Match	Blanc/White			Bleu/Blue	Rés/Res	Tmp/Tim	Code
D-116	Miguela NGOMBI	1	2	Kathleen SIMMONDS	10 - 0	0:00	IPO
D-131	Miguela NGOMBI	1	3	Naomi FOWLER	0 - 10	0:51	WIP
D-140	Kathleen SIMMONDS	2	3	Naomi FOWLER	0 - 10	0:21	WIP

Résultats/Results

Pos	Nom/Name
1	Naomi FOWLER, NB
2	Miguela NGOMBI, QC

U16M -38kg

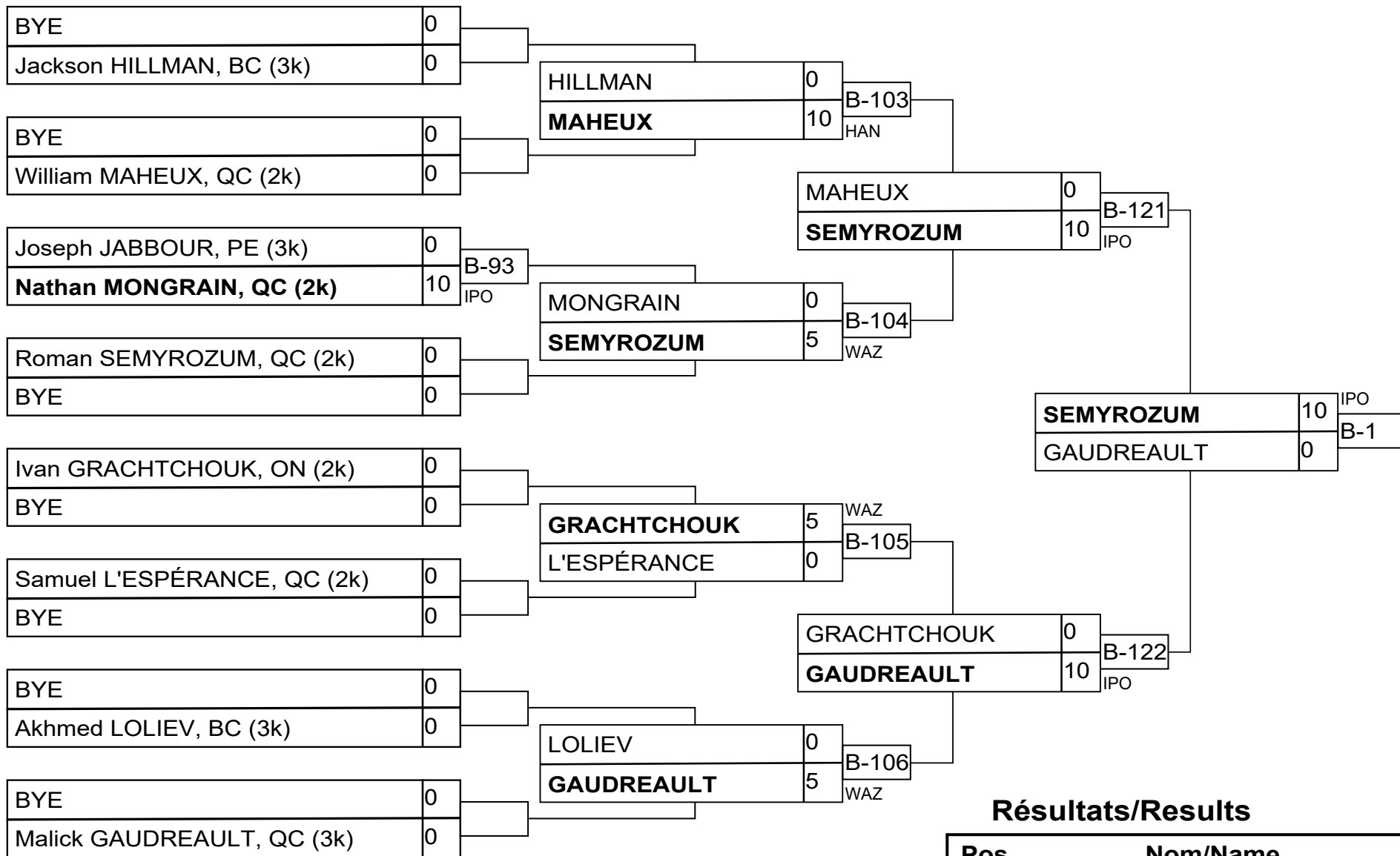

Résultats/Results

Pos	Nom/Name
1	Roman SEMYROZUM, QC (2k)
2	Malick GAUDREAULT, QC (3k)
3	Akhmed LOLIEV, BC (3k)
3	Ivan GRACHTCHOUK, ON (2k)

0
0

BYE	0
LOLIEV	0

JABBOUR	0
BYE	0

LOLIEV	10	IPO
L'ESPÉRANCE	0	B-142

JABBOUR	0	B-135
L'ESPÉRANCE	10	IPO

LOLIEV	10	IPO
MAHEUX	0	B-150

0
0

BYE	0
MONGRAIN	0

0
0

MONGRAIN	0	B-143
HILLMAN	10	HAN

BYE	0
HILLMAN	0

HILLMAN	0	B-151
GRACHTCHOUK	10	WIP

B-103

B-122

U16M -42kg

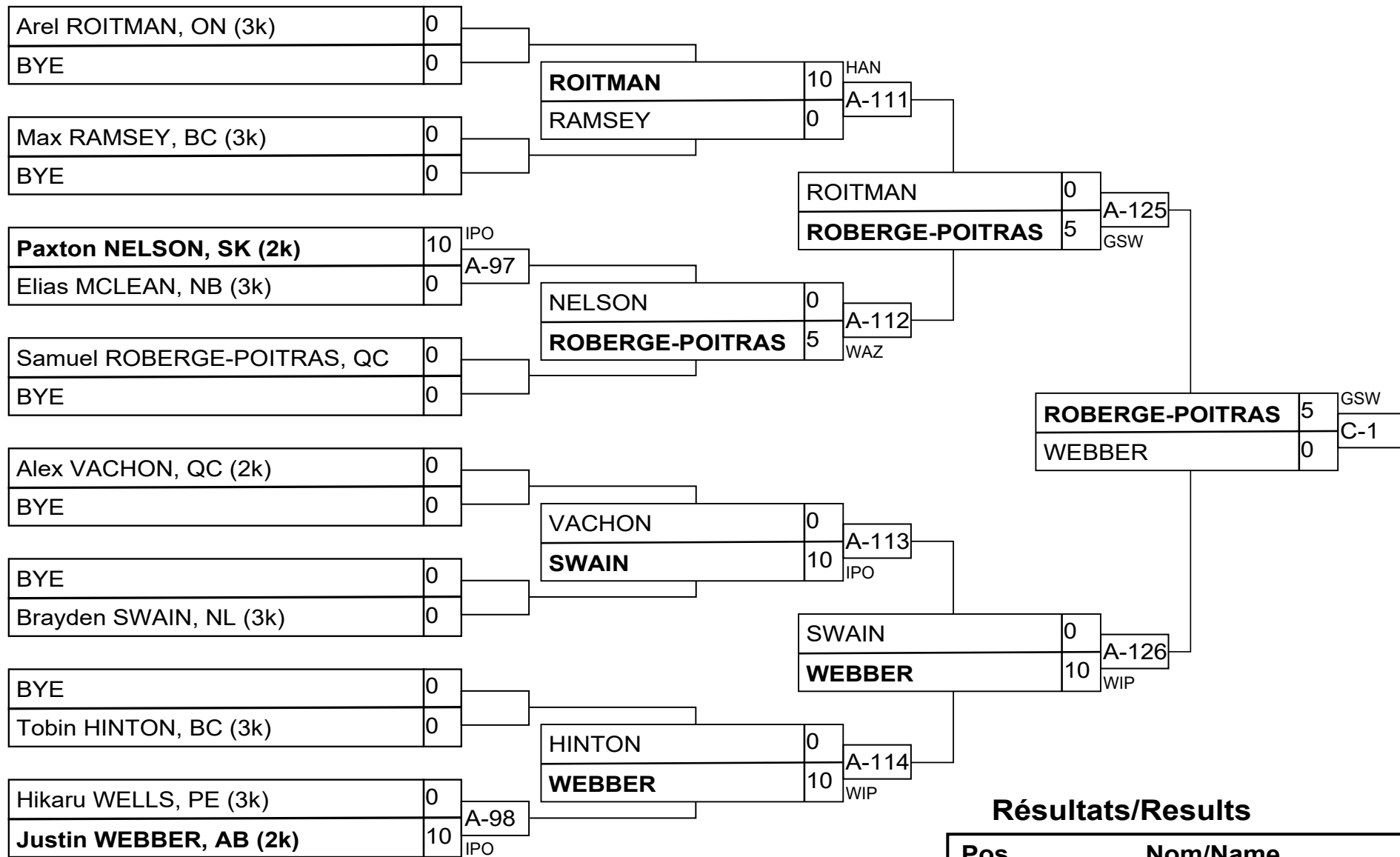

Résultats/Results

Pos	Nom/Name
1	Samuel ROBERGE-POITRAS,
2	Justin WEBBER, AB (2k)
3	Arel ROITMAN, ON (3k)
3	Paxton NELSON, SK (2k)

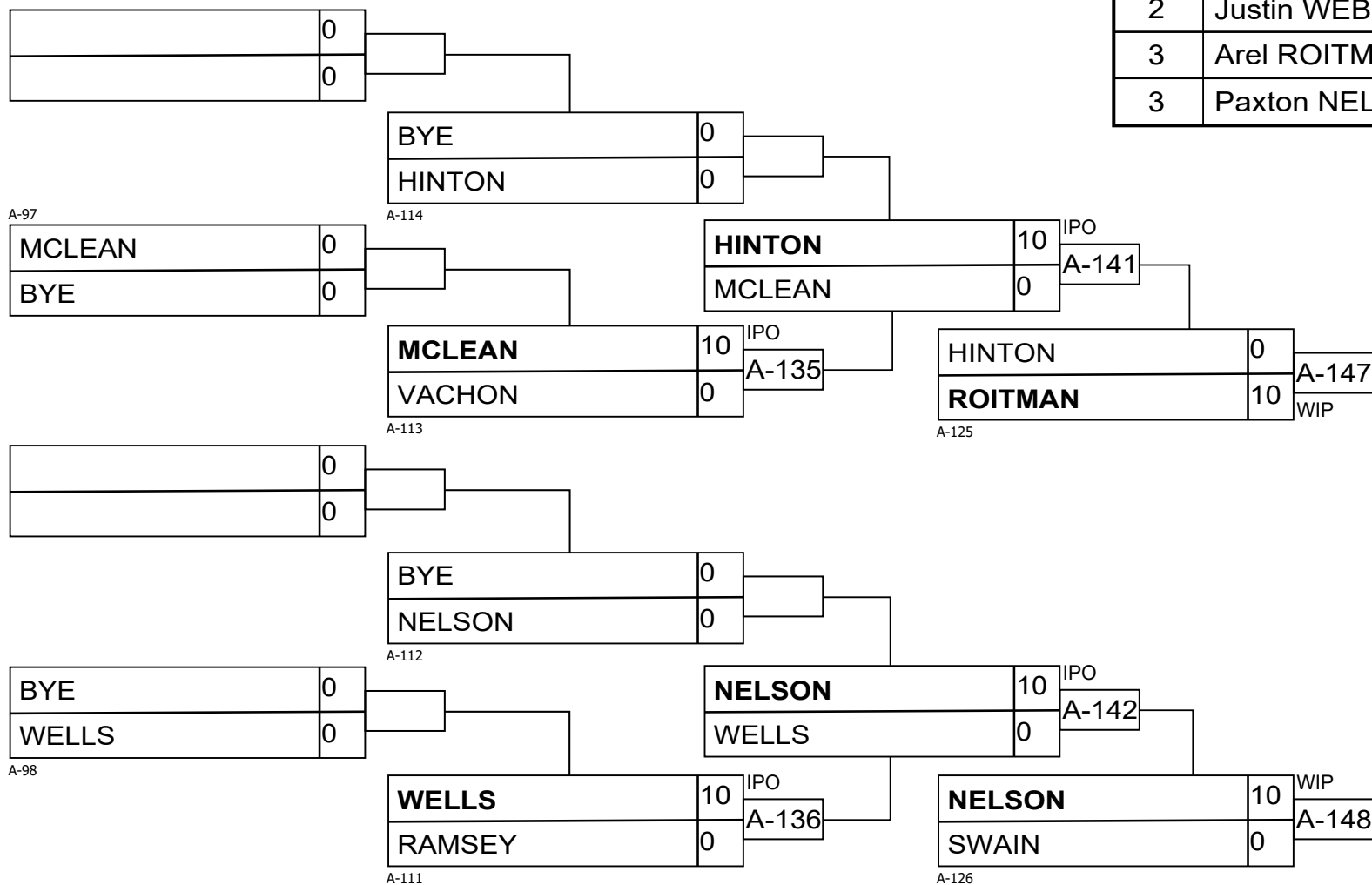

U16M -46kg

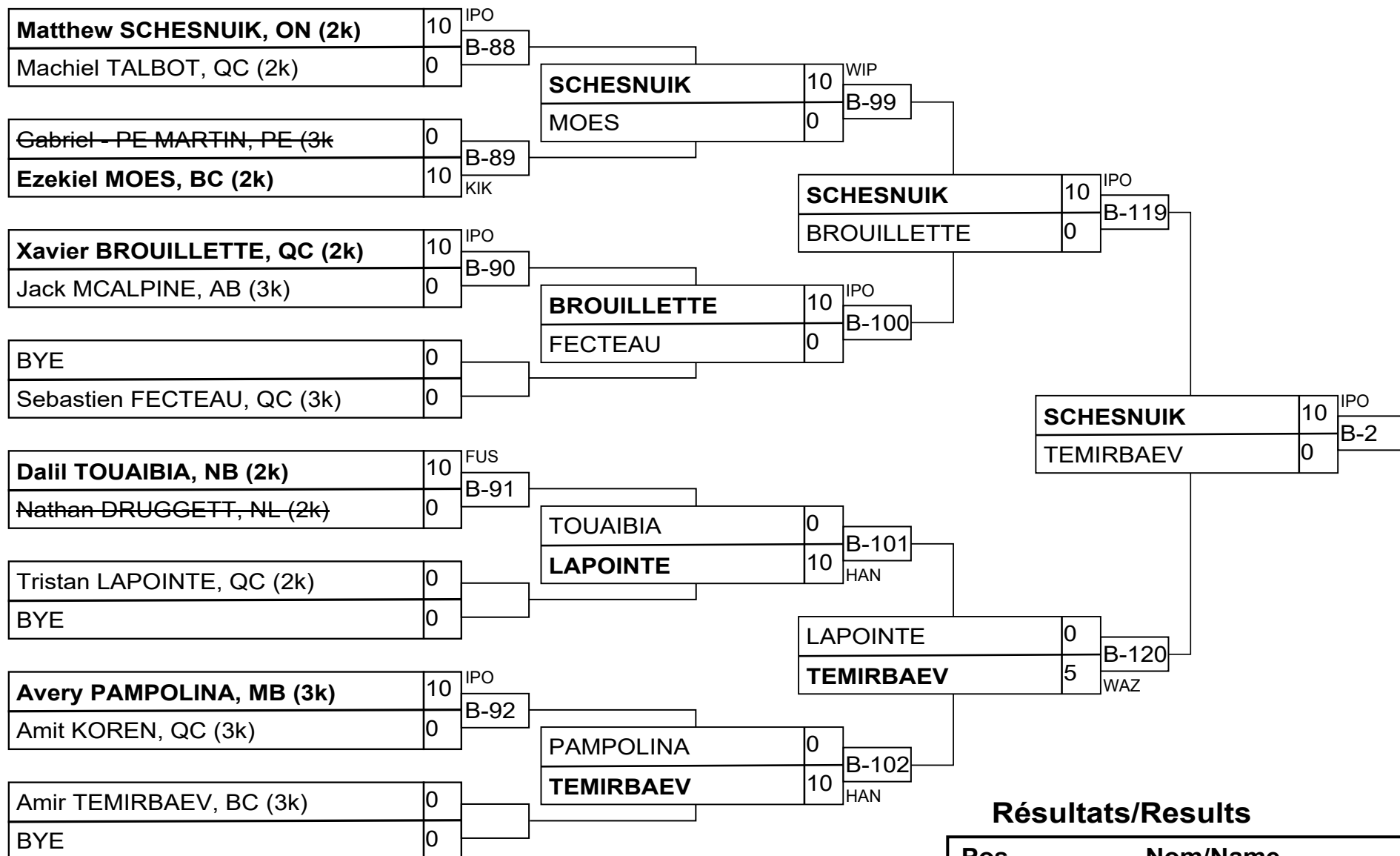

Résultats/Results

Pos	Nom/Name
1	Matthew SCHESNUIK, ON (2)
2	Amir TEMIRBAEV, BC (3k)
3	Dalil TOUAIBIA, NB (2k)
3	Tristan LAPOINTE, QC (2k)

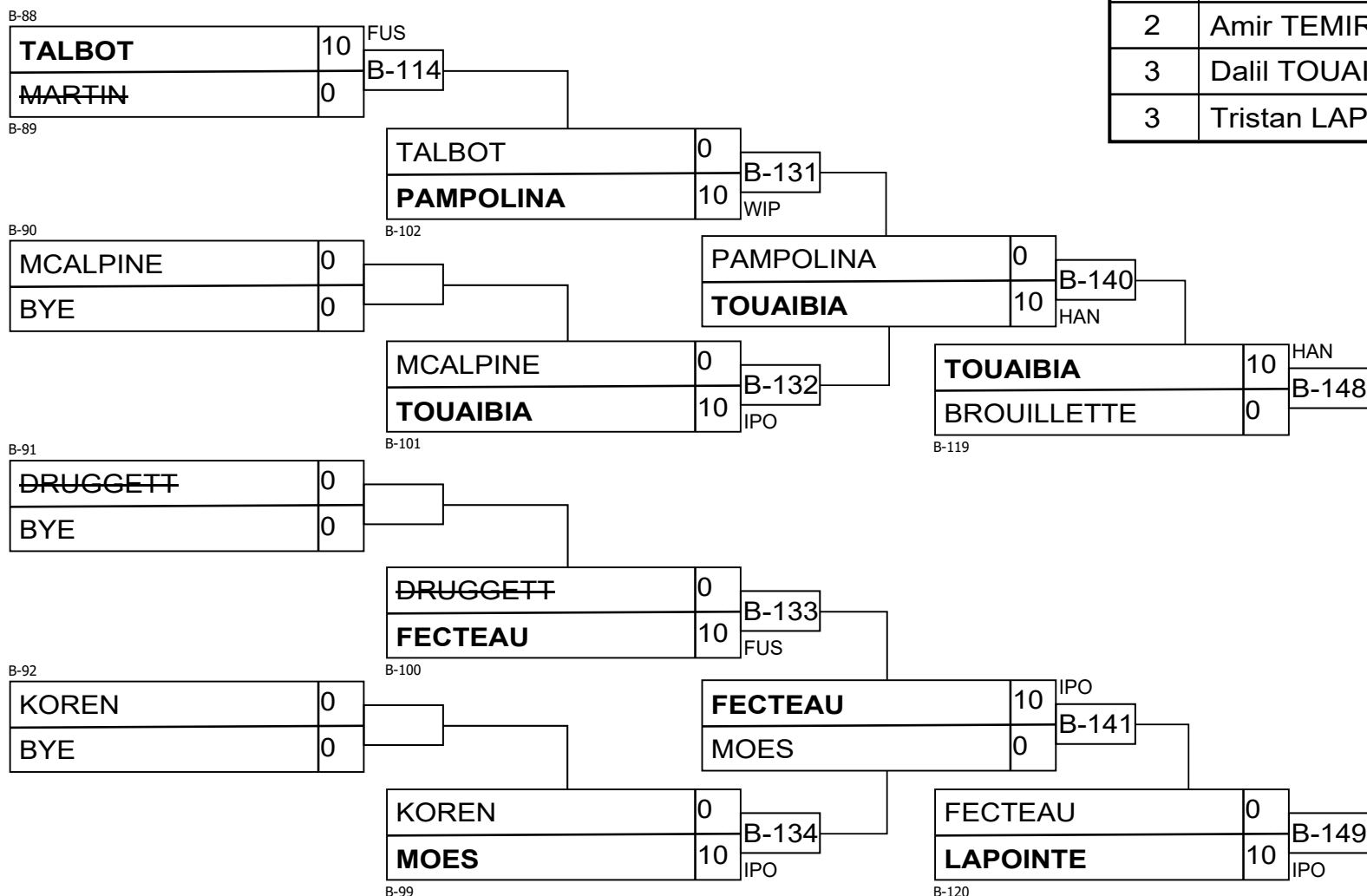

U16M -50kg

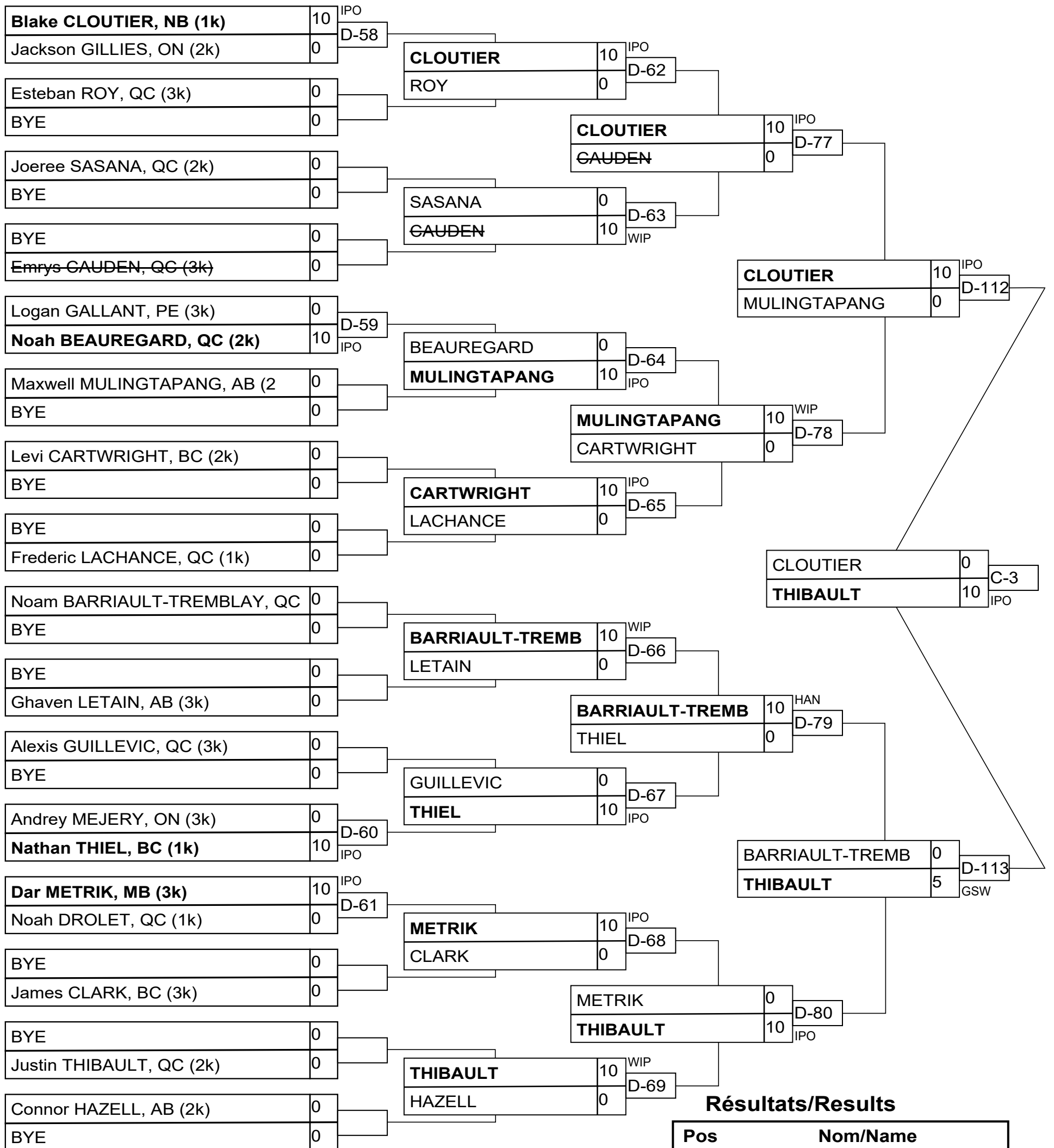

Résultats/Results

Pos	Nom/Name
1	Justin THIBAUT, QC (2k)
2	Blake CLOUTIER, NB (1k)
3	Maxwell MULINGTAPANG, AB
3	Noam BARRIAULT-TREMBLAY

U16M -50kg

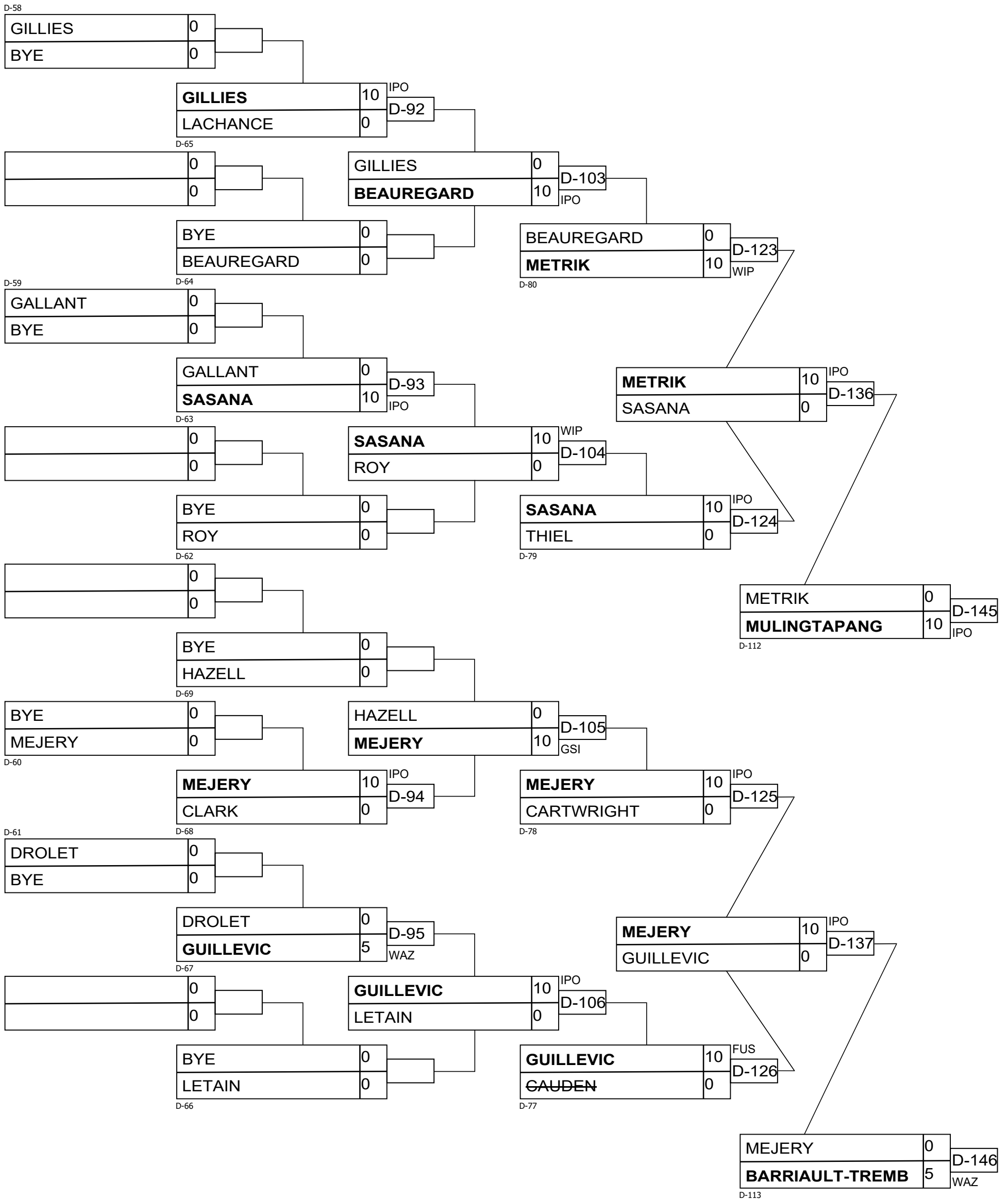

U16M -55kg

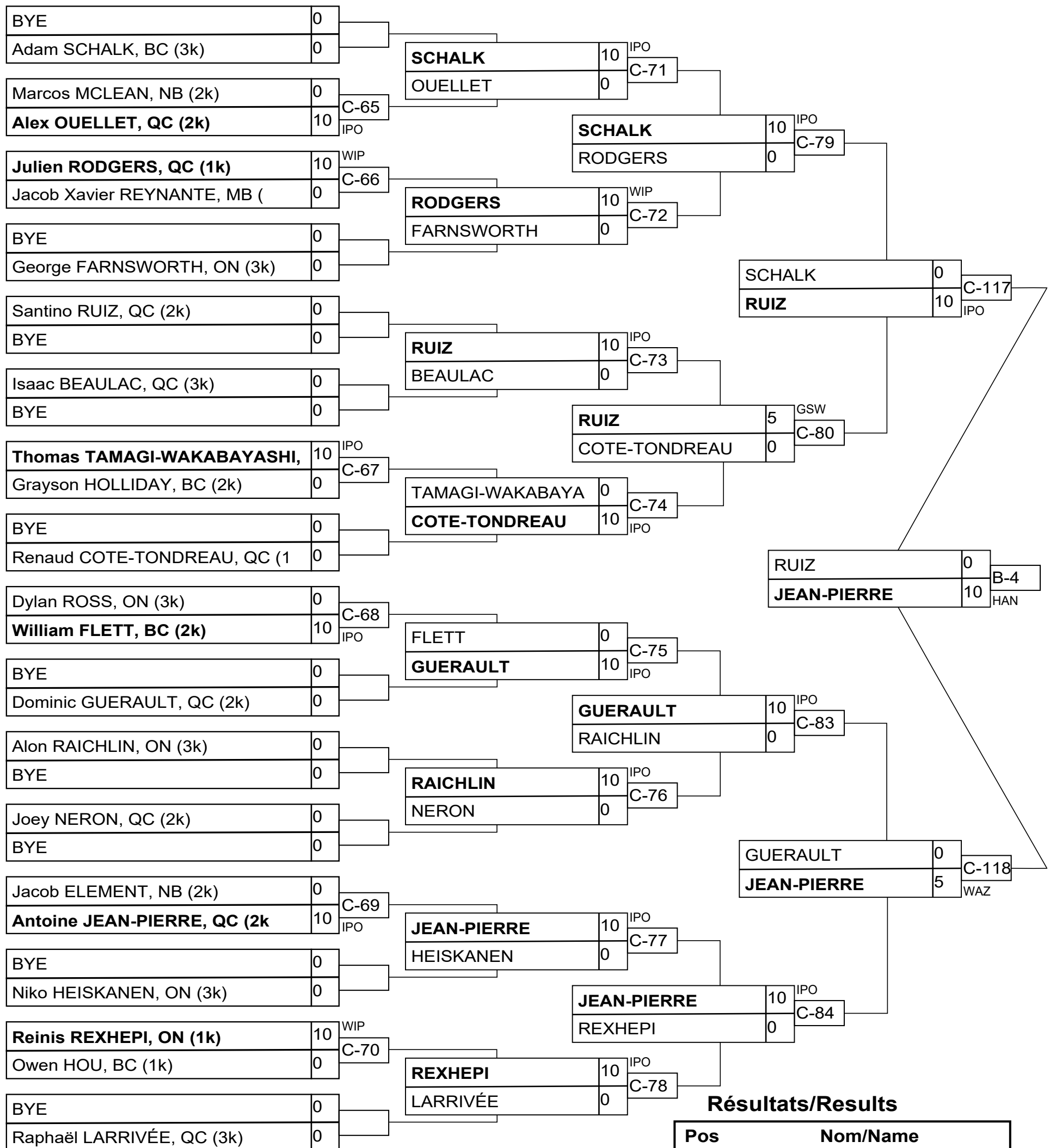

Résultats/Results

Pos	Nom/Name
1	Antoine JEAN-PIERRE, QC
2	Santino RUIZ, QC (2k)
3	Reinis REXHEPI, ON (1k)
3	Dominic GUERALT, QC (2k)

U16M -55kg

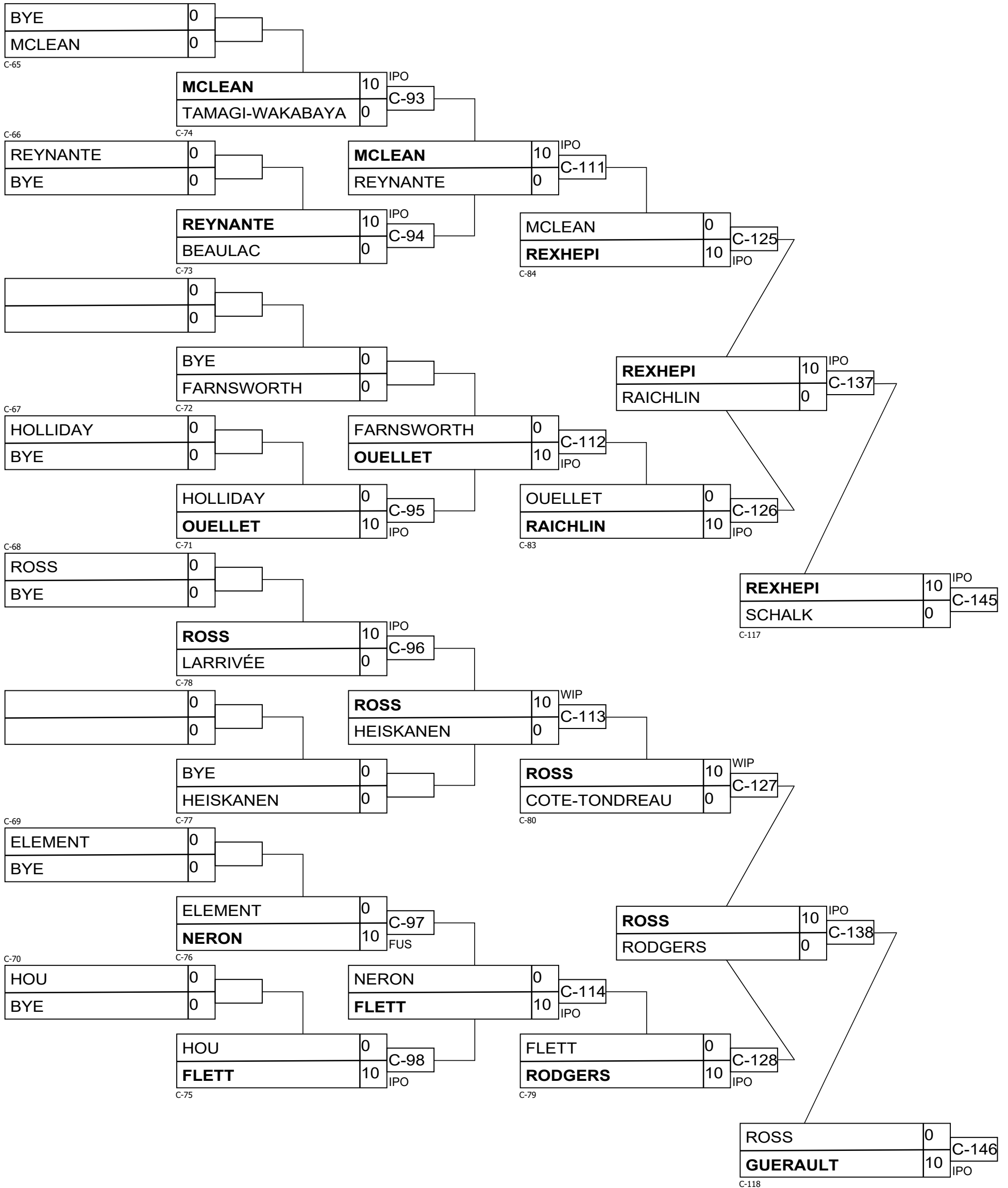

U16M -60kg

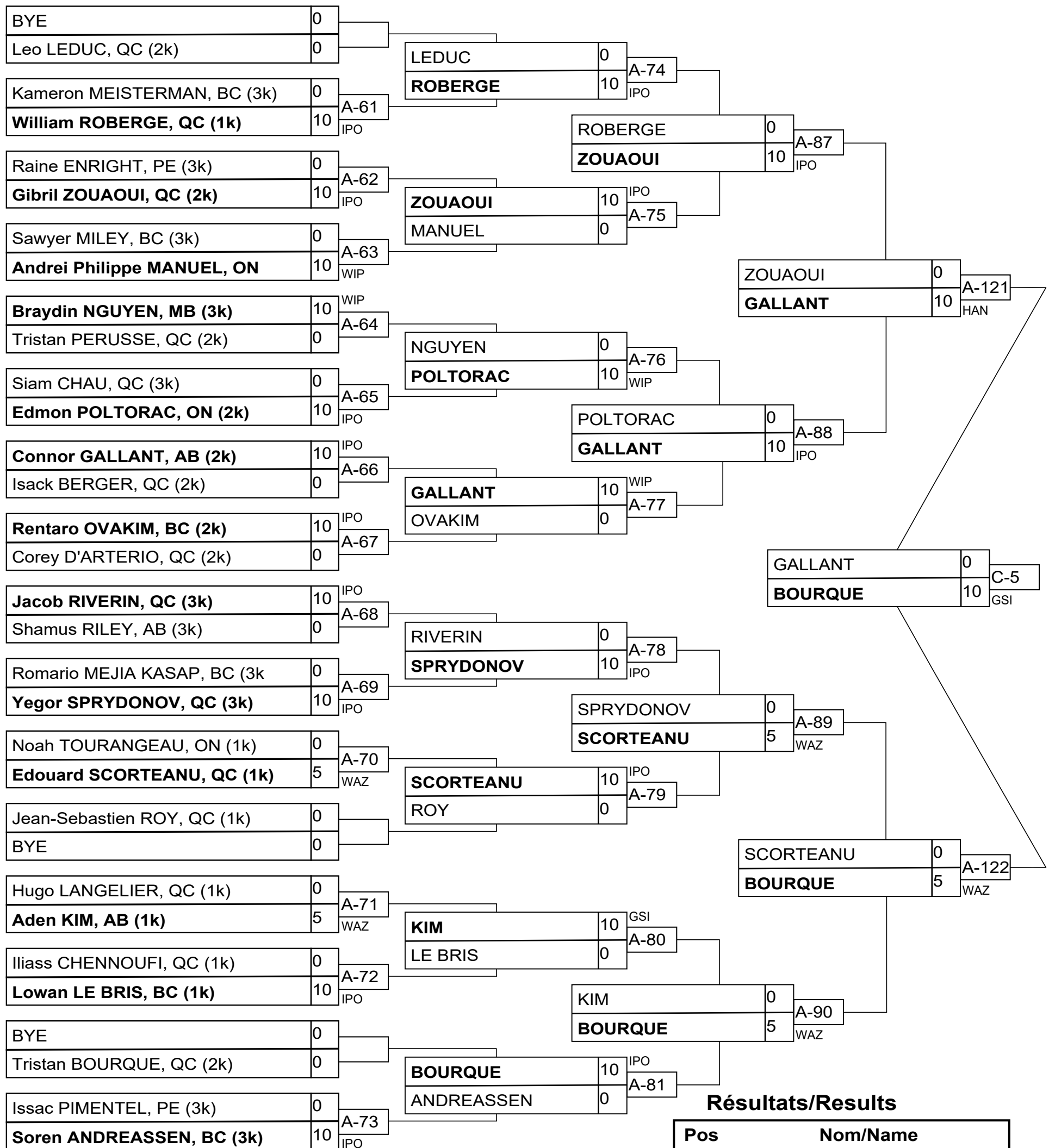

Résultats/Results

Pos	Nom/Name
1	Tristan BOURQUE, QC (2k)
2	Connor GALLANT, AB (2k)
3	Aden KIM, AB (1k)
3	Lowan LE BRIS, BC (1k)

U16M -60kg

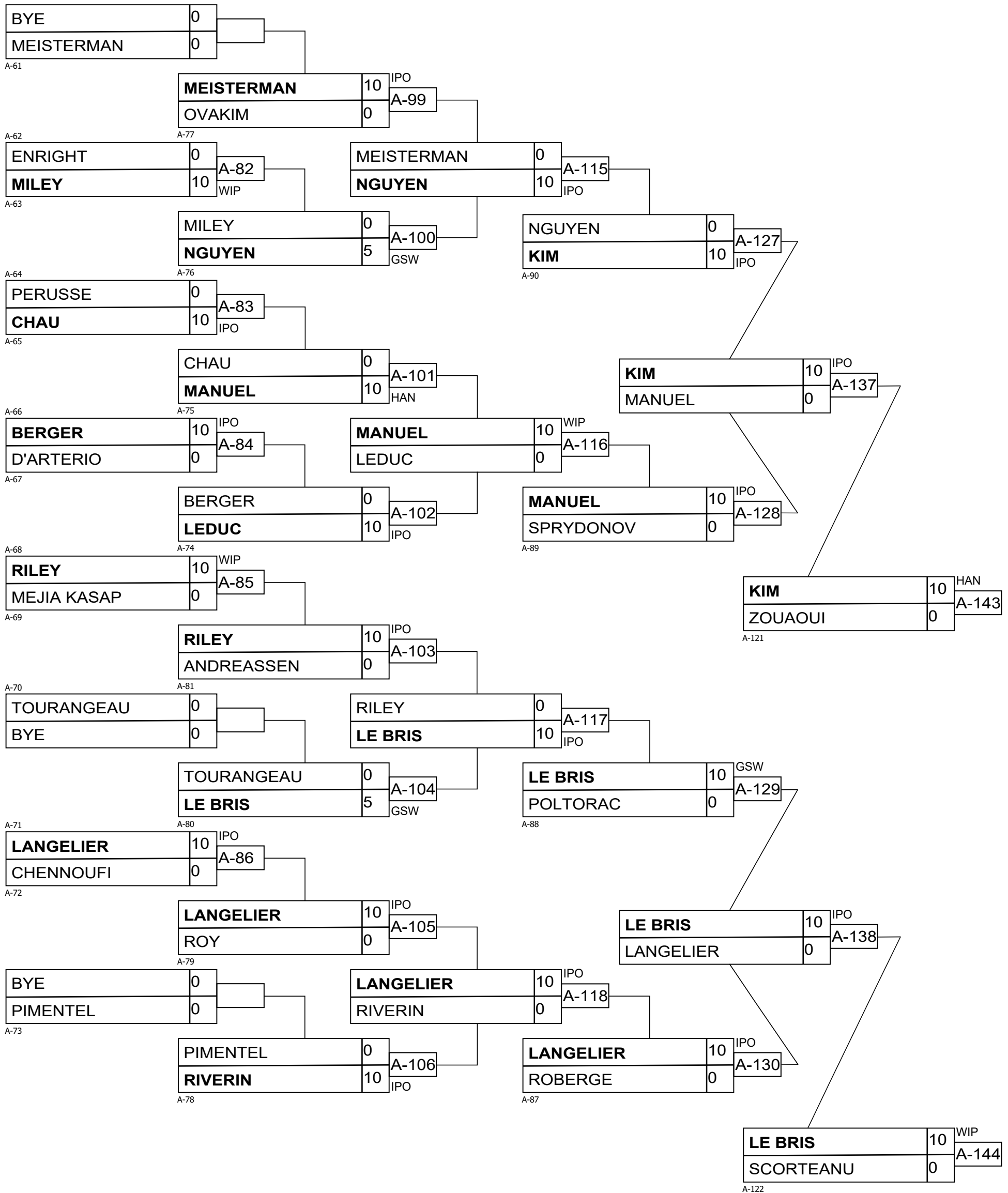

U16M -66kg

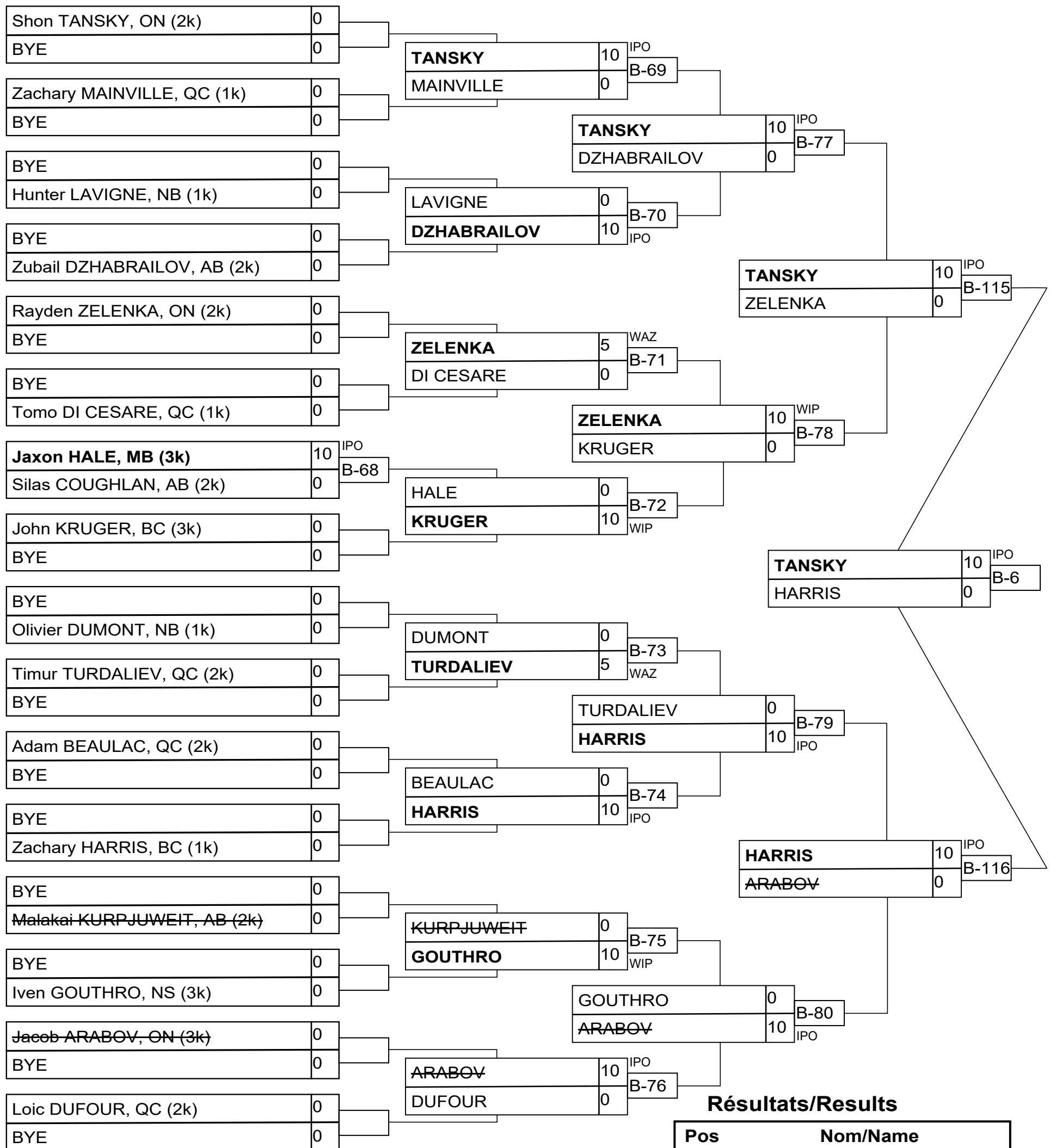

Résultats/Results

Pos	Nom/Name
1	Shon TANSKY, ON (2k)
2	Zachary HARRIS, BC (1k)
3	Tomo DI CESARE, QC (1k)
3	

U16M -66kg

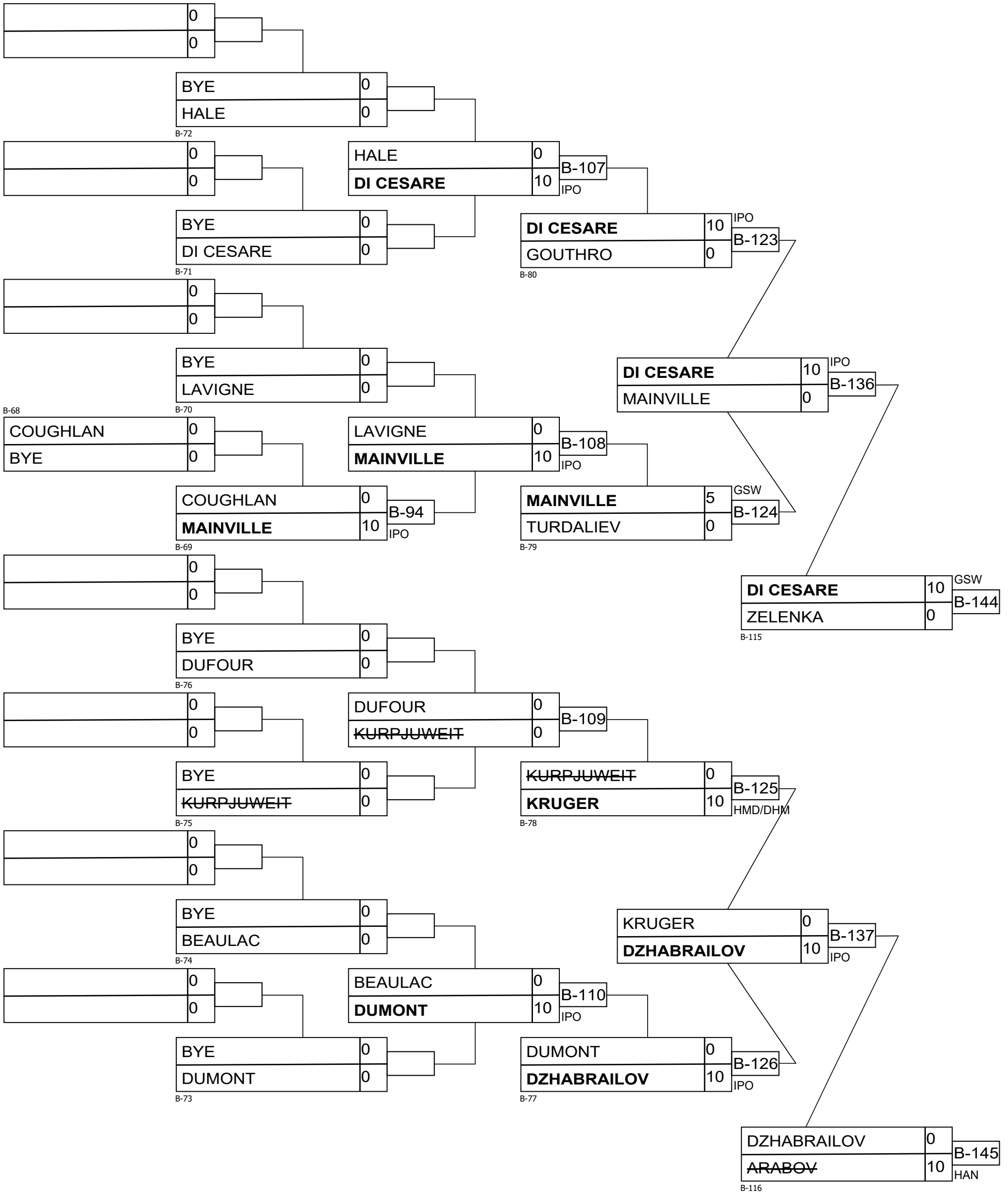

U16M -73kg

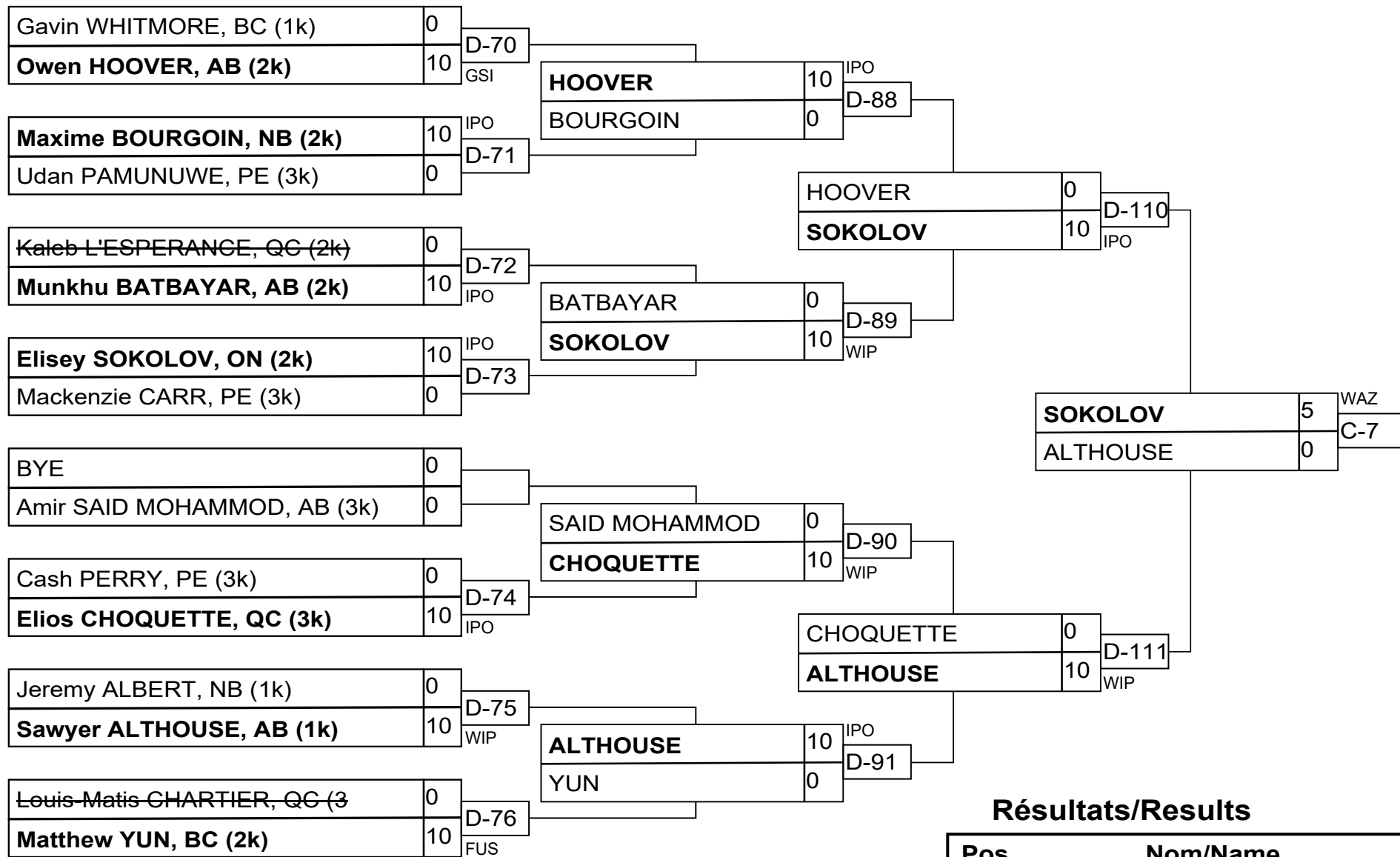

Résultats/Results

Pos	Nom/Name
1	Elisey SOKOLOV, ON (2k)
2	Sawyer ALTHOUSE, AB (1k)
3	Matthew YUN, BC (2k)
3	Munkhu BATBAYAR, AB (2k)

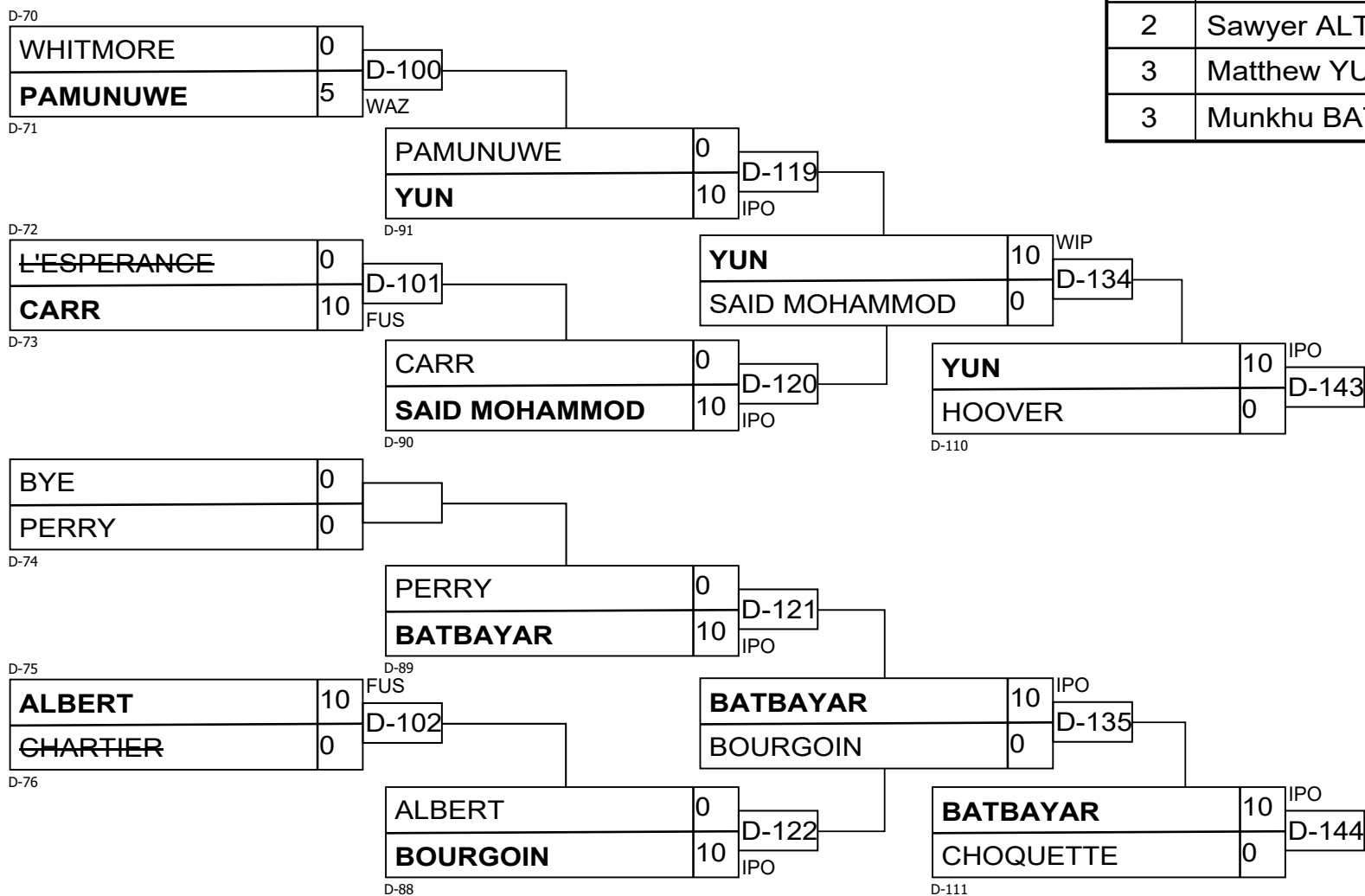

U16M +73kg

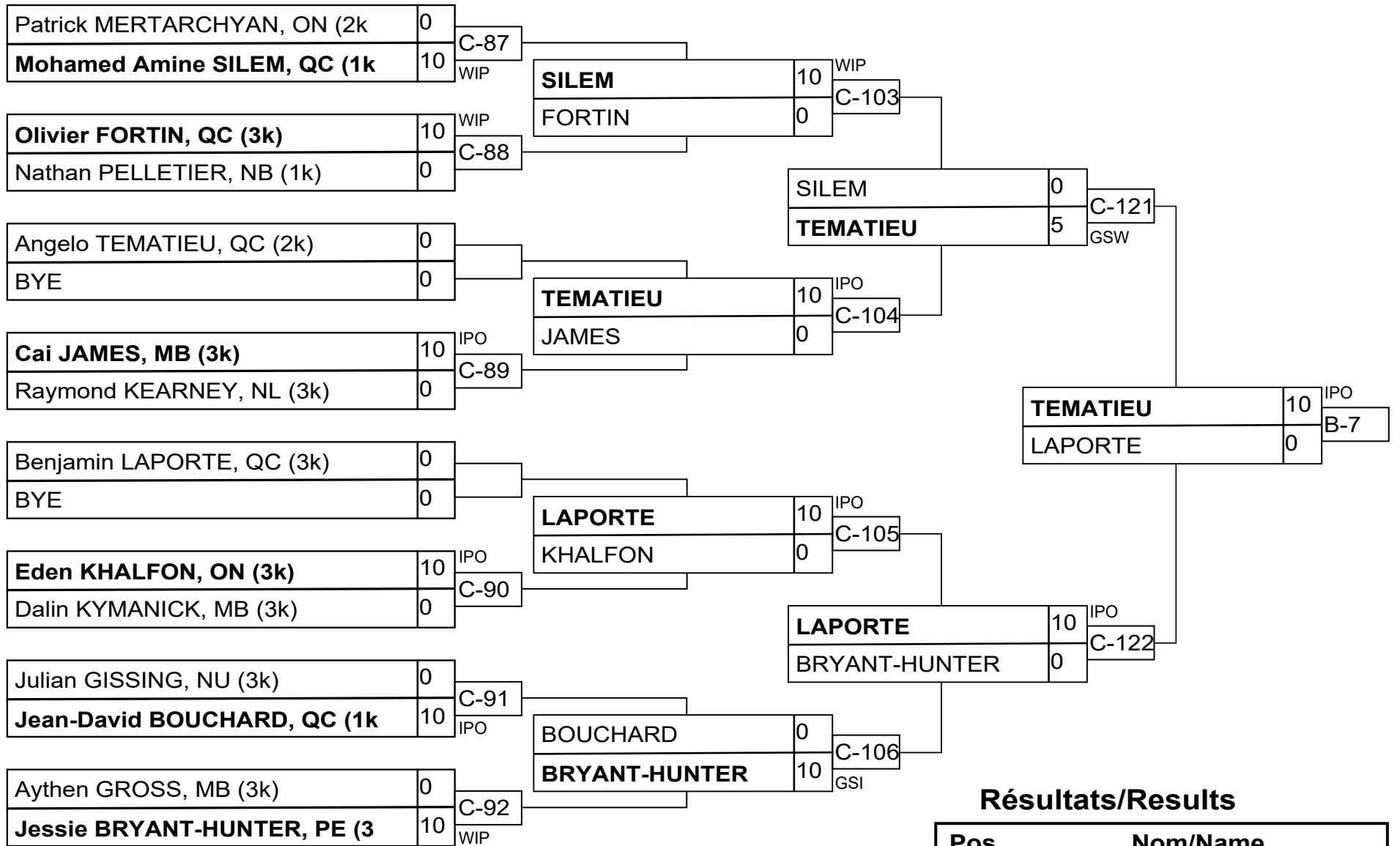

Résultats/Results

Pos	Nom/Name
1	Angelo TEMATIEU, QC (2k)
2	Benjamin LAPORTE, QC (3k)
3	Mohamed Amine SILEM, QC
3	Julian GISSING, NU (3k)

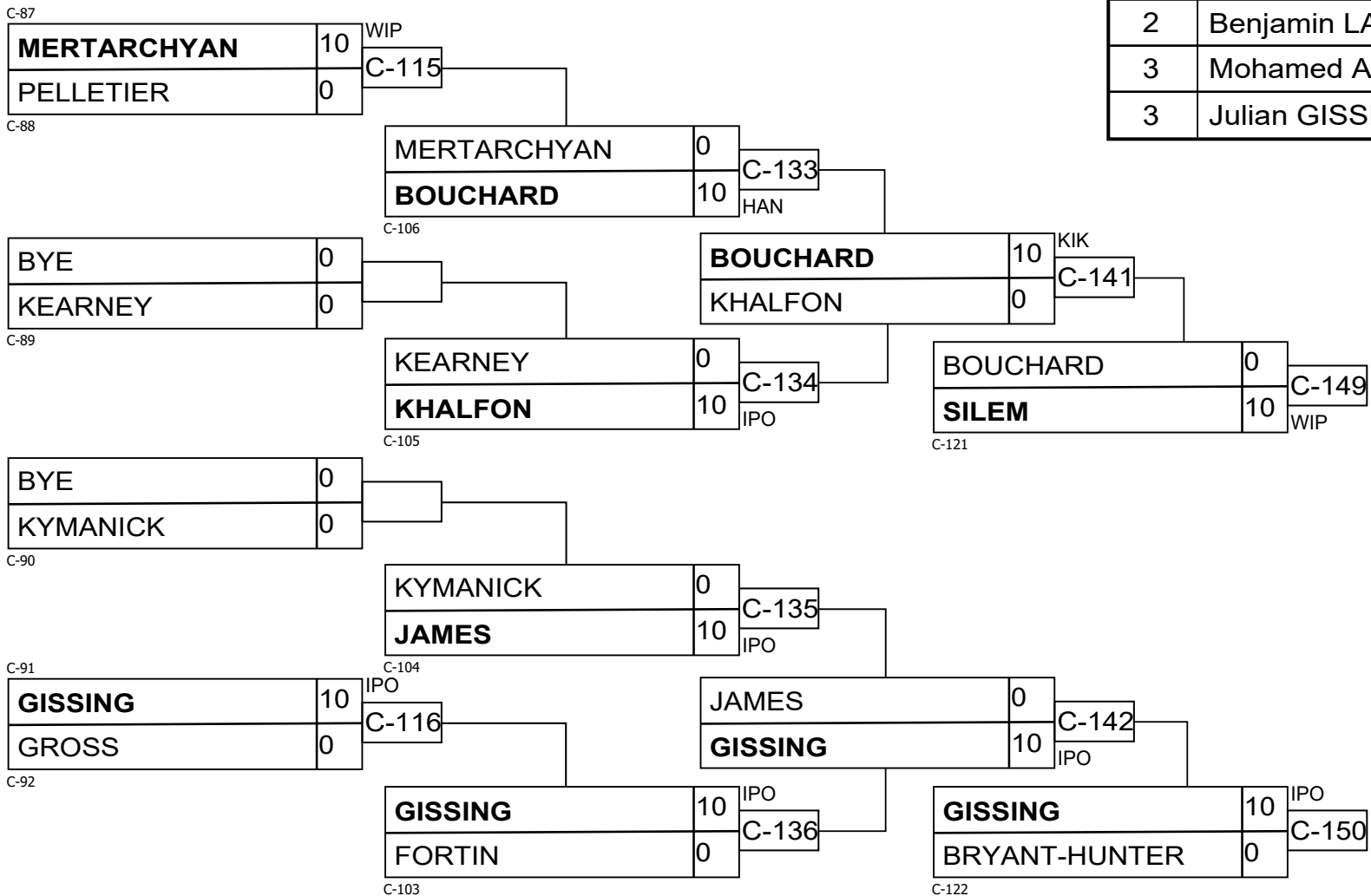

U21F -48kg

Compétiteurs/Competitors A

#	Nom/Name	Grade	Club	1	2	3	4	G/W	Pts	Pos
1	Ekaterina DANILKOV	1k	BC	XX			10	1	10	3
2	Monica ORTIZ	1k	QC	10	XX	10	10	3	30	1
3	Marie-Lune TURMEL	1k	QC	10		XX	10	2	20	2
4	Abigail SHEEHAN	2k	BC				XX	0	0	4

Pool A

Match	Blanc/White	Bleu/Blue	Rés/Res	Tmp/Tim	Code
B-42	Ekaterina DANILKOV 1 2	Monica ORTIZ	0 - 10	3:03	IPO
B-43	Marie-Lune TURMEL 3 4	Abigail SHEEHAN	10 - 0	0:47	IPO
B-52	Ekaterina DANILKOV 1 3	Marie-Lune TURMEL	0 - 10	2:03	HAN
B-53	Monica ORTIZ 2 4	Abigail SHEEHAN	10 - 0	0:28	IPO
B-59	Ekaterina DANILKOV 1 4	Abigail SHEEHAN	10 - 0	0:57	IPO
B-60	Monica ORTIZ 2 3	Marie-Lune TURMEL	10 - 0	3:20	WIP

Compétiteurs/Competitors B

#	Nom/Name	Grade	Club	5	6	7	G/W	Pts	Pos
5	Eve GALIAZZO	1k	QC	XX			0	0	3
6	Heidi QUACH	1k	QC	10	XX	10	2	20	1
7	Anne Hyunkyung LEE	1k	ON	10		XX	1	10	2

Pool B

Match	Blanc/White	Bleu/Blue	Rés/Res	Tmp/Tim	Code
B-44	Eve GALIAZZO 5 6	Heidi QUACH	0 - 10	0:05	IPO
B-54	Eve GALIAZZO 5 7	Anne Hyunkyung LEE	0 - 10	0:39	IPO
B-61	Heidi QUACH 6 7	Anne Hyunkyung LEE	10 - 0	0:06	IPO

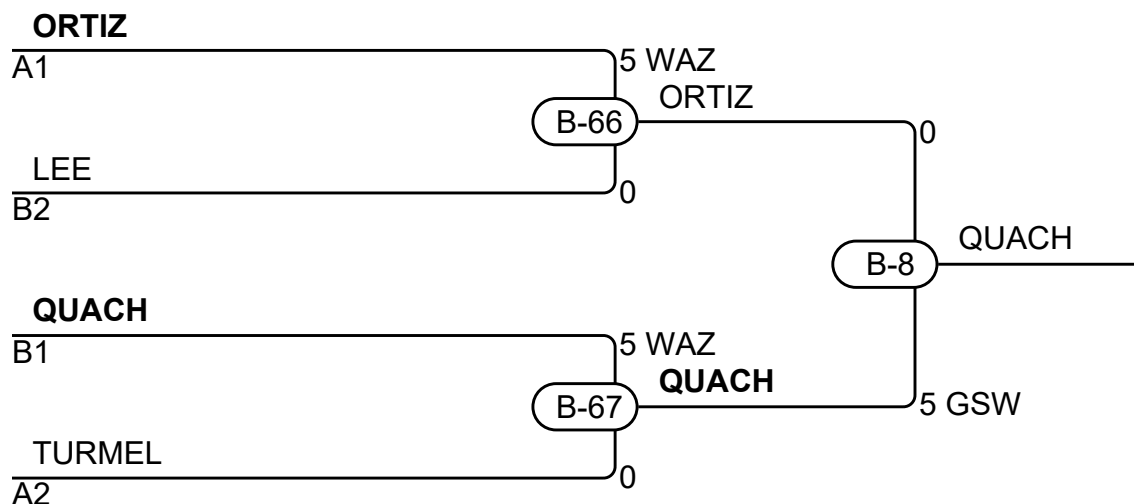

Résultats/Results

Pos	Nom/Name
1	Heidi QUACH, QC
2	Monica ORTIZ, QC
3	Anne Hyunkyung LEE, ON
3	Marie-Lune TURMEL, QC

U21F -52kg

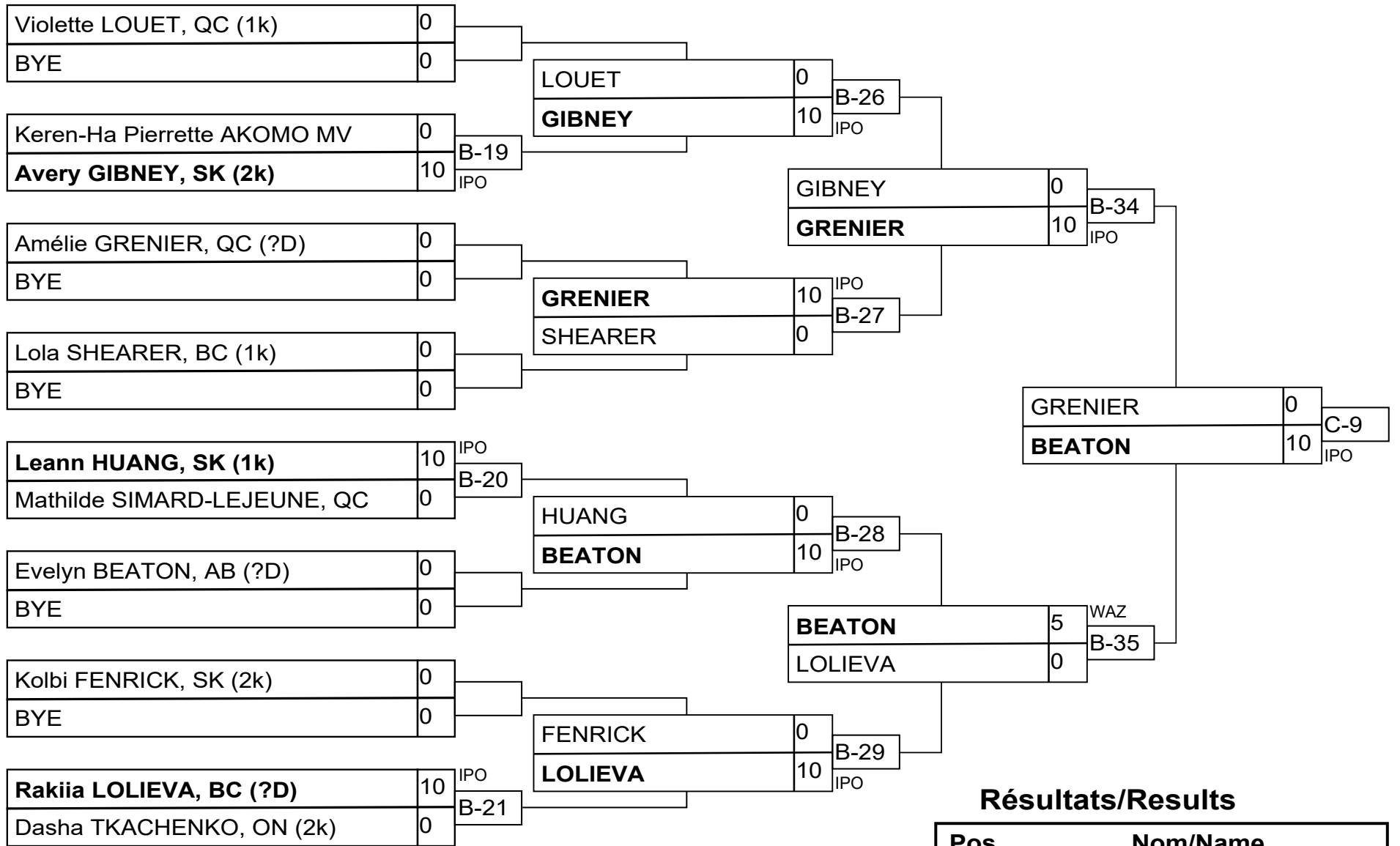

Résultats/Results

Pos	Nom/Name
1	Evelyn BEATON, AB (?D)
2	Amélie GRENIER, QC (?D)
3	Leann HUANG, SK (1k)
3	Rakiia LOLIEVA, BC (?D)

BYE	0
AKOMO MVOLO	0

B-19

AKOMO MVOLO	10	IPO
FENRICK	0	B-45

B-29

	0
	0

AKOMO MVOLO	0	
HUANG	10	IPO

BYE	0
HUANG	0

B-28

HUANG	10	WIP
GIBNEY	0	B-62

B-34

SIMARD-LEJEUNE	0
BYE	0

SIMARD-LEJEUNE	10	WIP
SHEARER	0	B-46

B-27

BYE	0
TKACHENKO	0

SIMARD-LEJEUNE	0	
LOUET	10	WIP

TKACHENKO	0	
LOUET	5	WAZ

B-26

LOUET	0	
LOLIEVA	10	IPO

B-35

U21F -57kg

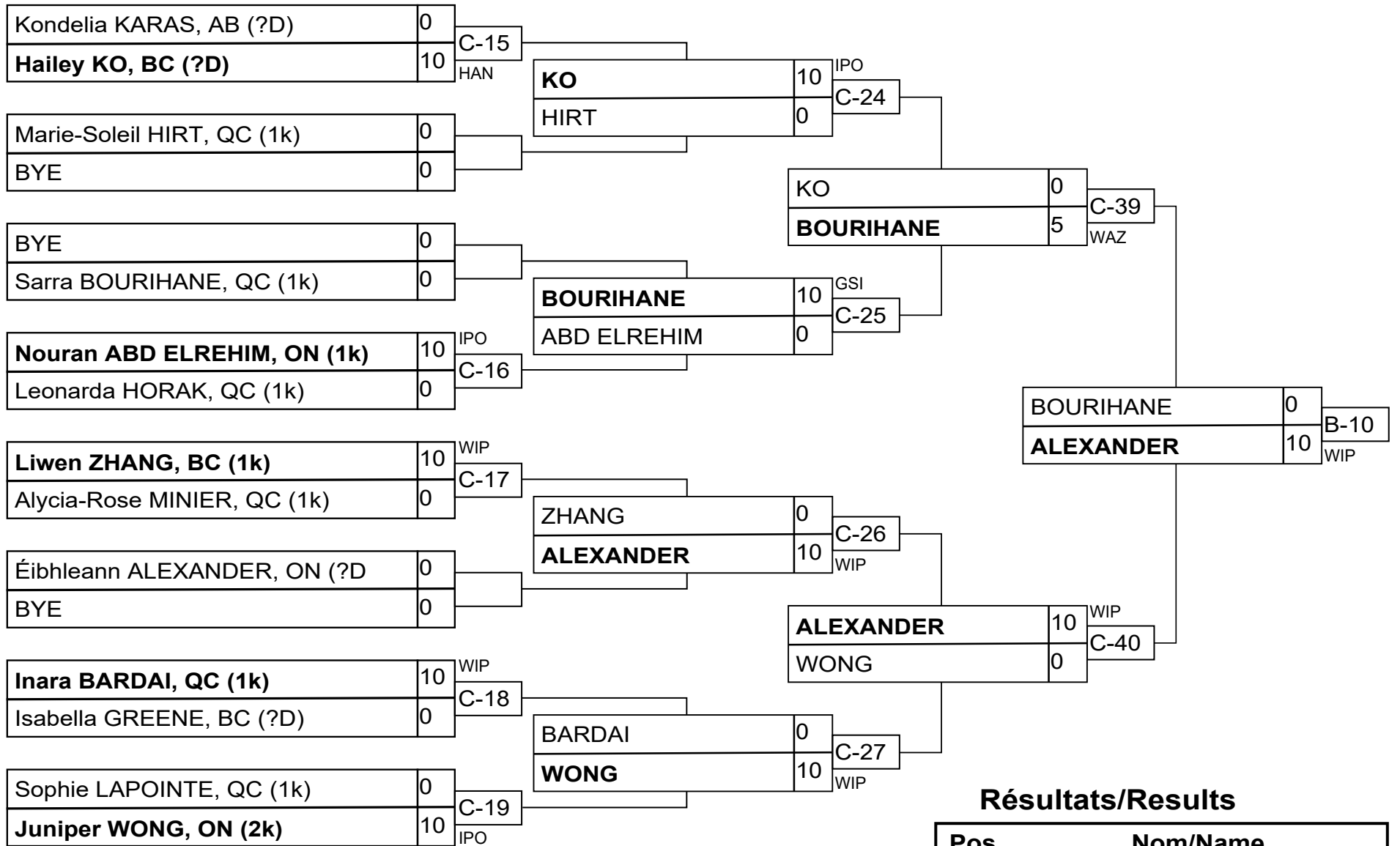

Résultats/Results

Pos	Nom/Name
1	Éibhleann ALEXANDER, ON
2	Sarra BOURIHANE, QC (1k)
3	Hailey KO, BC (?D)
3	Juniper WONG, ON (2k)

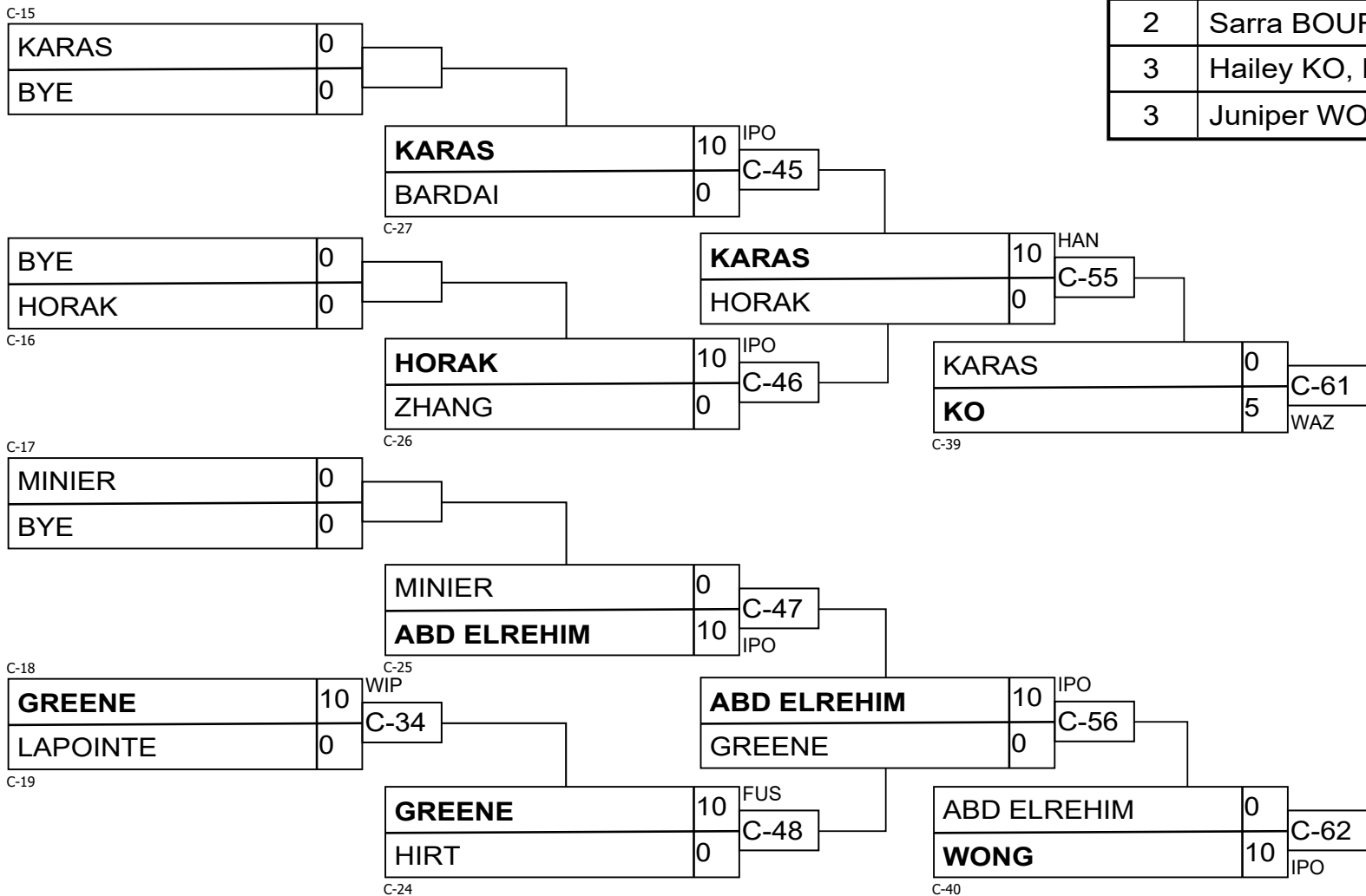

U21F -63kg

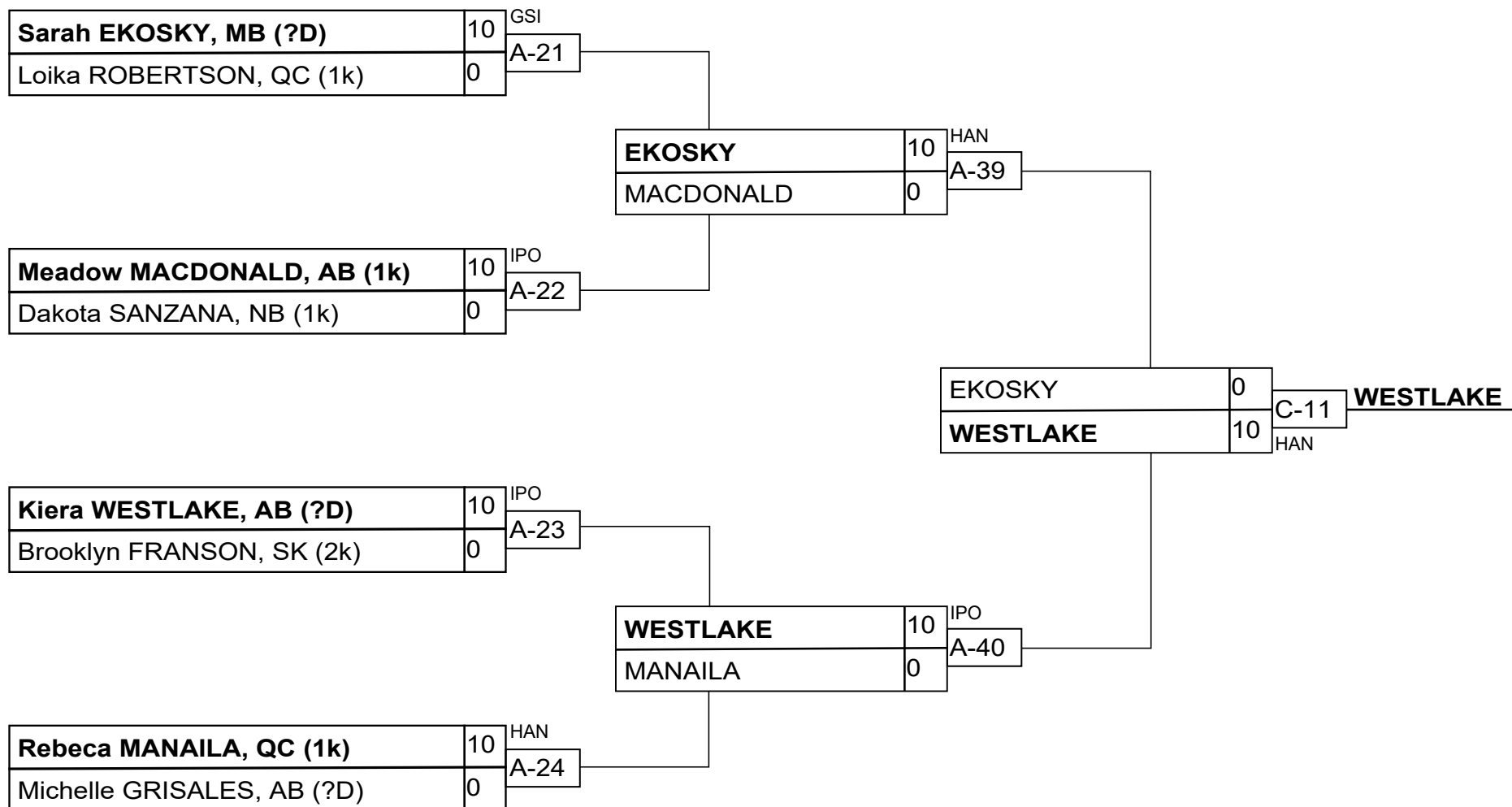

Résultats/Results

Pos	Nom/Name
1	Kiera WESTLAKE, AB (?D)
2	Sarah EKOSKY, MB (?D)
3	Meadow MACDONALD, AB (1k)
3	Rebeca MANAILA, QC (1k)

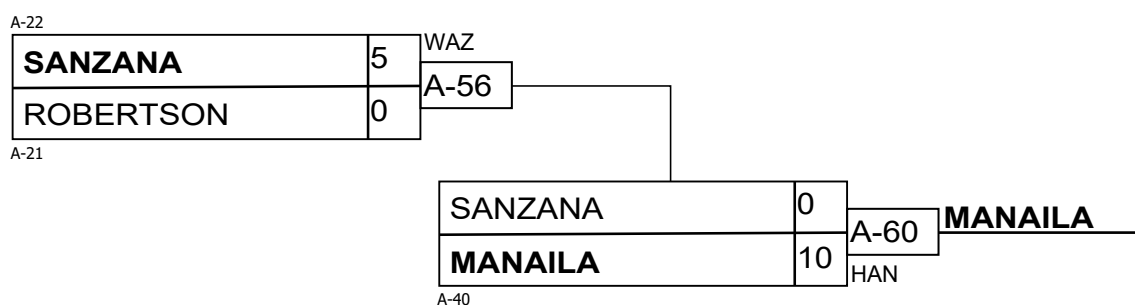
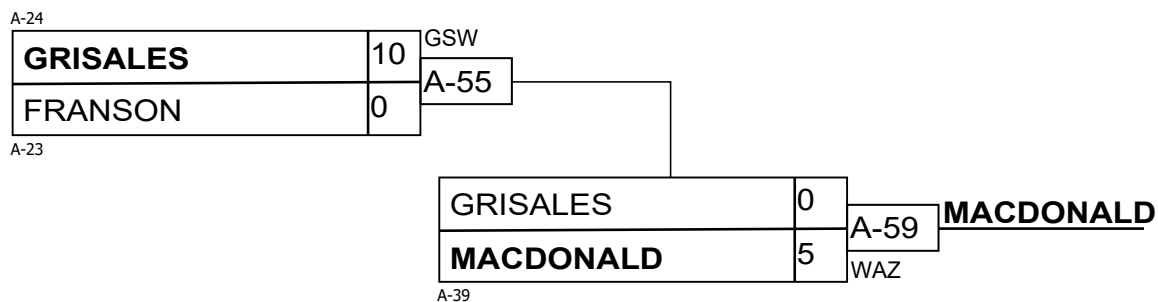

U21F -70kg

Compétiteurs/Competitors A

#	Nom/Name	Grade	Club	1	2	3	4	G/W	Pts	Pos
1	Sara GÉLINAS	1k	QC	XX				0	0	4
2	Justine SIMARD	?D	QC	10	XX			1	10	3
3	Alexandria LEFORT	?D	ON	10	10	XX		2	20	2
4	Brae BOOTH	?D	BC	10	10	5	XX	3	25	1

Pool A

Match	Blanc/White			Bleu/Blue	Rés/Res	Tmp/Tim	Code
D-33	Sara GÉLINAS	1	2	Justine SIMARD	0 - 10	0:18	IPO
D-34	Alexandria LEFORT	3	4	Brae BOOTH	0 - 5	6:06	GSW
D-42	Sara GÉLINAS	1	3	Alexandria LEFORT	0 - 10	0:08	IPO
D-43	Justine SIMARD	2	4	Brae BOOTH	0 - 10	0:00	FUS
D-49	Sara GÉLINAS	1	4	Brae BOOTH	0 - 10	0:48	WIP
D-50	Justine SIMARD	2	3	Alexandria LEFORT	0 - 10	0:00	FUS

Compétiteurs/Competitors B

#	Nom/Name	Grade	Club	5	6	7	G/W	Pts	Pos
5	Rebecca VILLA	1k	MB	XX			0	0	3
6	Laurence BIRON	1k	QC	10	XX	10	2	20	1
7	Loane GILL	1k	QC	10		XX	1	10	2

Pool B

Match	Blanc/White			Bleu/Blue	Rés/Res	Tmp/Tim	Code
D-35	Rebecca VILLA	5	6	Laurence BIRON	0 - 10	0:53	WIP
D-44	Rebecca VILLA	5	7	Loane GILL	0 - 10	5:53	HAN
D-51	Laurence BIRON	6	7	Loane GILL	10 - 0	3:53	IPO

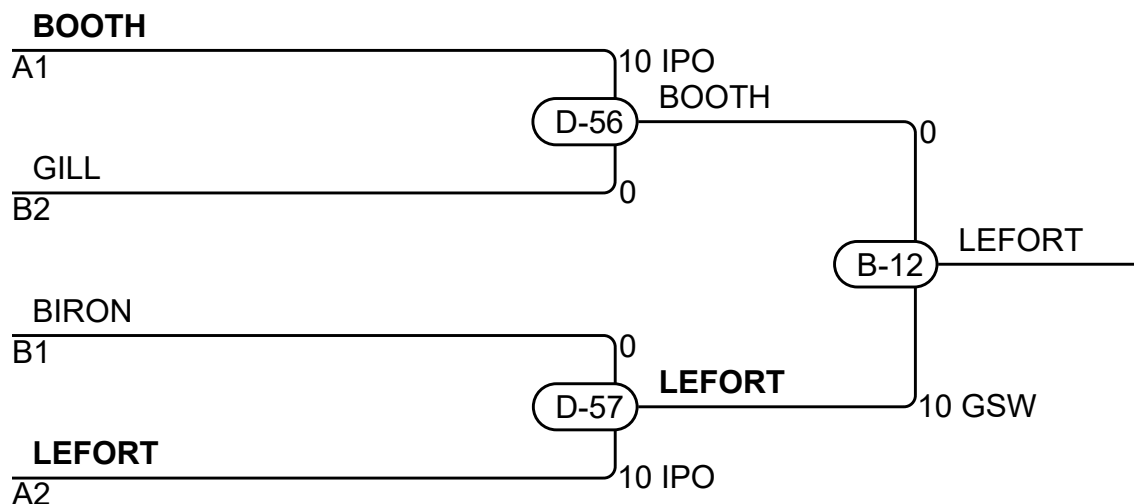

Résultats/Results

Pos	Nom/Name
1	Alexandria LEFORT, ON
2	Brae BOOTH, BC
3	Loane GILL, QC
3	Laurence BIRON, QC

U21F -78kg

Compétiteurs/Competitors

#	Nom/Name	Grade	Club	1	2	1	2	1	2	G/W	Pts	Pos
1	Loren ENMAN	?D	PE	XX		XX		XX		0	0	2
2	Frederique LAVIGNE	1k	QC	10	XX	10	XX		XX	2	20	1

Matches/Matches

Match	Blanc/White			Bleu/Blue	Rés/Res	Tmp/Tim	Code
C-44	Loren ENMAN	1	2	Frederique LAVIGNE	0 - 10	0:45	WIP
C-54	Frederique LAVIGNE	2	1	Loren ENMAN	10 - 0	1:04	WIP
C-60	Loren ENMAN	1	2	Frederique LAVIGNE			

Résultats/Results

Pos	Nom/Name
1	Frederique LAVIGNE, QC

U21F +78kg

Compétiteurs/Competitors

#	Nom/Name	Grade	Club	1	2	3	4	5	G/W	Pts	Pos
1	Marianna KARAS	2k	AB	XX		10	10		2	20	3
2	Brandi LINGLEY	1k	NB	5	XX	10	10	10	4	35	1
3	Emilie TOWNSEND	1k	NS			XX	10		1	10	4
4	Charlie BISSON	1k	QC				XX		0	0	5
5	Sara DESBIENS	?D	QC	10		10	10	XX	3	30	2

Matches/Matches

Match	Blanc/White			Bleu/Blue	Rés/Res	Tmp/Tim	Code
A-19	Charlie BISSON	4	5	Sara DESBIENS	0 - 10	0:25	WIP
A-20	Marianna KARAS	1	2	Brandi LINGLEY	0 - 5	4:00	WAZ
A-31	Emilie TOWNSEND	3	4	Charlie BISSON	10 - 0	0:00	WIP
A-32	Marianna KARAS	1	5	Sara DESBIENS	0 - 10	1:18	IPO
A-37	Brandi LINGLEY	2	3	Emilie TOWNSEND	10 - 0	2:06	IPO
A-38	Marianna KARAS	1	4	Charlie BISSON	10 - 0	1:23	IPO
A-47	Emilie TOWNSEND	3	5	Sara DESBIENS	0 - 10	0:00	IPO
A-48	Brandi LINGLEY	2	4	Charlie BISSON	10 - 0	0:30	IPO
A-53	Marianna KARAS	1	3	Emilie TOWNSEND	10 - 0	1:28	IPO
C-13	Brandi LINGLEY	2	5	Sara DESBIENS	10 - 0	2:33	IPO

Résultats/Results

Pos	Nom/Name
1	Brandi LINGLEY, NB
2	Sara DESBIENS, QC
3	Marianna KARAS, AB
4	Emilie TOWNSEND, NS

U21M -100kg

Compétiteurs/Competitors

#	Nom/Name	Grade	Club	1	2	3	4	5	G/W	Pts	Pos
1	Corban TAYLOR	2k	SK	XX		10	10		2	20	3
2	Michael AKBASHEV	?D	MB	10	XX	10	10		3	30	2
3	Elias LOUAHLA	1k	QC			XX	10		1	10	4
4	Ryu TAMAYOSE	1k	BC				XX		0	0	5
5	Nikola PETROVIC	?D	BC	10	5	10	10	XX	4	35	1

Matches/Matches

Match	Blanc/White			Bleu/Blue	Rés/Res	Tmp/Tim	Code
A-17	Ryu TAMAYOSE	4	5	Nikola PETROVIC	0 - 10	0:07	IPO
A-18	Corban TAYLOR	1	2	Michael AKBASHEV	0 - 10	1:59	WIP
A-29	Elias LOUAHLA	3	4	Ryu TAMAYOSE	10 - 0	0:42	WIP
A-30	Corban TAYLOR	1	5	Nikola PETROVIC	0 - 10	2:02	WIP
A-35	Michael AKBASHEV	2	3	Elias LOUAHLA	10 - 0	1:17	IPO
A-36	Corban TAYLOR	1	4	Ryu TAMAYOSE	10 - 0	0:07	IPO
A-45	Elias LOUAHLA	3	5	Nikola PETROVIC	0 - 10	1:33	IPO
A-46	Michael AKBASHEV	2	4	Ryu TAMAYOSE	10 - 0	0:20	IPO
A-51	Corban TAYLOR	1	3	Elias LOUAHLA	10 - 0	2:03	IPO
B-13	Michael AKBASHEV	2	5	Nikola PETROVIC	0 - 5	4:14	GSW

Résultats/Results

Pos	Nom/Name
1	Nikola PETROVIC, BC
2	Michael AKBASHEV, MB
3	Corban TAYLOR, SK
4	Elias LOUAHLA, QC

U21M -60kg

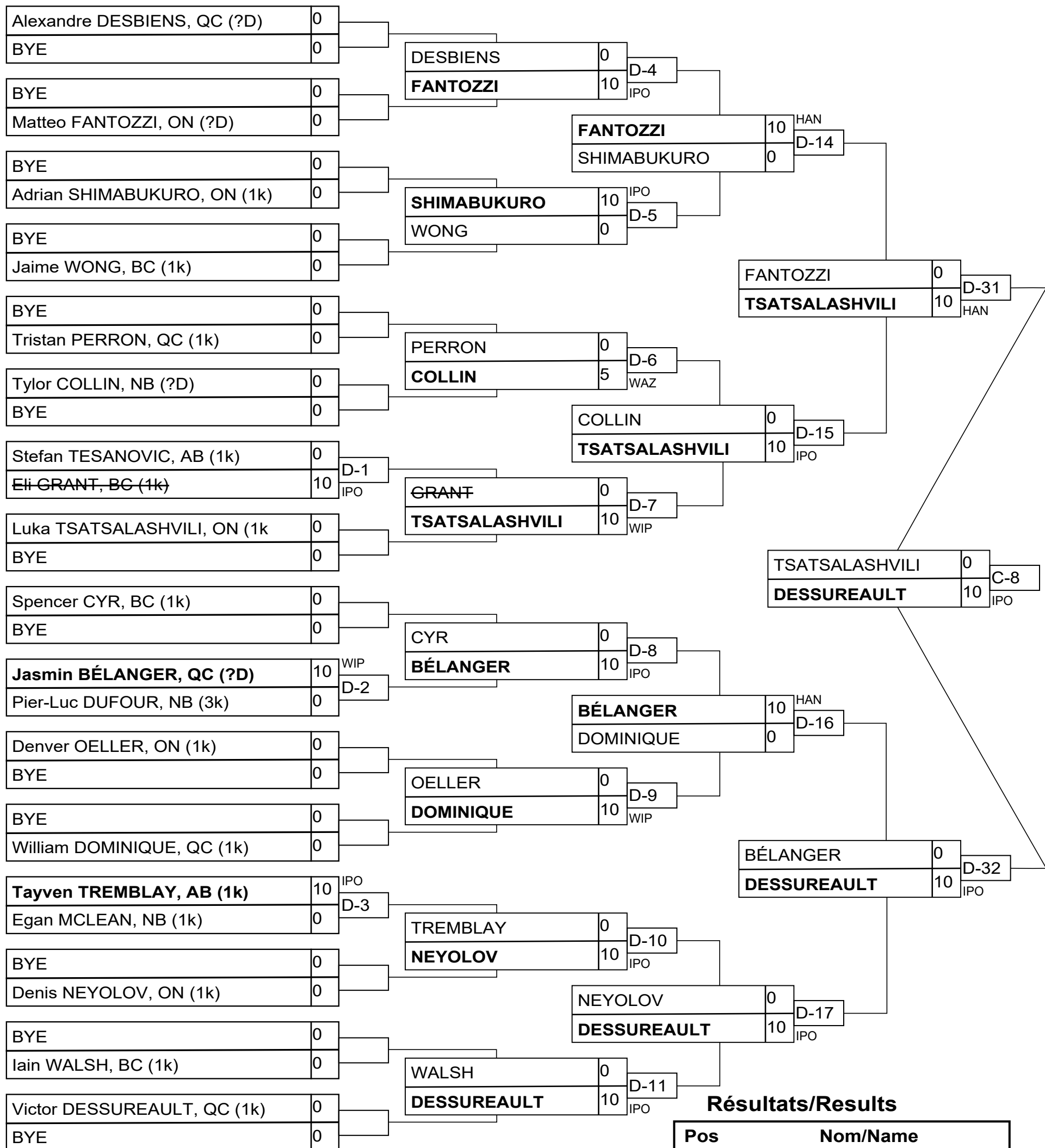

U21M -60kg

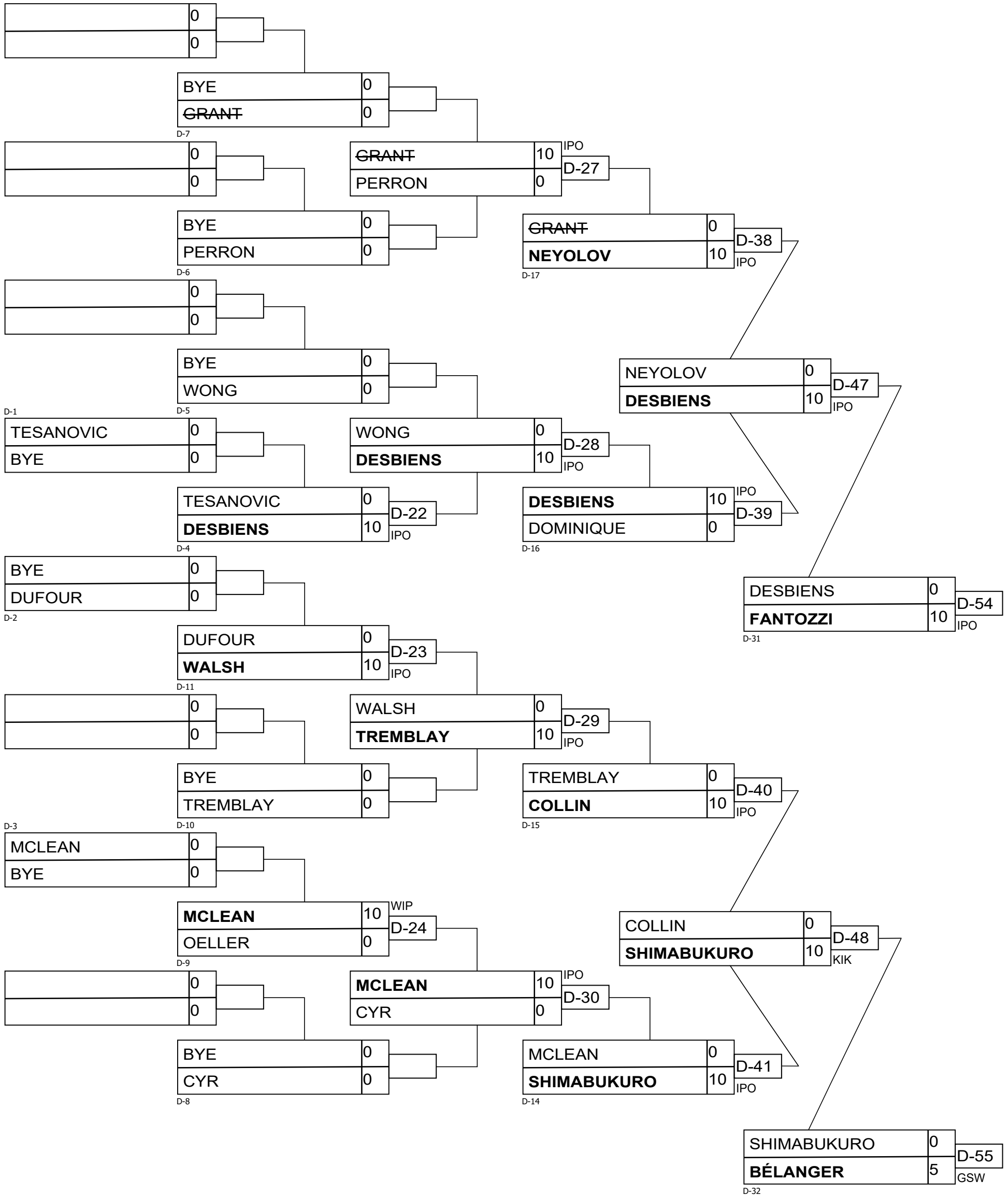

U21M -66kg

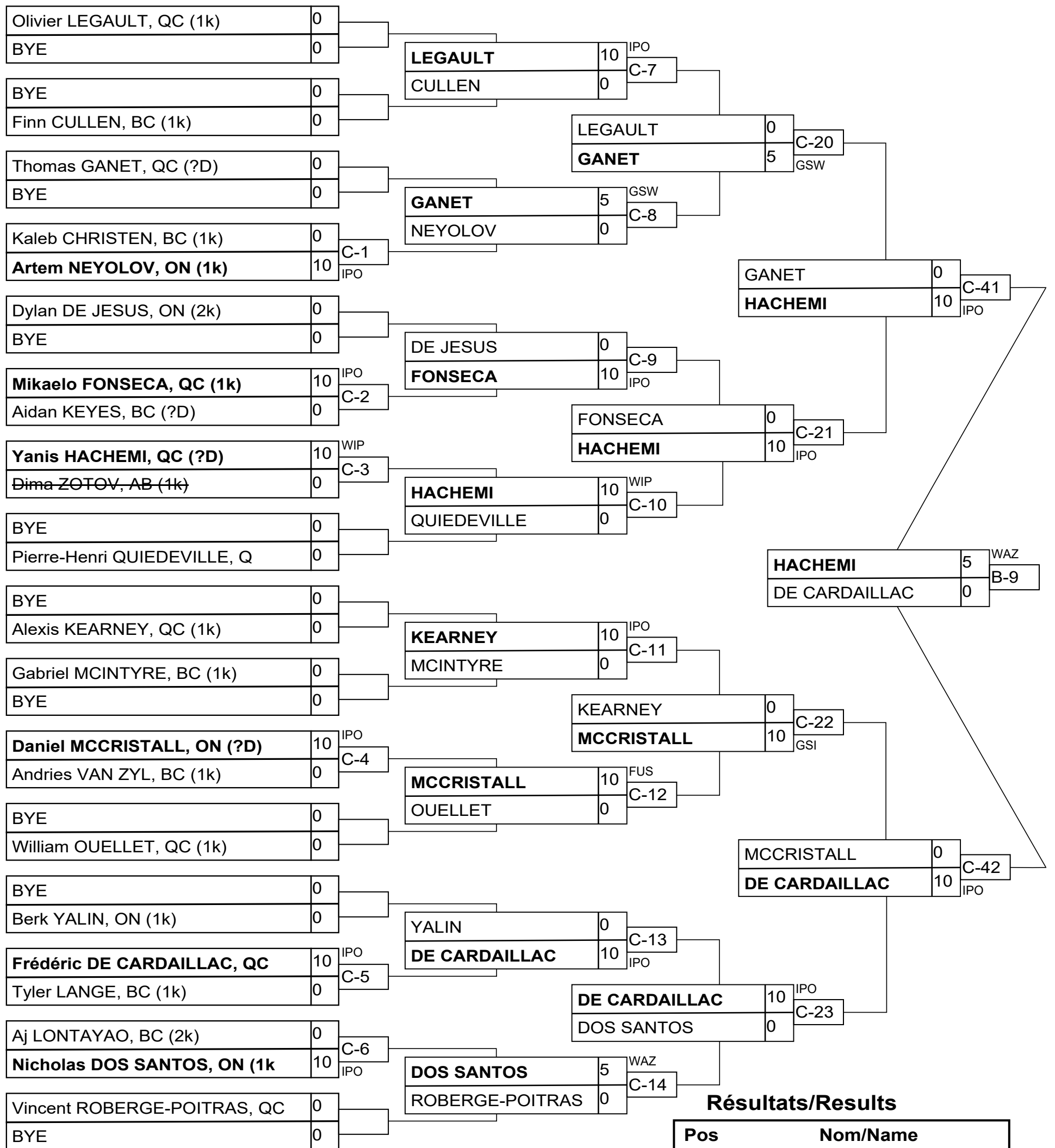

U21M -66kg

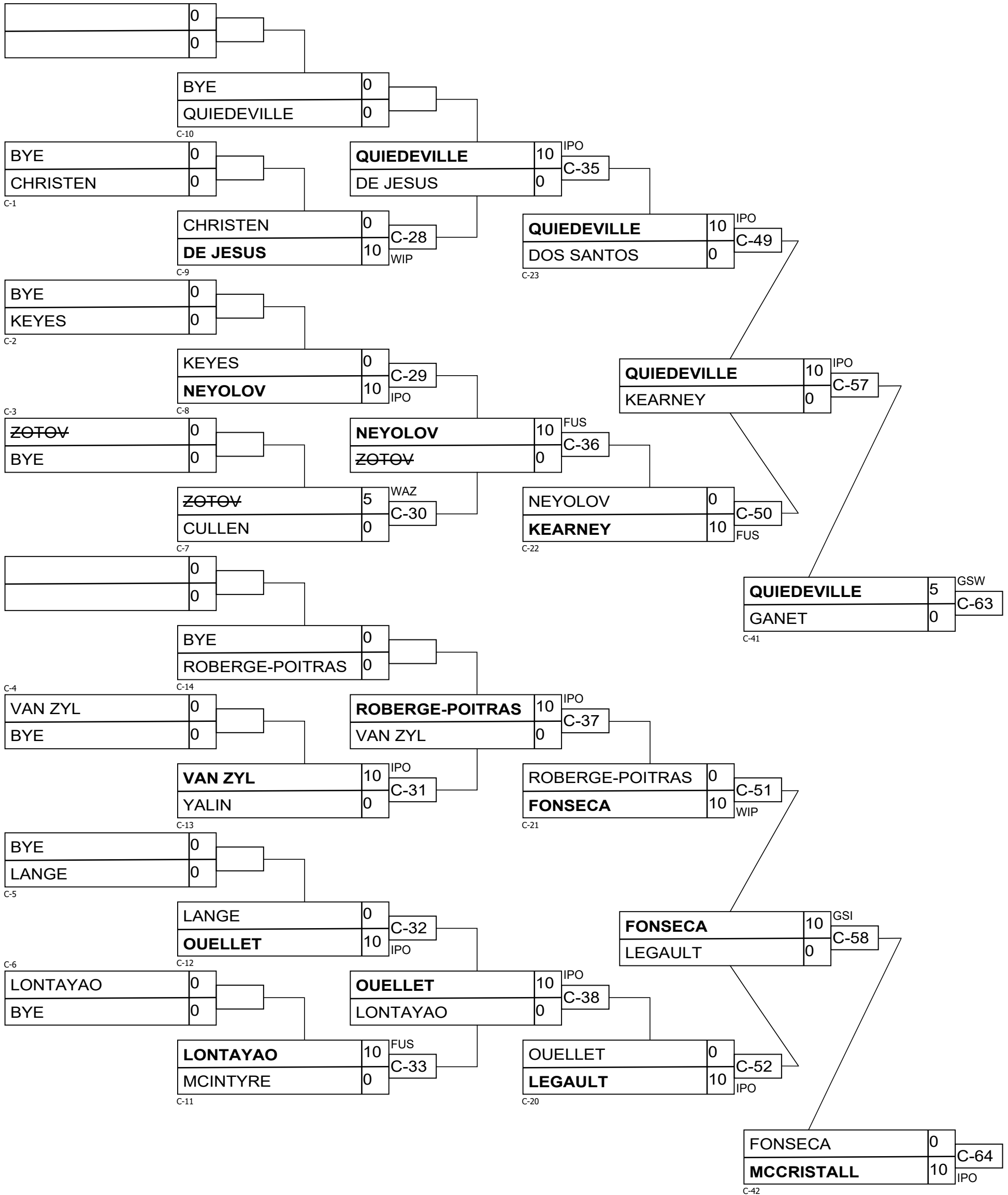

U21M -73kg

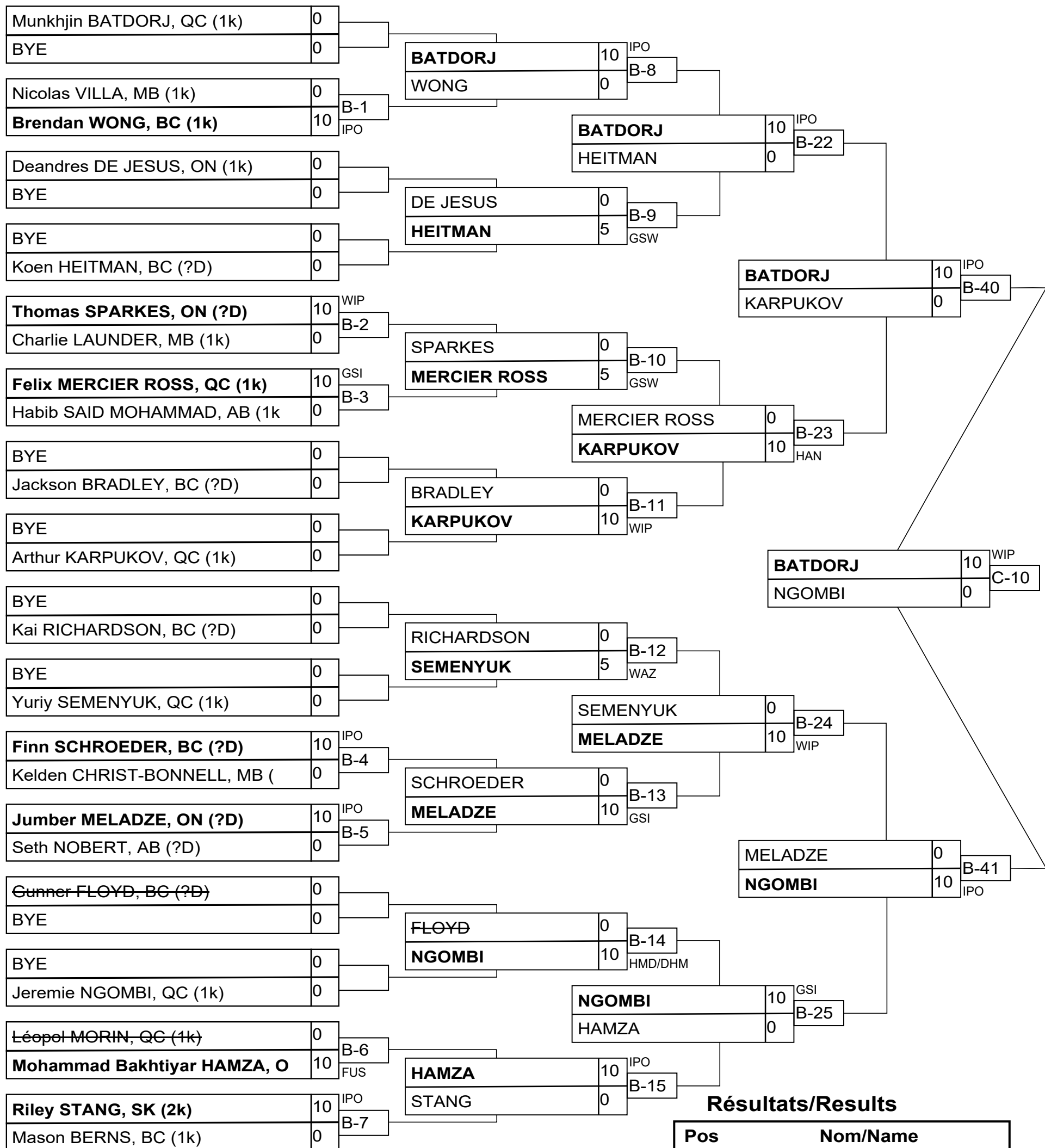

U21M -73kg

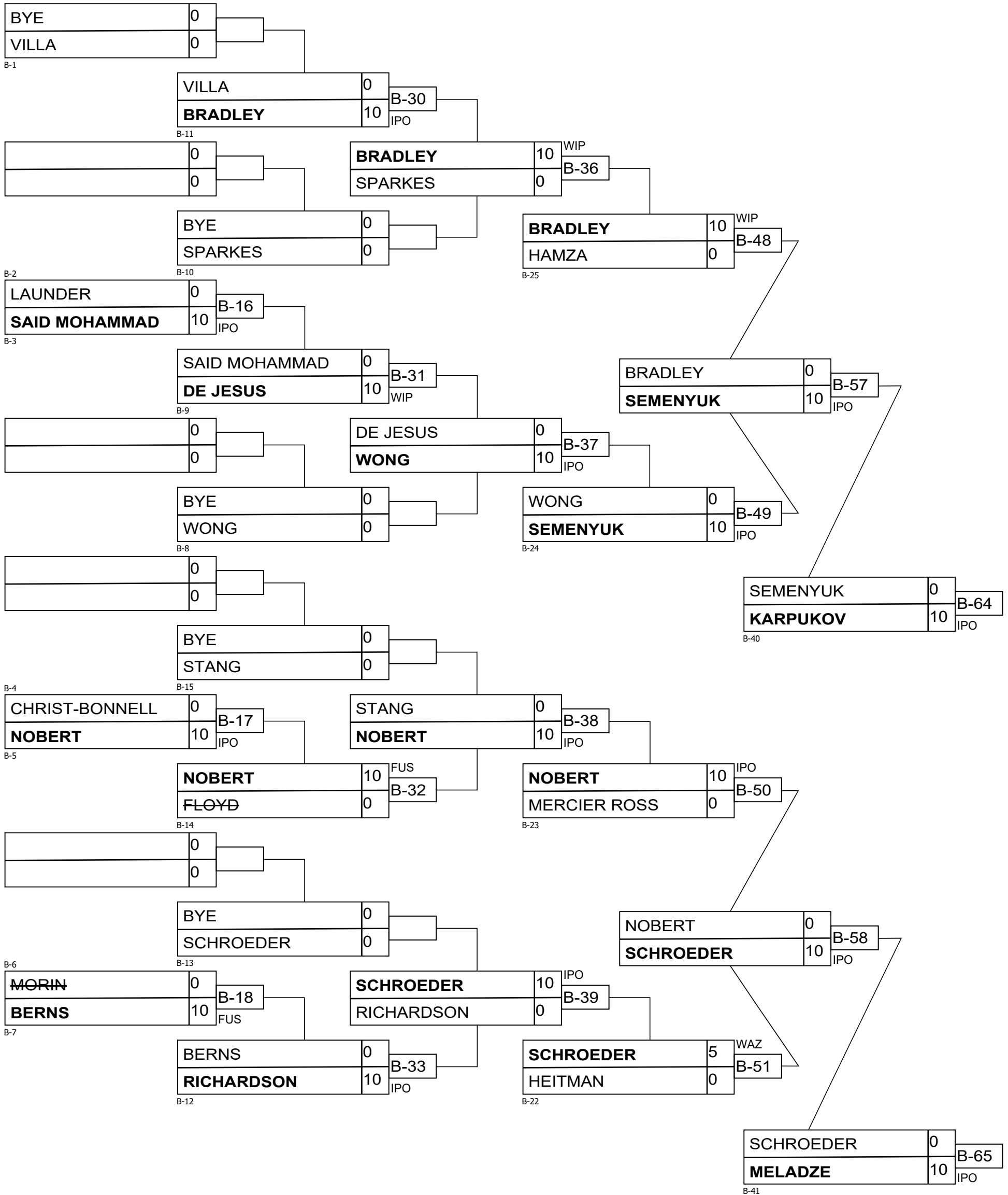

U21M -81kg

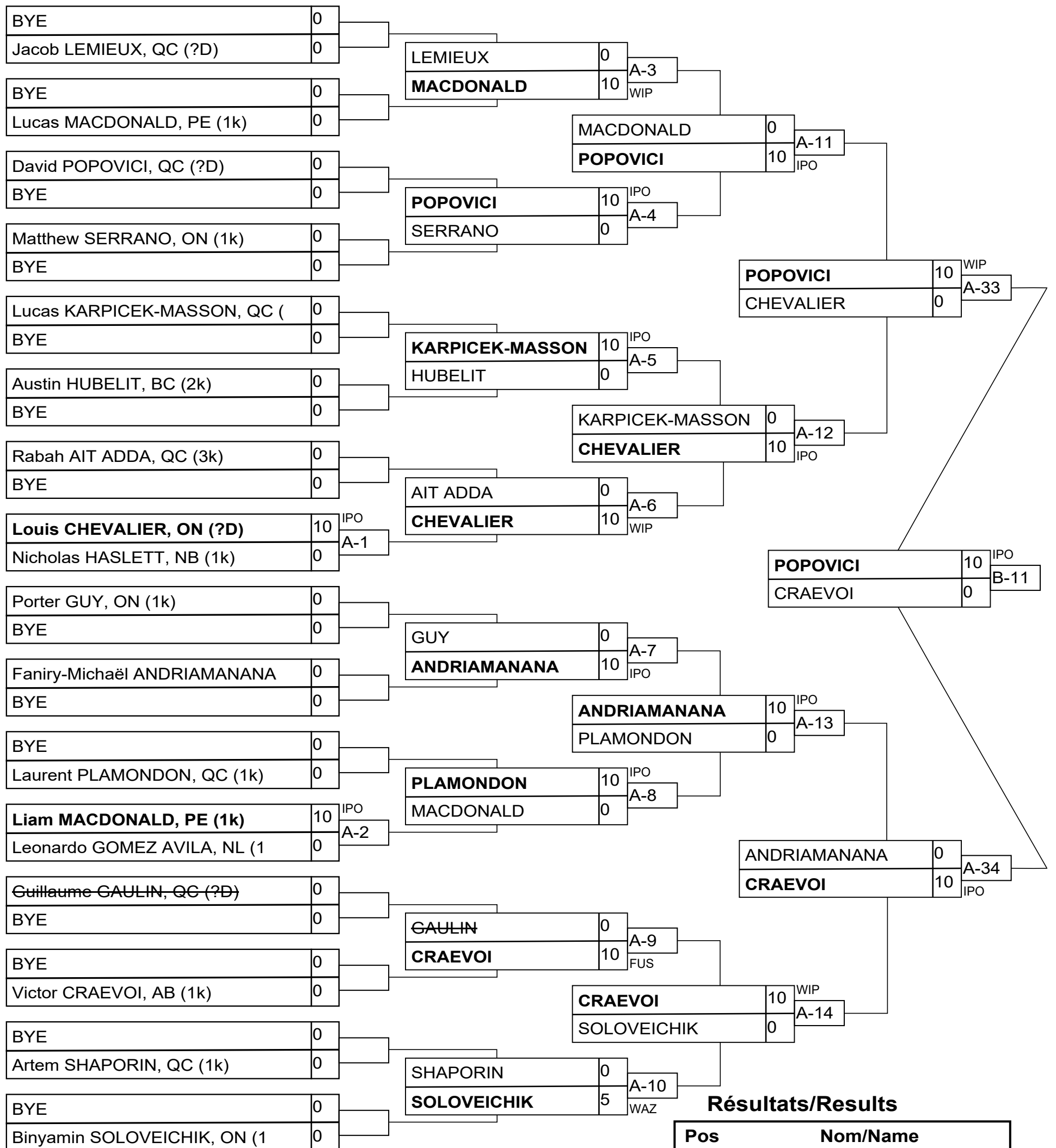

U21M -81kg

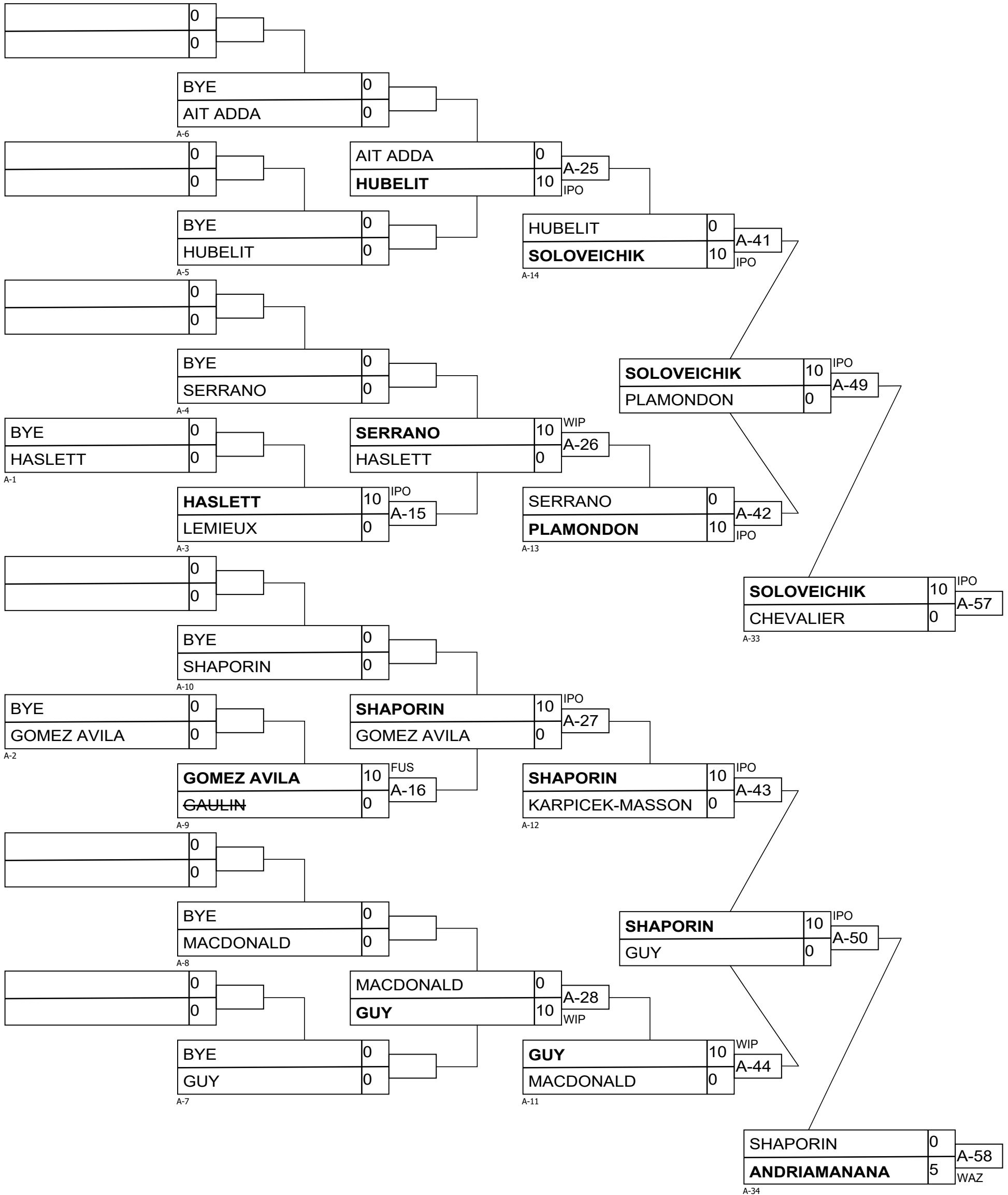

U21M -90kg

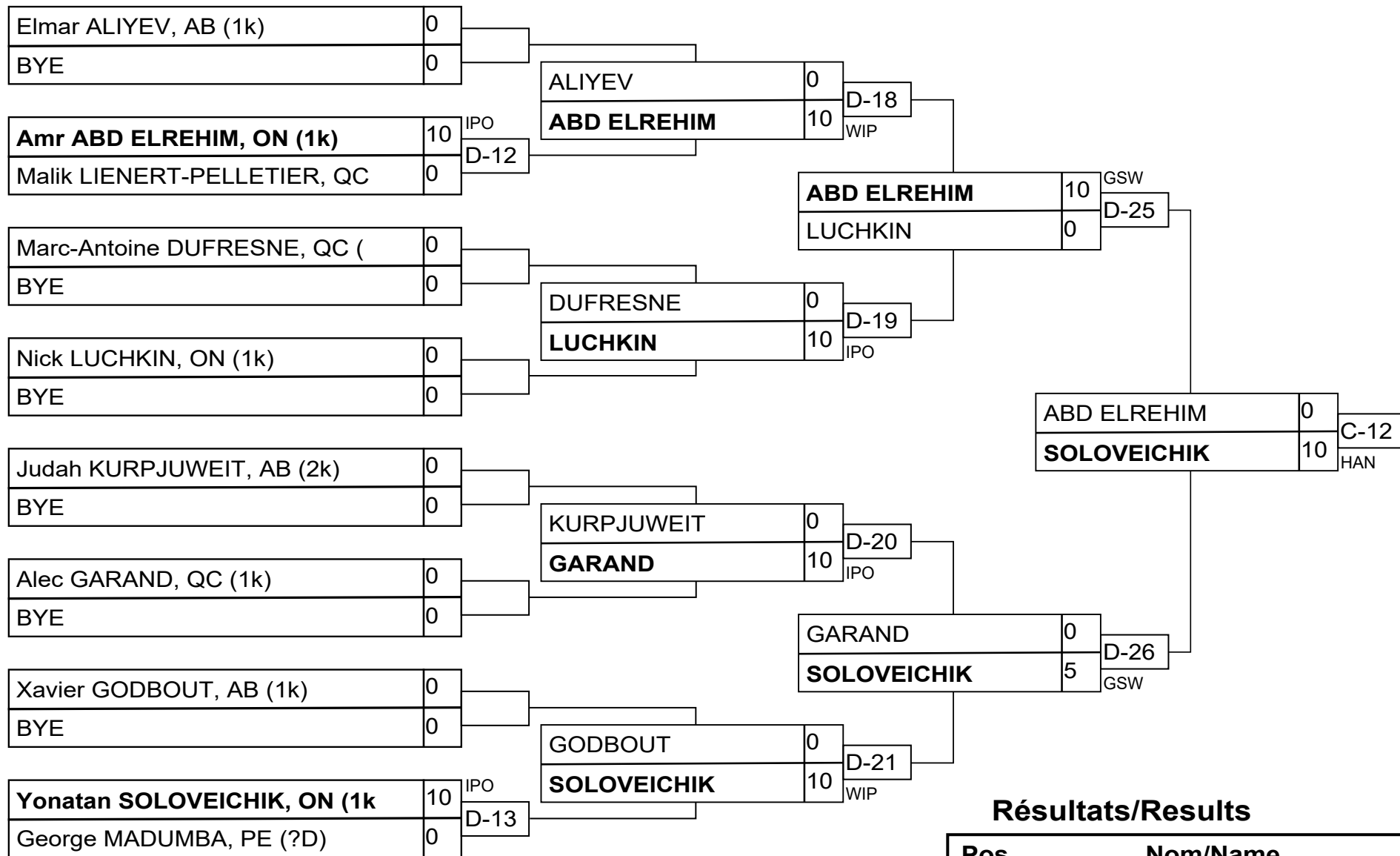

Résultats/Results

Pos	Nom/Name
1	Yonatan SOLOVEICHIK, ON
2	Amr ABD ELREHIM, ON (1k)
3	Nick LUCHKIN, ON (1k)
3	Alec GARAND, QC (1k)

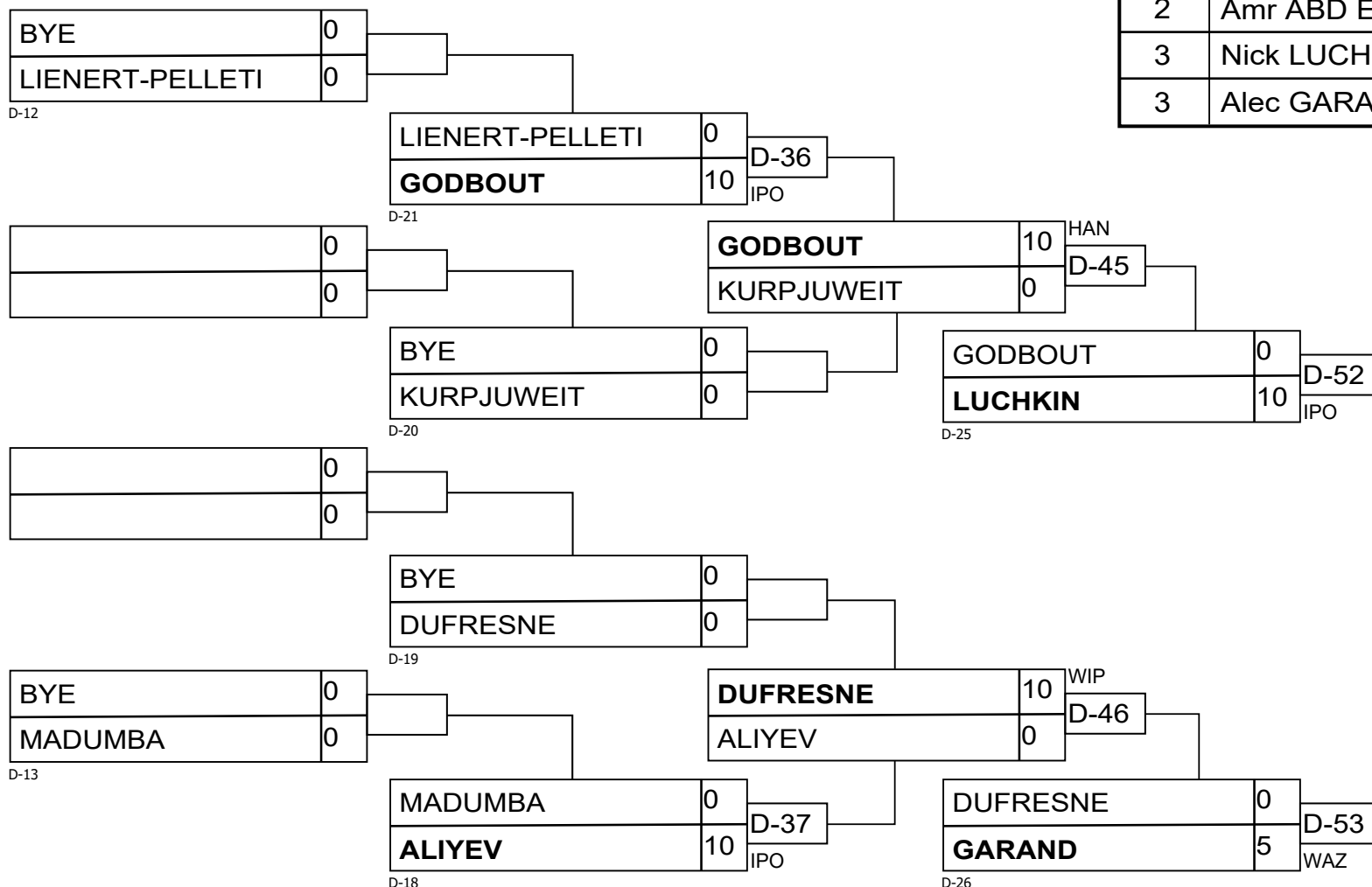

U21M +100kg

Compétiteurs/Competitors

#	Nom/Name	Grade	Club	1	2	1	2	1	2	G/W	Pts	Pos
1	Nick CROSS	1k	QC	XX	10	XX	10	XX		2	20	1
2	Abel VELASQUEZ KASAP	2k	BC		XX		XX		XX	0	0	2

Matches/Matches

Match	Blanc/White			Bleu/Blue	Rés/Res	Tmp/Tim	Code
C-43	Nick CROSS	1	2	Abel VELASQUEZ KASAP	10 - 0	0:34	IPO
C-53	Abel VELASQUEZ KASAP	2	1	Nick CROSS	0 - 10	2:02	IPO
C-59	Nick CROSS	1	2	Abel VELASQUEZ KASAP			

Résultats/Results

Pos	Nom/Name
1	Nick CROSS, QC