

Senior Adv Women -48kg

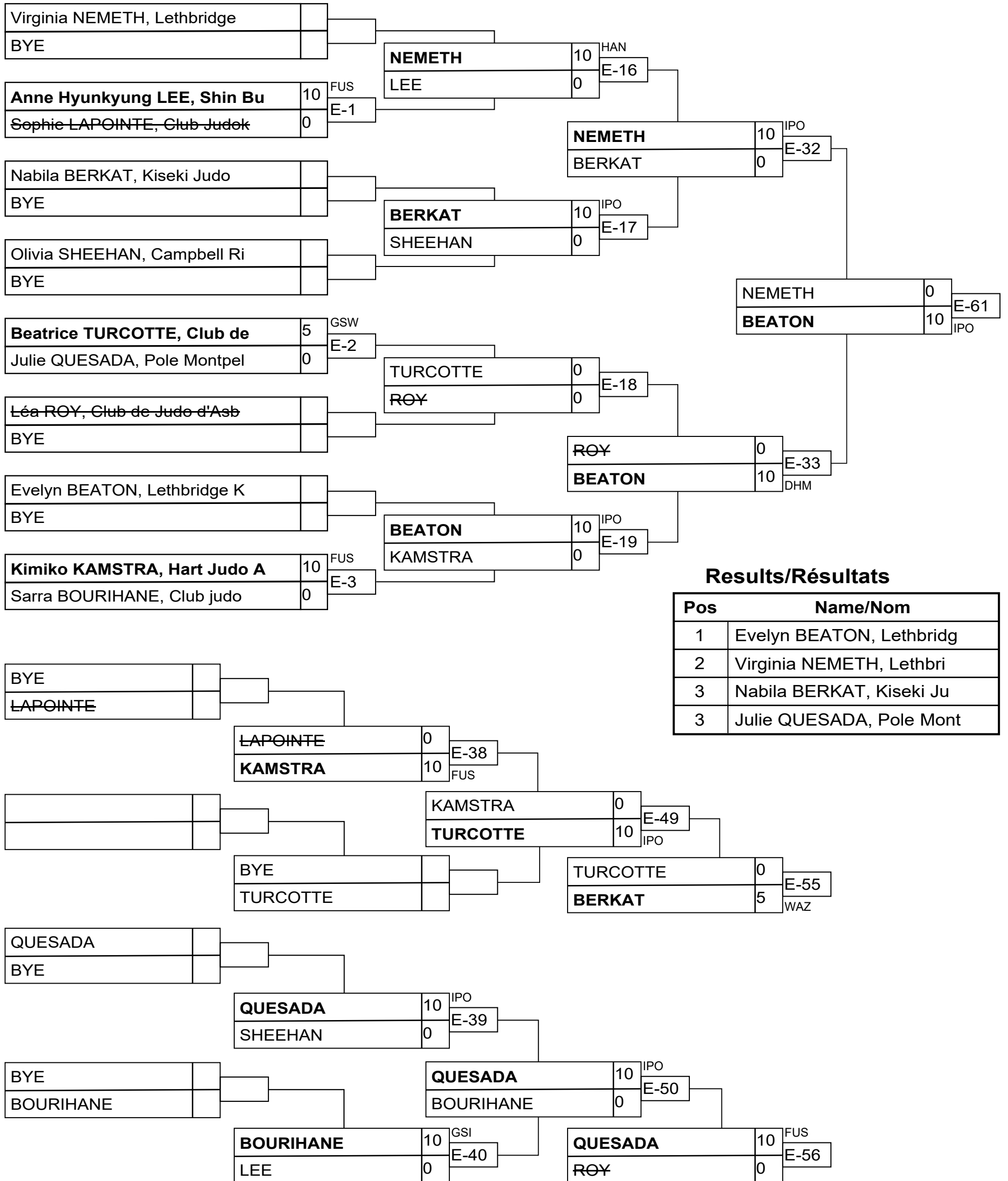

Senior Adv Women -52kg

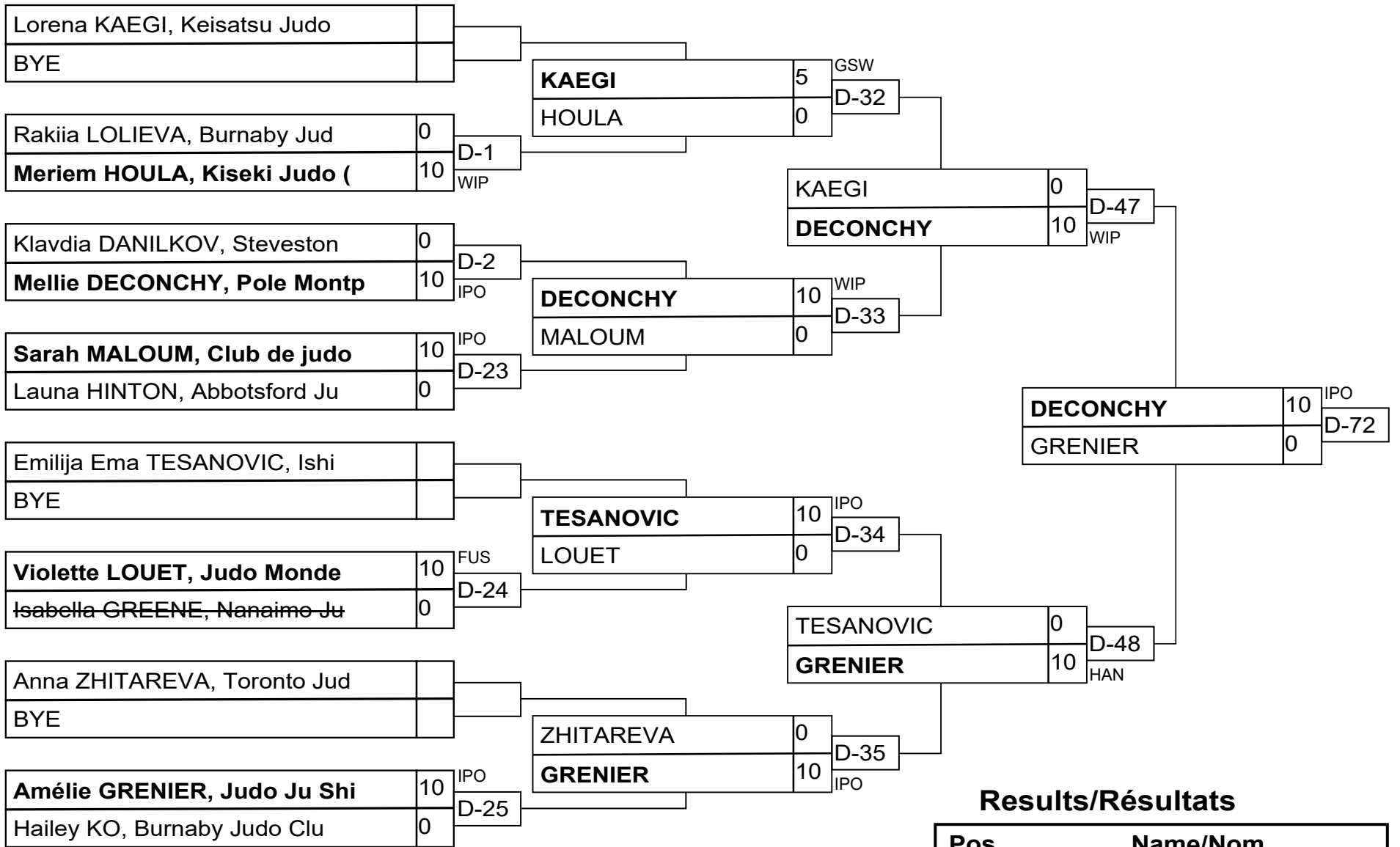

Results/Résultats

Pos	Name/Nom
1	Mellie DECONCHY, Pole Mo
2	Amélie GRENIER, Judo Ju
3	Lorena KAEGI, Keisatsu J
3	Emilija Ema TESANOVIC, I

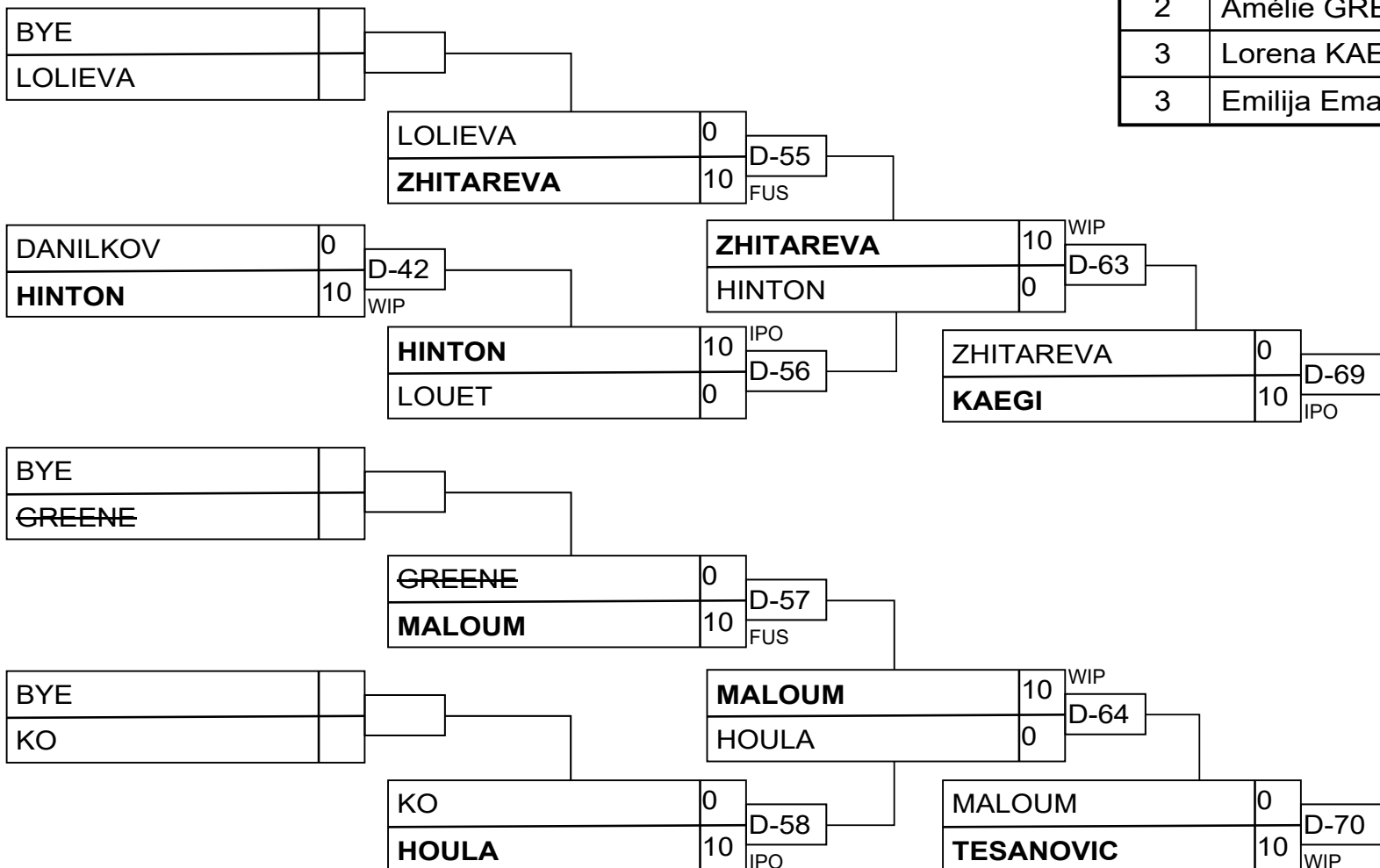

Senior Adv Women -57kg

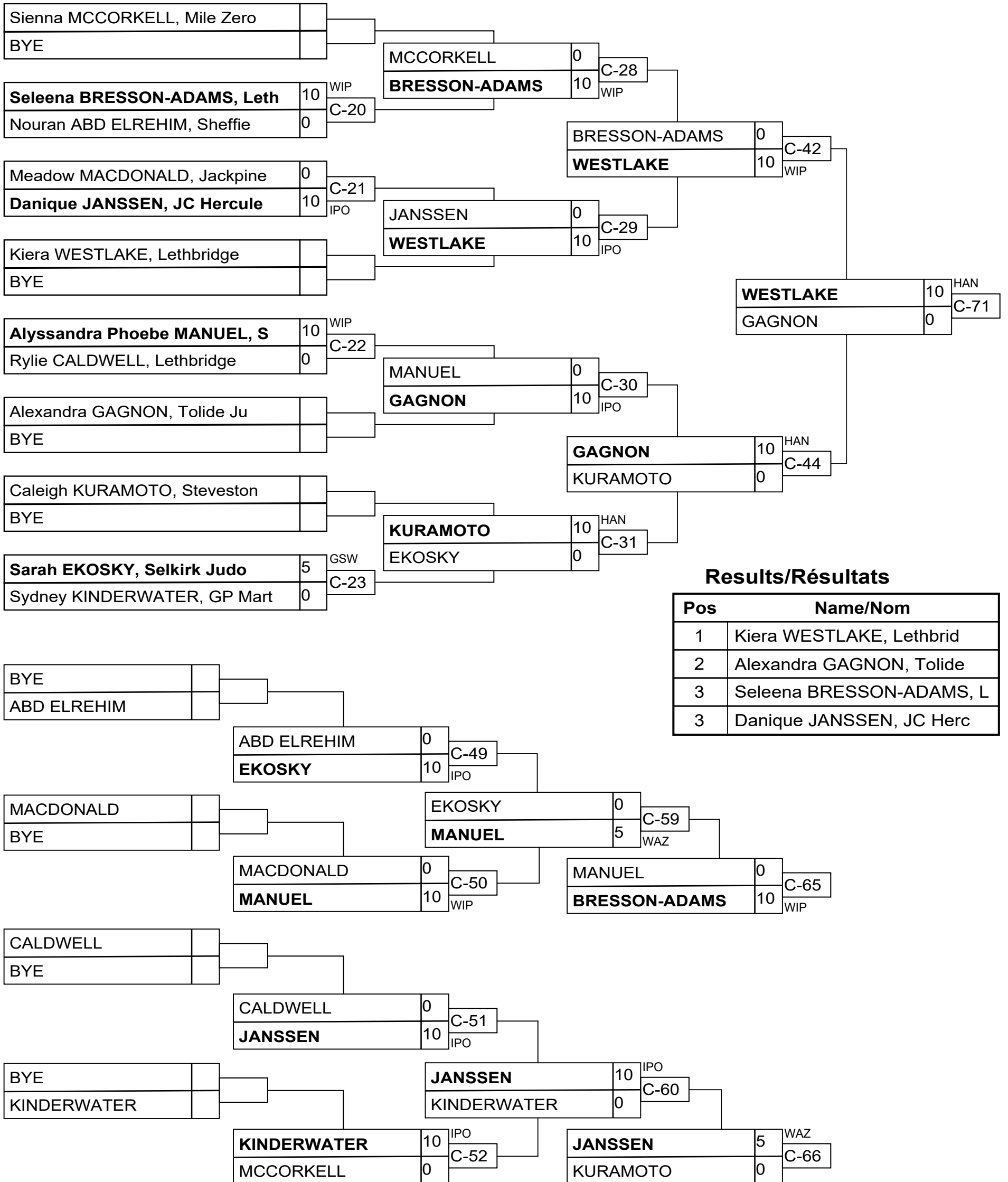

Results/Résultats

Pos	Name/Nom
1	Kiera WESTLAKE, Lethbrid
2	Alexandra GAGNON, Tolide
3	Seleena BRESSON-ADAMS, L
3	Danique JANSSEN, JC Herc

Senior Adv Women -63kg

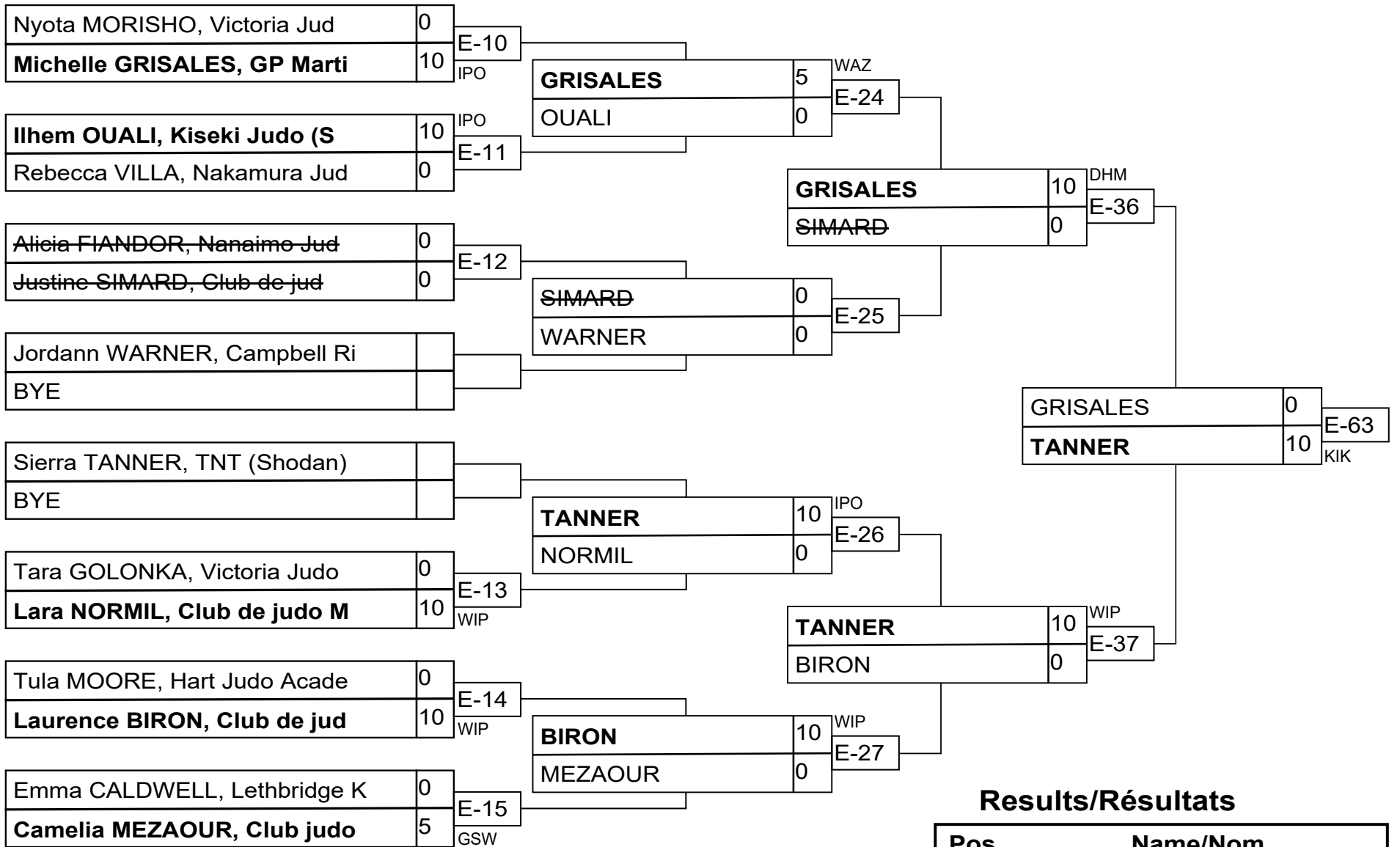

Results/Résultats

Pos	Name/Nom
1	Sierra TANNER, TNT (Shod
2	Michelle GRISALES, GP Ma
3	Lara NORMIL, Club de jud
3	Laurence BIRON, Club de

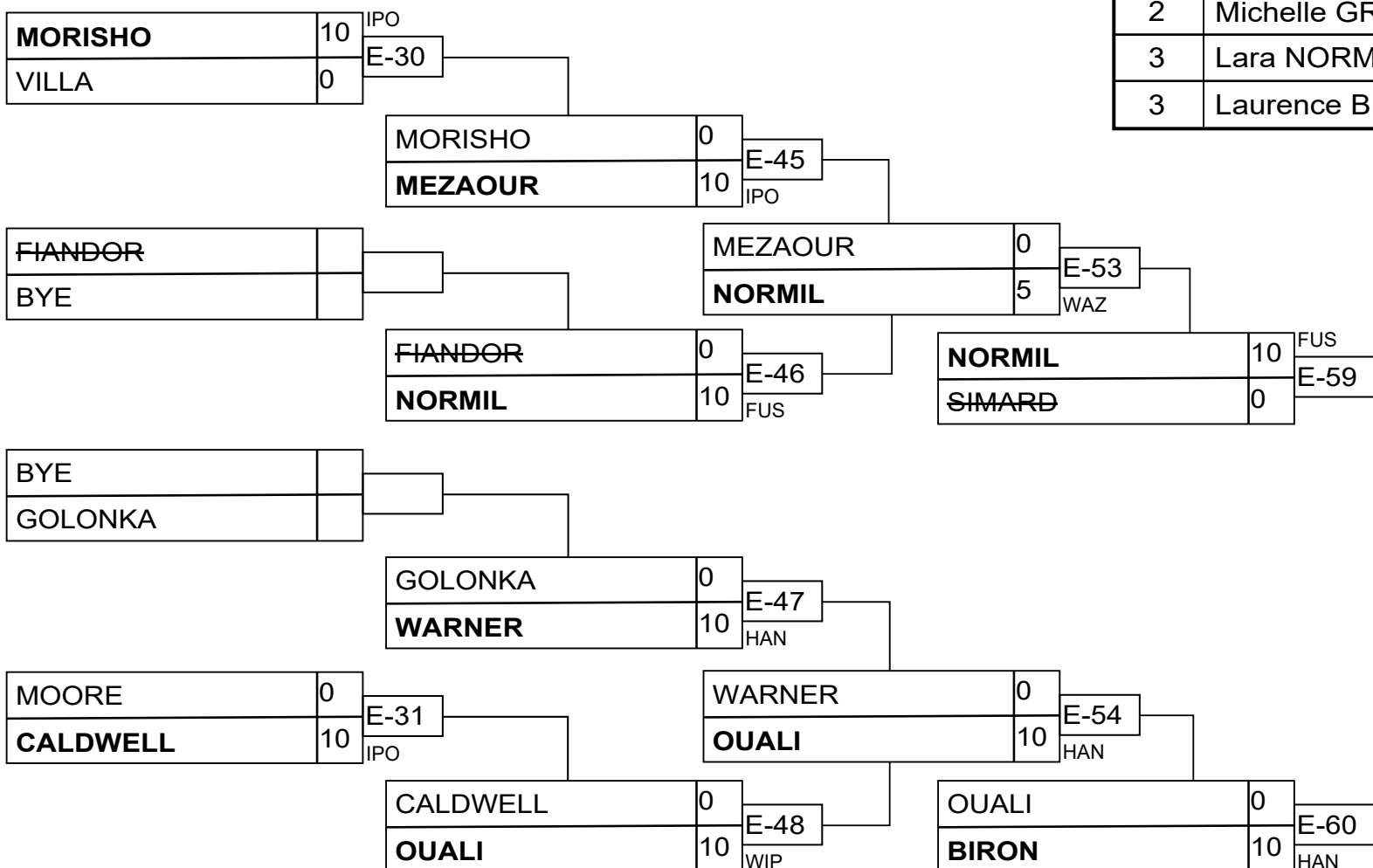

Senior Adv Women -70kg

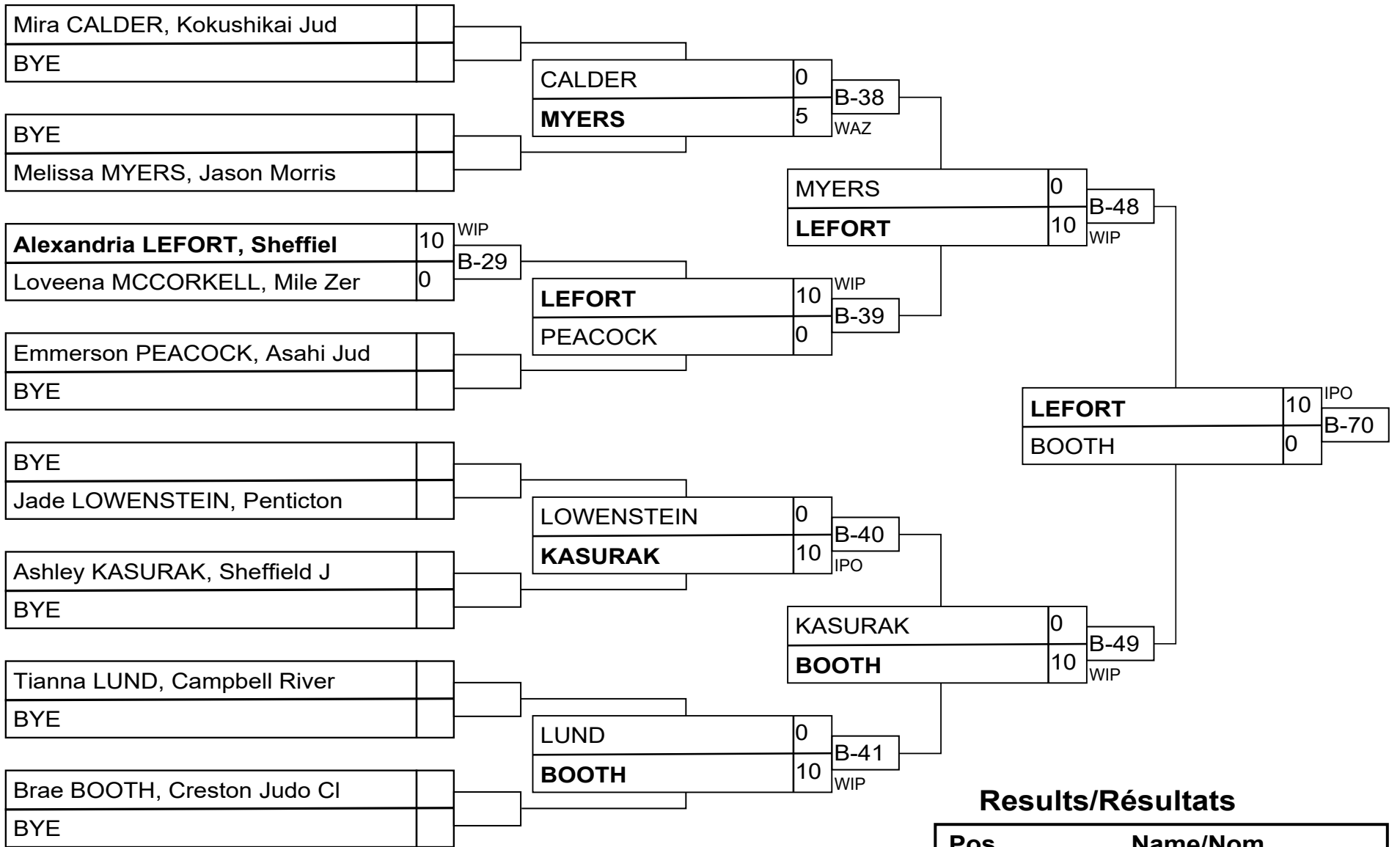

Results/Résultats

Pos	Name/Nom
1	Alexandria LEFORT, Sheff
2	Brae BOOTH, Creston Judo
3	Melissa MYERS, Jason Mor
3	Mira CALDER, Kokushikai

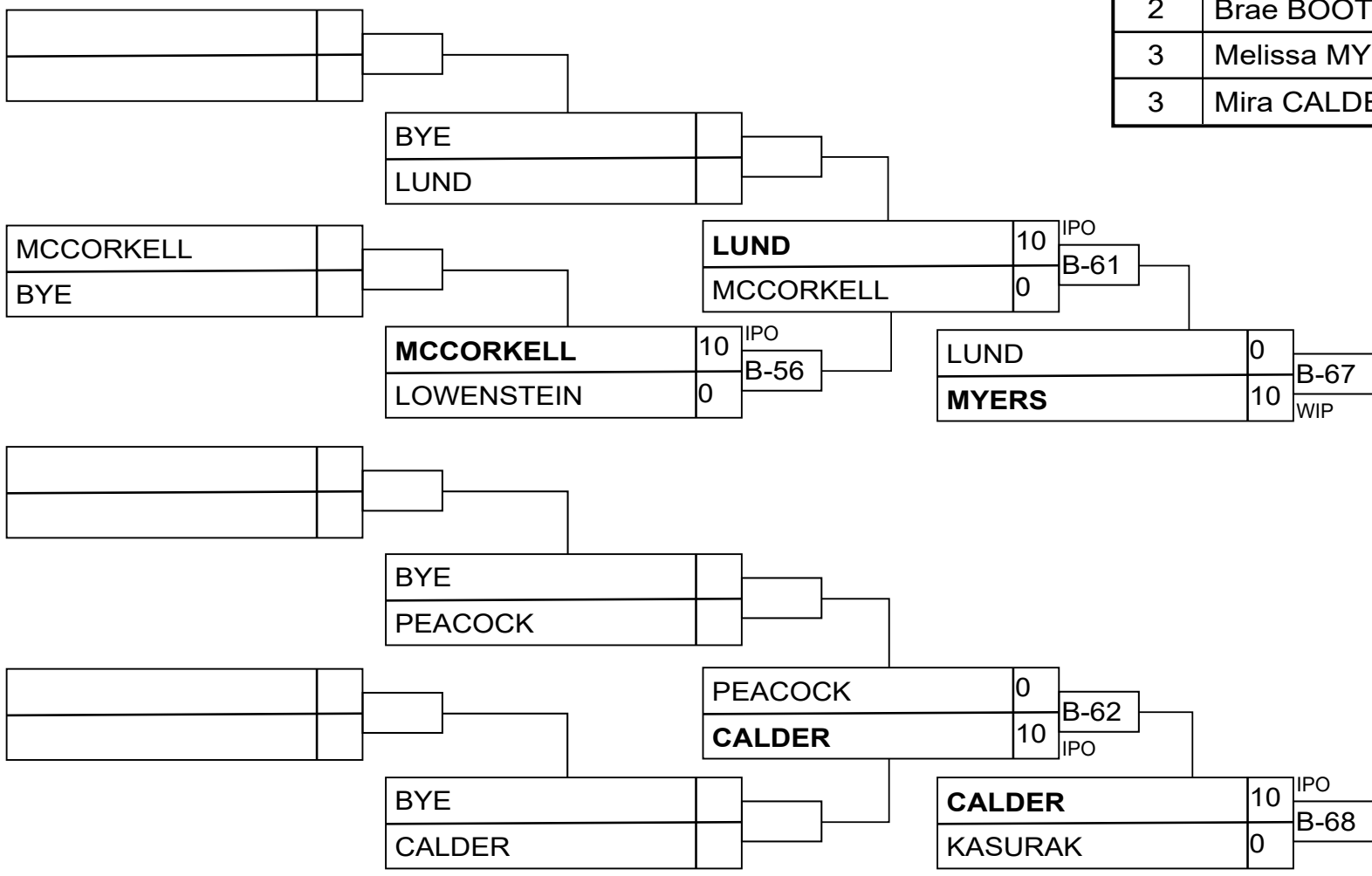

Senior Adv Women -78kg

Competitors/Compétiteurs A

#	Name/Nom	Grade	Club	1	2	3	W/G	Pts	Pos
1	Bishop SOMMERFELD	Shodan	Regina Y	XX	10		1	10	2
2	Anna SHI	Brown	University Of Toronto Ju		XX		0	0	3
3	Shianne GRONEN	Shodan	Lethbridge Kyodokan Judo	10	10	XX	2	20	1

Pool A

Match	White/Blanc	Blue/Bleu	Res/Rés	Tim/Tmp	Code
C-47	Bishop SOMMERFELD 1 2	Anna SHI	10 - 0	0:33	WIP
C-57	Bishop SOMMERFELD 1 3	Shianne GRONEN	0 - 10	0:40	WIP
C-63	Anna SHI 2 3	Shianne GRONEN	0 - 10	0:47	IPO

Competitors/Compétiteurs B

#	Name/Nom	Grade	Club	4	5	6	W/G	Pts	Pos
4	Nicole STOUT	Shodan	Jason Morris Judo Center	XX	10	10	2	20	1
5	Annabelle DARLOW	Shodan	Lethbridge Kyodokan Judo		XX		0	0	3
6	Josie-Anne SYNOTT	Shodan	Académie de Judo de Sept		10	XX	1	10	2

Pool B

Match	White/Blanc	Blue/Bleu	Res/Rés	Tim/Tmp	Code
C-48	Nicole STOUT 4 5	Annabelle DARLOW	10 - 0	0:21	IPO
C-58	Nicole STOUT 4 6	Josie-Anne SYNOTT	10 - 0	0:25	IPO
C-64	Annabelle DARLOW 5 6	Josie-Anne SYNOTT	0 - 10	2:30	HAN

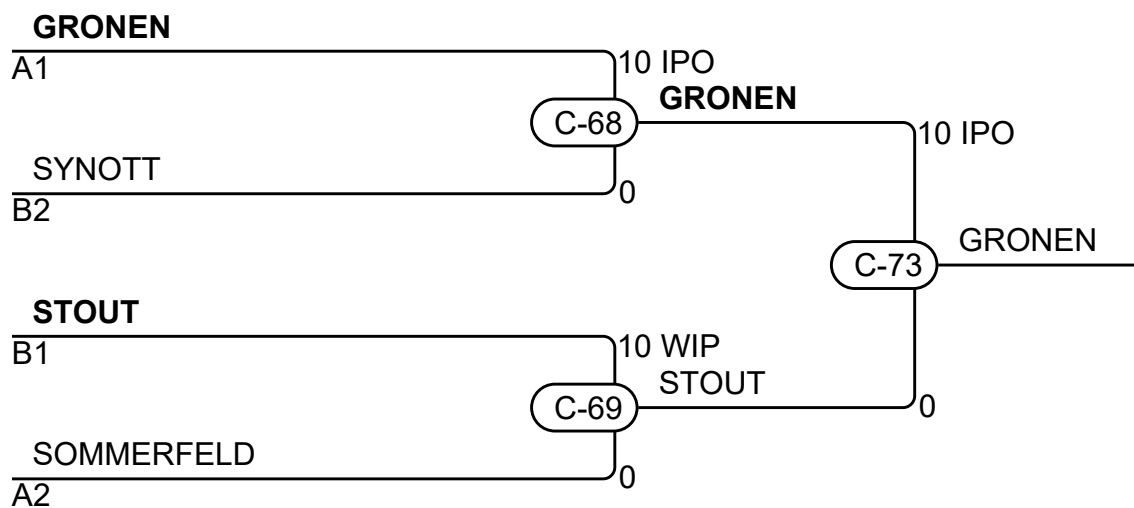

Results/Résultats

Pos	Name/Nom
1	Shianne GRONEN, Lethbridge Kyodokan Judo Club
2	Nicole STOUT, Jason Morris Judo Center
3	Josie-Anne SYNOTT, Académie de Judo de Sept-I
3	Bishop SOMMERFELD, Regina Y

Senior Adv Women +78kg

Competitors/Compétiteurs

#	Name/Nom	Grade	Club	1	2	3	4	W/G	Pts	Pos
1	Amanda MCALPINE	Shodan	Kohbukan-Sisu Judo Club	XX				0	0	4
2	Josephine MORGENROTH	Brown	The Art Of Balance Dojo	10	XX	10	10	3	30	1
3	Jannessa KEAYS	Blue	Saskatoon Ymca Judo Club	10		XX	10	2	20	2
4	Sara DESBIENS	Brown	Judo Ju Shin Kan Laterri	10			XX	1	10	3

Matches/Matches

Match	White/Blanc			Blue/Bleu	Res/Rés	Tim/Tmp	Code
B-50	Amanda MCALPINE	1	2	Josephine MORGENROTH	0 - 10	2:16	WIP
B-51	Jannessa KEAYS	3	4	Sara DESBIENS	10 - 0	0:40	IPO
B-57	Amanda MCALPINE	1	3	Jannessa KEAYS	0 - 10	1:26	WIP
B-58	Josephine MORGENROTH	2	4	Sara DESBIENS	10 - 0	3:20	HAN
B-63	Amanda MCALPINE	1	4	Sara DESBIENS	0 - 10	1:28	WIP
B-64	Josephine MORGENROTH	2	3	Jannessa KEAYS	10 - 0	1:50	WIP

Results/Résultats

Pos	Name/Nom
1	Josephine MORGENROTH, The Art Of Balance Dojo
2	Jannessa KEAYS, Saskatoon Ymca Judo Club
3	Sara DESBIENS, Judo Ju Shin Kan Laterrière

Senior Advanced Men -100kg

Competitors/Compétiteurs

#	Name/Nom	Grade	Club	1	2	3	4	5	W/G	Pts	Pos
1	Terry ST LOUIS	Brown	Sho Jin Judo Club	XX					0	0	5
2	Simon POPOV	Brown	Toronto Judo Kai	10	XX	10	10		3	30	1
3	Nate KEEVE	Shodan	Jason Morris Judo Center	10		XX	10	10	3	30	2
4	Nicholas DORE	Shodan	Takahashi Dojo	10			XX		1	10	4
5	Chris CONNORS	Shodan	Dakota Judo Club	10	10		5	XX	3	25	3

Matches/Matches

Match	White/Blanc			Blue/Bleu	Res/Rés	Tim/Tmp	Code
D-36	Nicholas DORE	4	5	Chris CONNORS	0 - 5	4:00	WAZ
D-37	Terry ST LOUIS	1	2	Simon POPOV	0 - 10	0:16	IPO
D-43	Nate KEEVE	3	4	Nicholas DORE	10 - 0	1:02	WIP
D-44	Terry ST LOUIS	1	5	Chris CONNORS	0 - 10	0:30	IPO
D-49	Simon POPOV	2	3	Nate KEEVE	10 - 0	0:20	IPO
D-50	Terry ST LOUIS	1	4	Nicholas DORE	0 - 10	2:17	WIP
D-59	Nate KEEVE	3	5	Chris CONNORS	10 - 0	0:44	IPO
D-60	Simon POPOV	2	4	Nicholas DORE	10 - 0	1:45	IPO
D-65	Terry ST LOUIS	1	3	Nate KEEVE	0 - 10	0:04	IPO
D-66	Simon POPOV	2	5	Chris CONNORS	0 - 10	2:01	IPO

Results/Résultats

Pos	Name/Nom
1	Simon POPOV, Toronto Judo Kai
2	Nate KEEVE, Jason Morris Judo Center
3	Chris CONNORS, Dakota Judo Club
4	Nicholas DORE, Takahashi Dojo

Senior Advanced Men -60kg

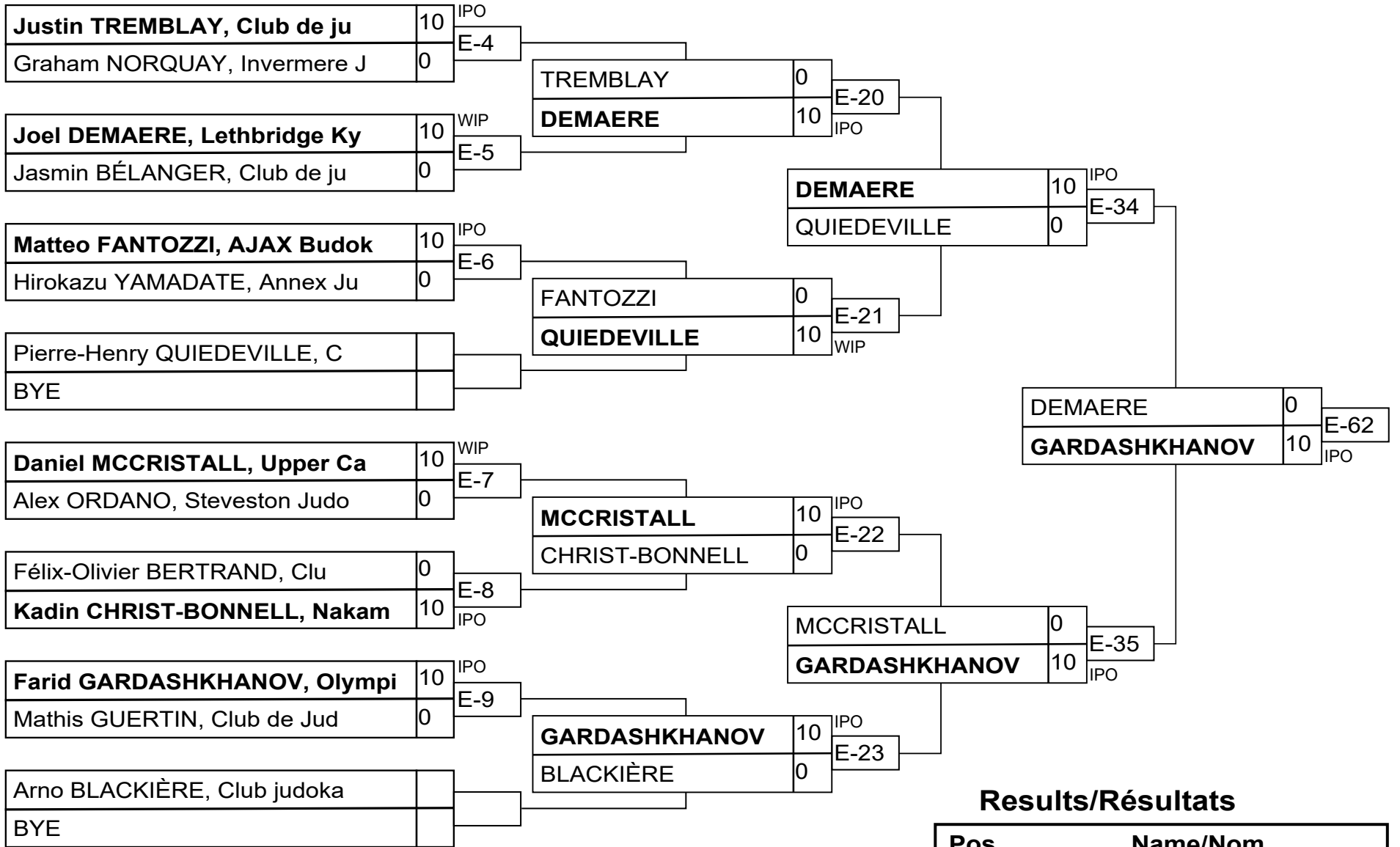

Results/Résultats

Pos	Name/Nom
1	Farid GARDASHKHANOV, Oly
2	Joel DEMAERE, Lethbridge
3	Arno BLACKIÈRE, Club jud
3	Matteo FANTOZZI, AJAX Bu

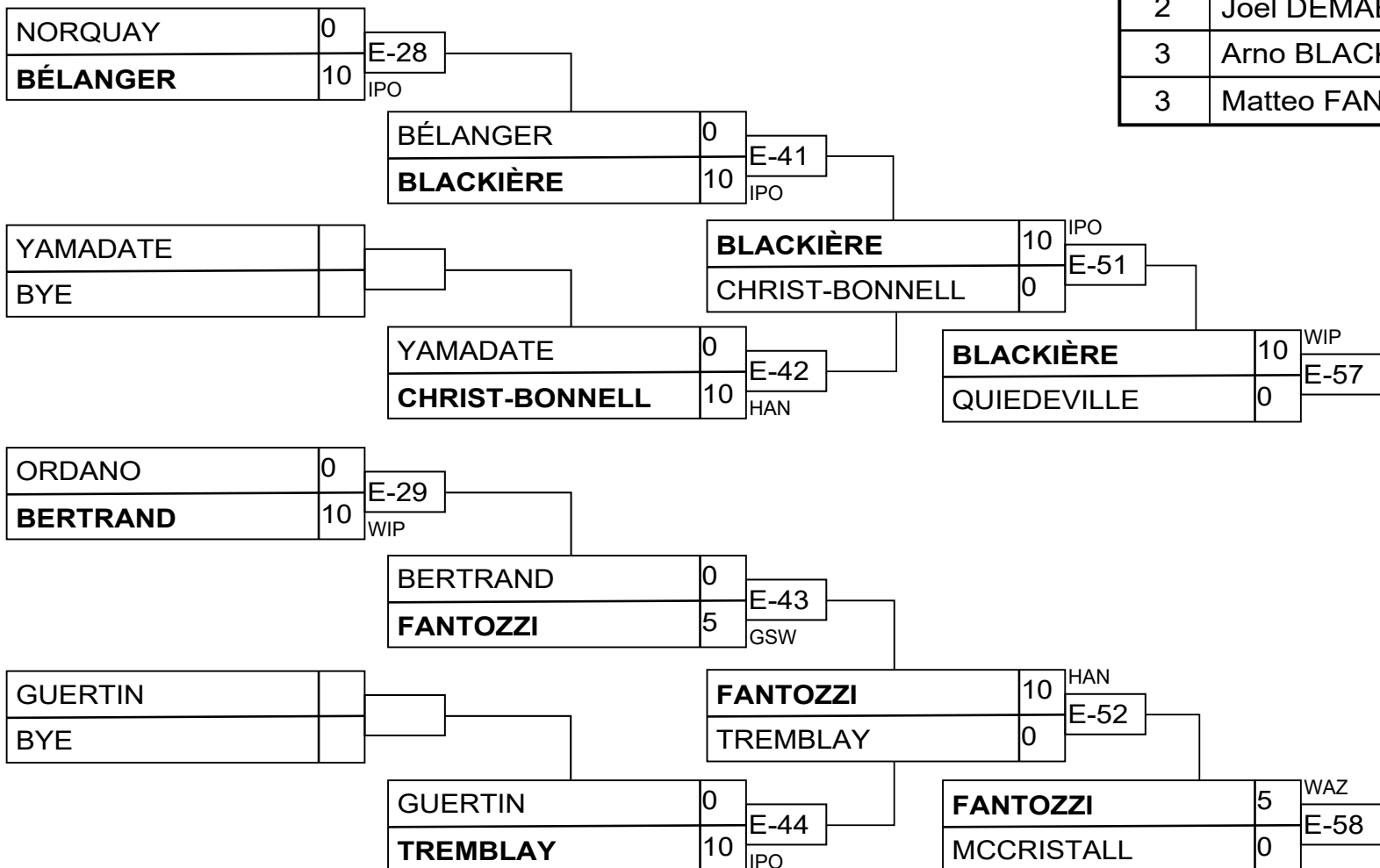

Senior Advanced Men -66kg

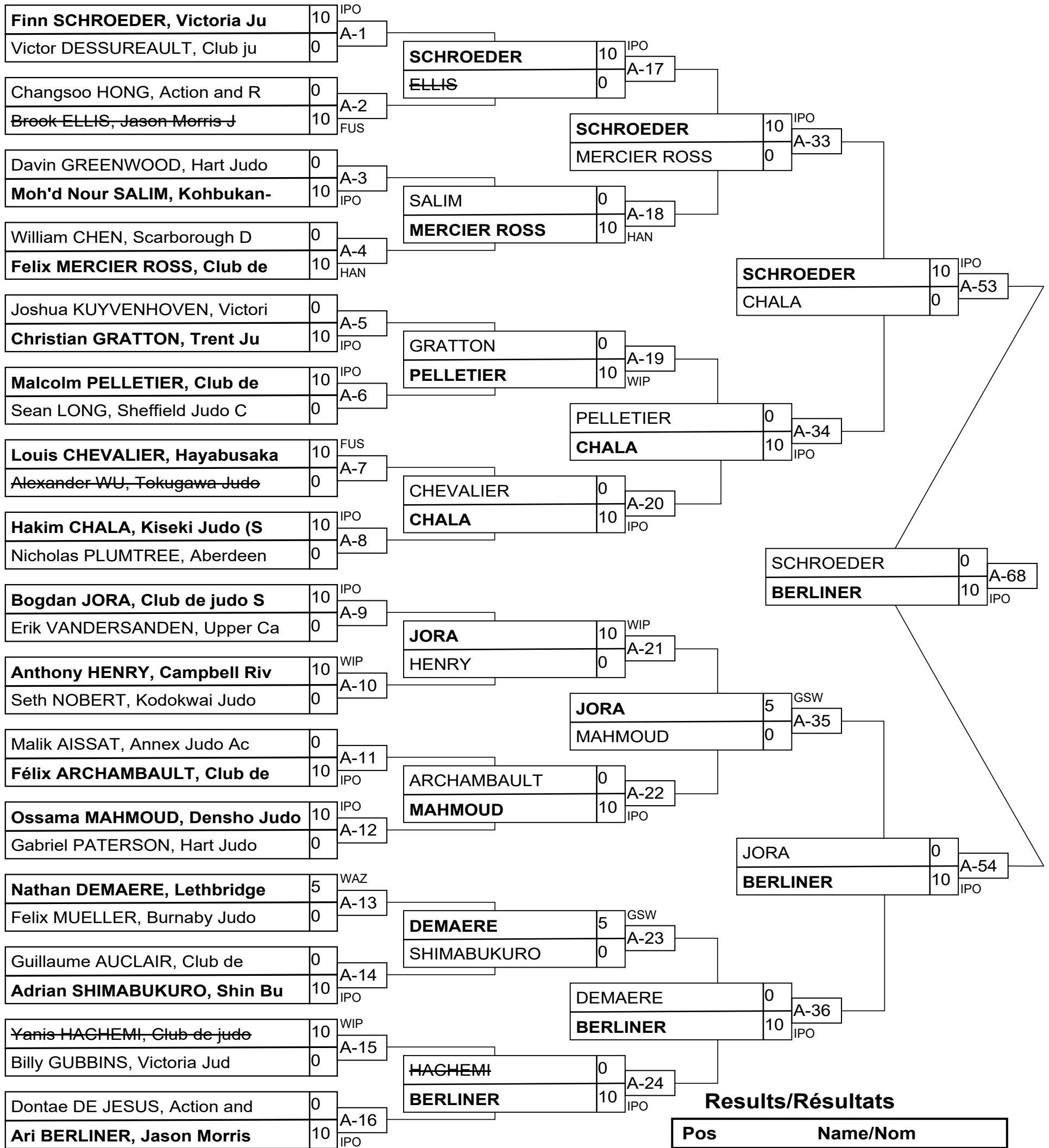

Results/Résultats

Pos	Name/Nom
1	Ari BERLINER, Jason Morr
2	Finn SCHROEDER, Victoria
3	Ossama MAHMOUD, Densho J
3	Bogdan JORA, Club de jud

Senior Advanced Men -73kg

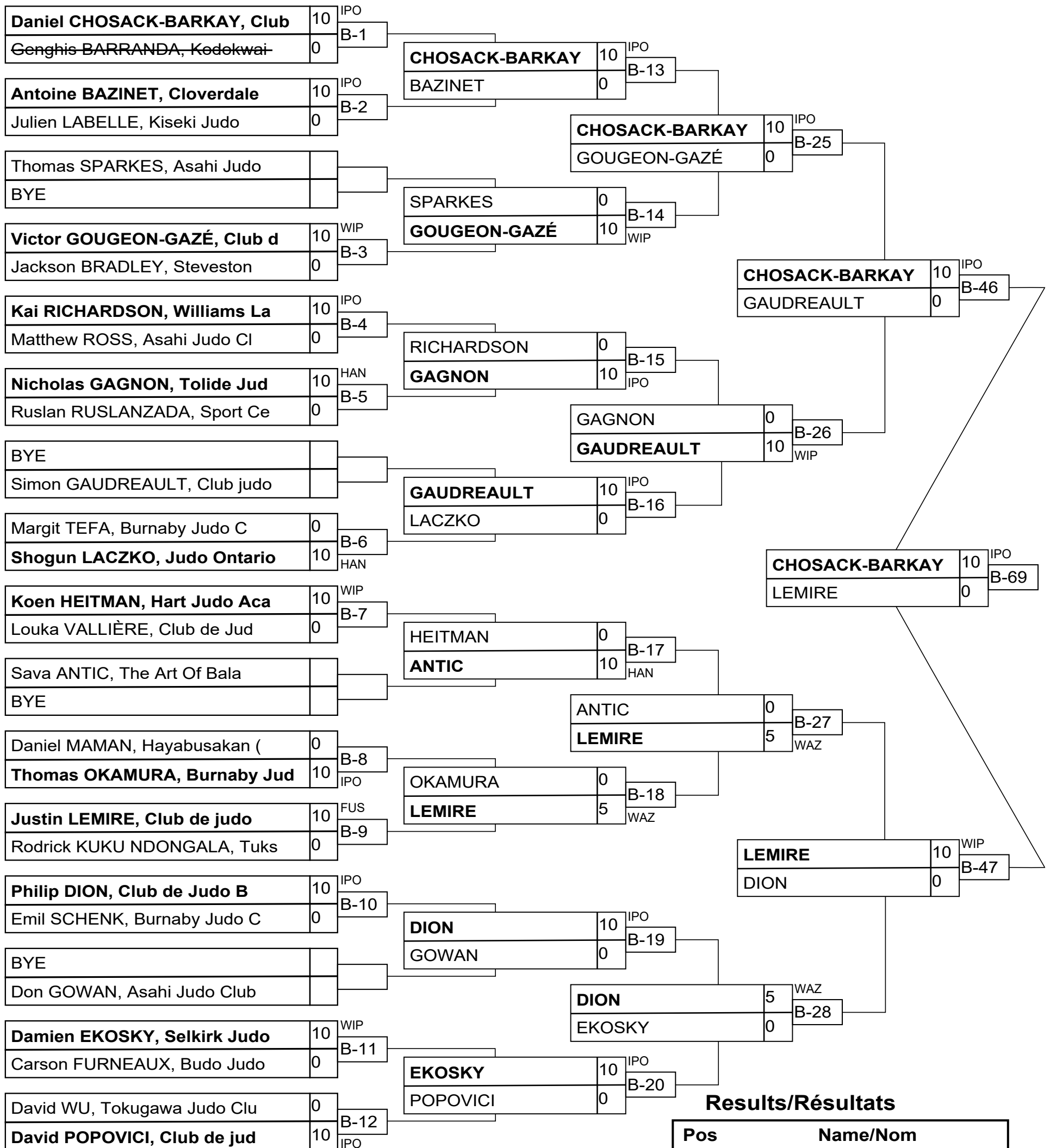

Results/Résultats

Pos	Name/Nom
1	Daniel CHOSACK-BARKAY, C
2	Justin LEMIRE, Club de j
3	Simon GAUDREULT, Club j
3	Victor GOUGEON-GAZÉ, Clu

Senior Advanced Men -73kg

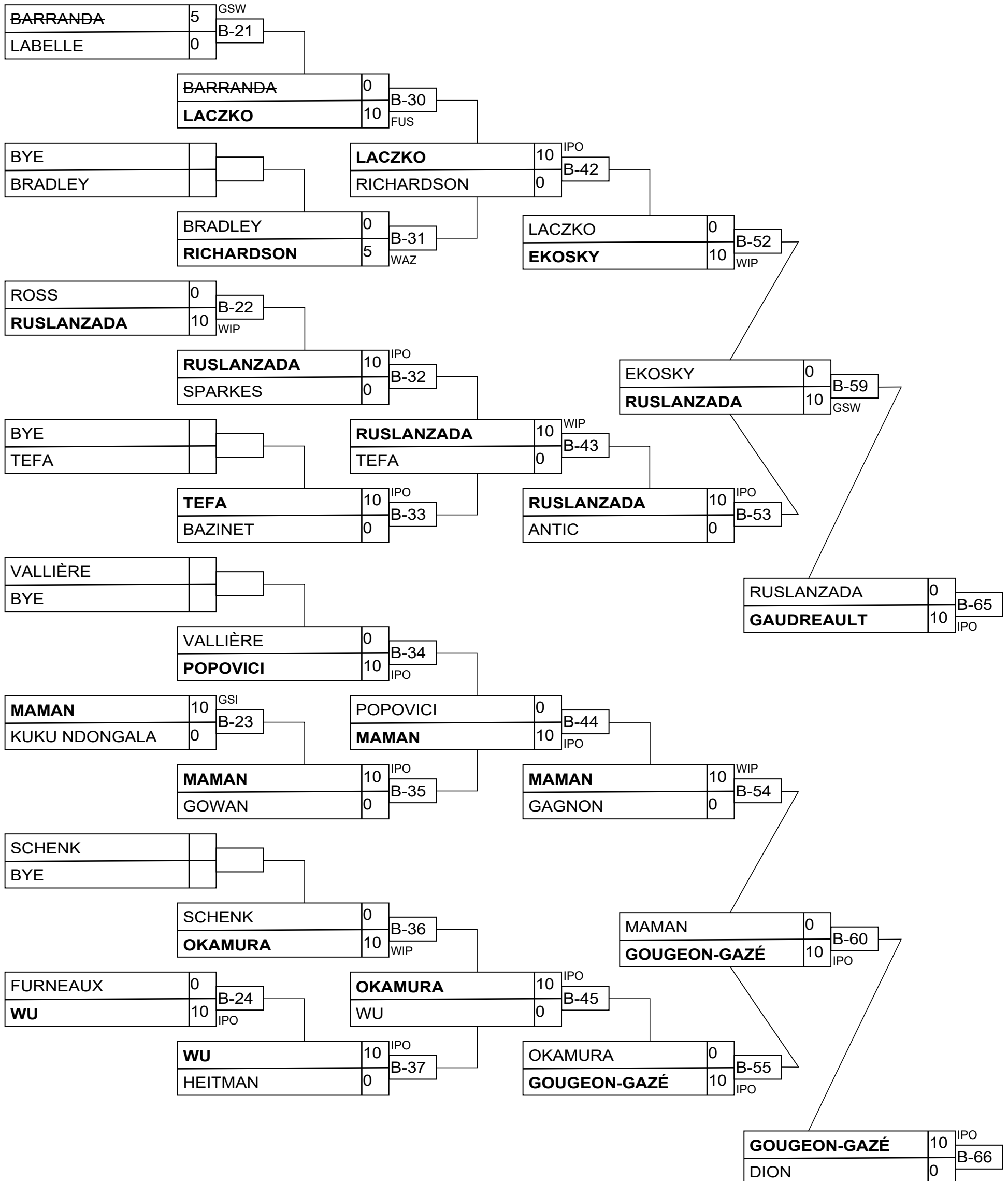

Senior Advanced Men -81kg

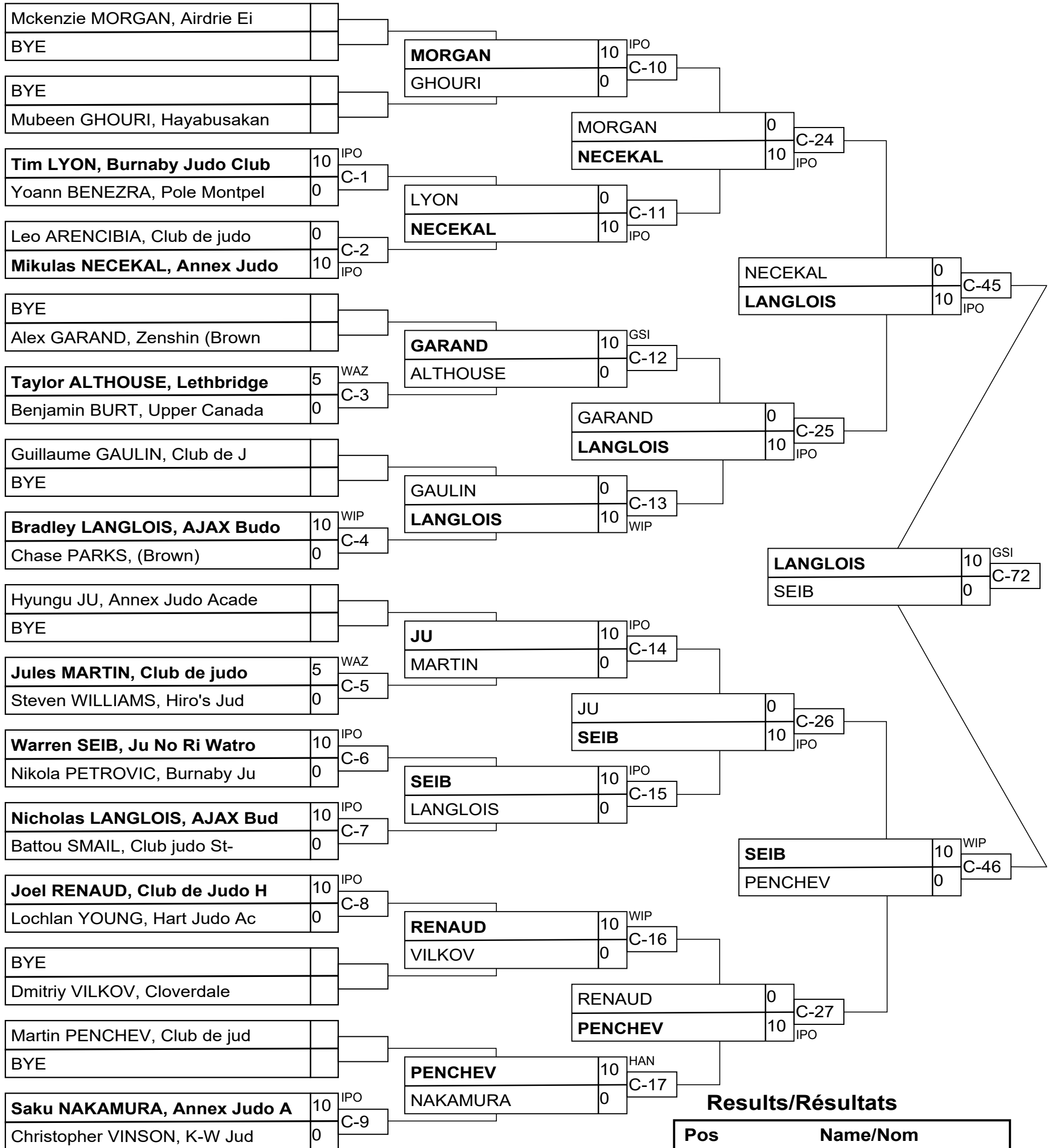

Results/Résultats

Pos	Name/Nom
1	Bradley LANGLOIS, AJAX B
2	Warren SEIB, Ju No Ri Wa
3	Yoann BENEZRA, Pole Mont
3	Martin PENCHEV, Club de

Senior Advanced Men -81kg

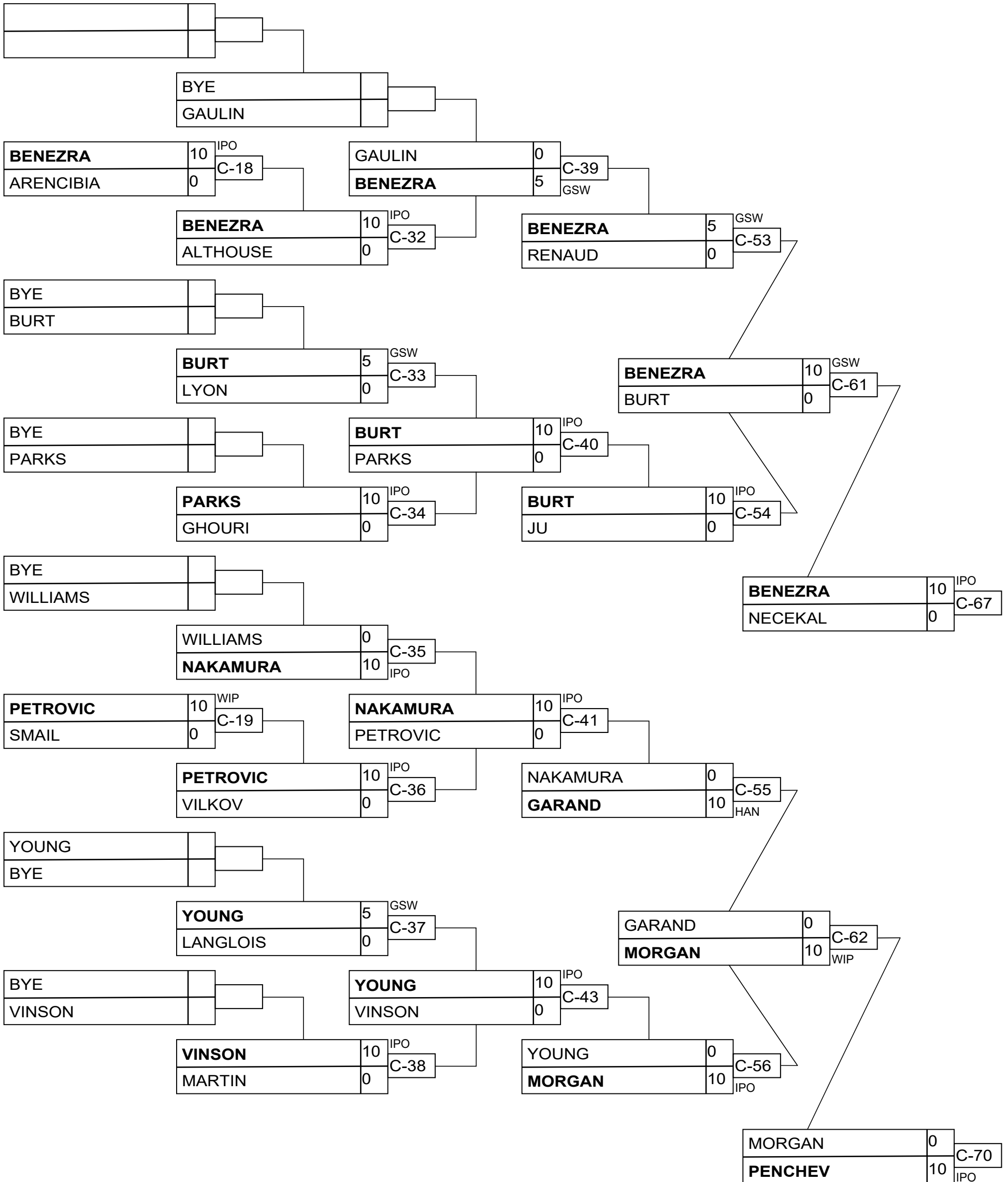

Senior Advanced Men -90kg

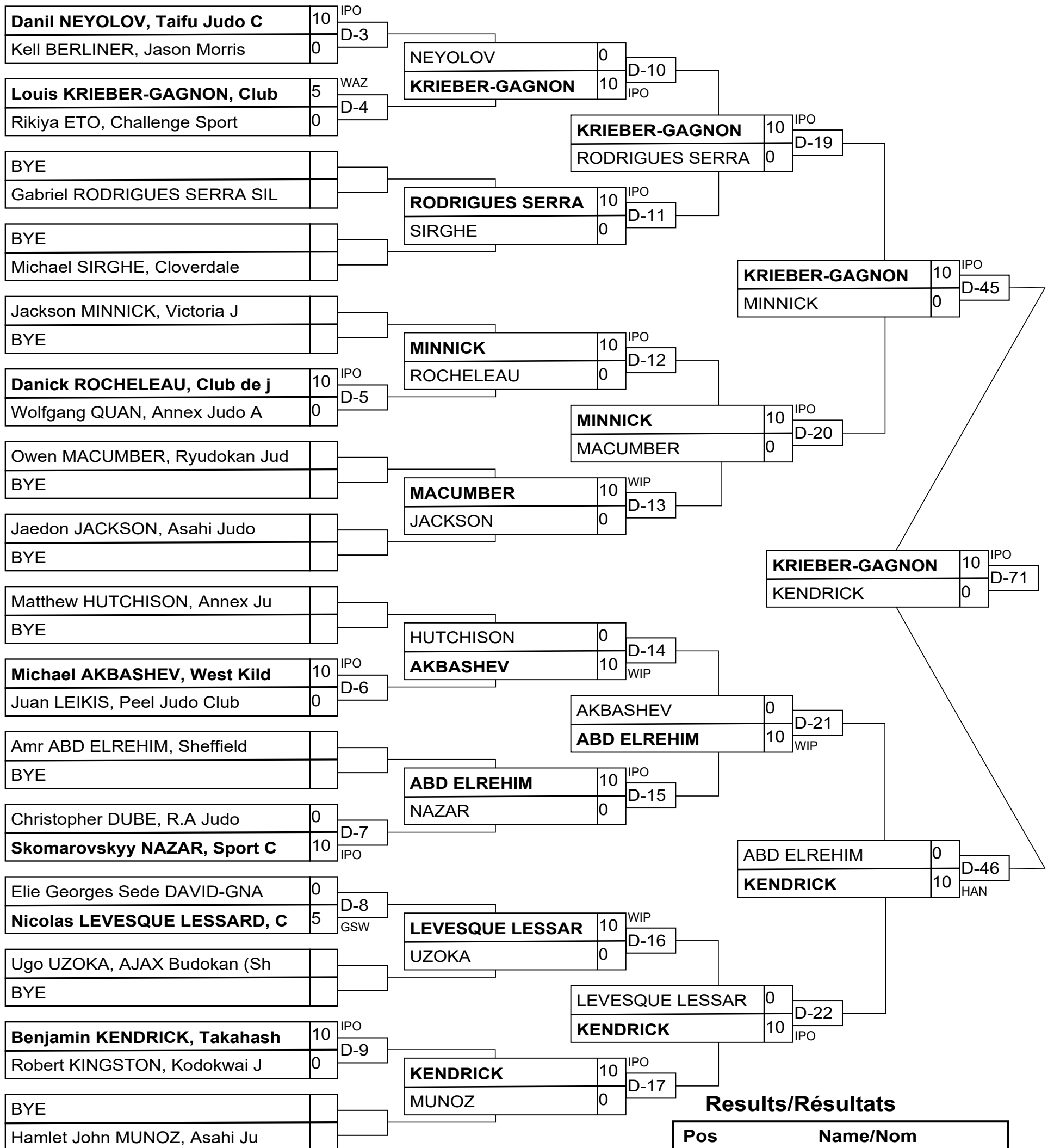

Results/Résultats

Pos	Name/Nom
1	Louis KRIEBER-GAGNON, CI
2	Benjamin KENDRICK, Takah
3	Rikiya ETO, Challenge Sp
3	Amr ABD ELREHIM, Sheffie

Senior Advanced Men -90kg

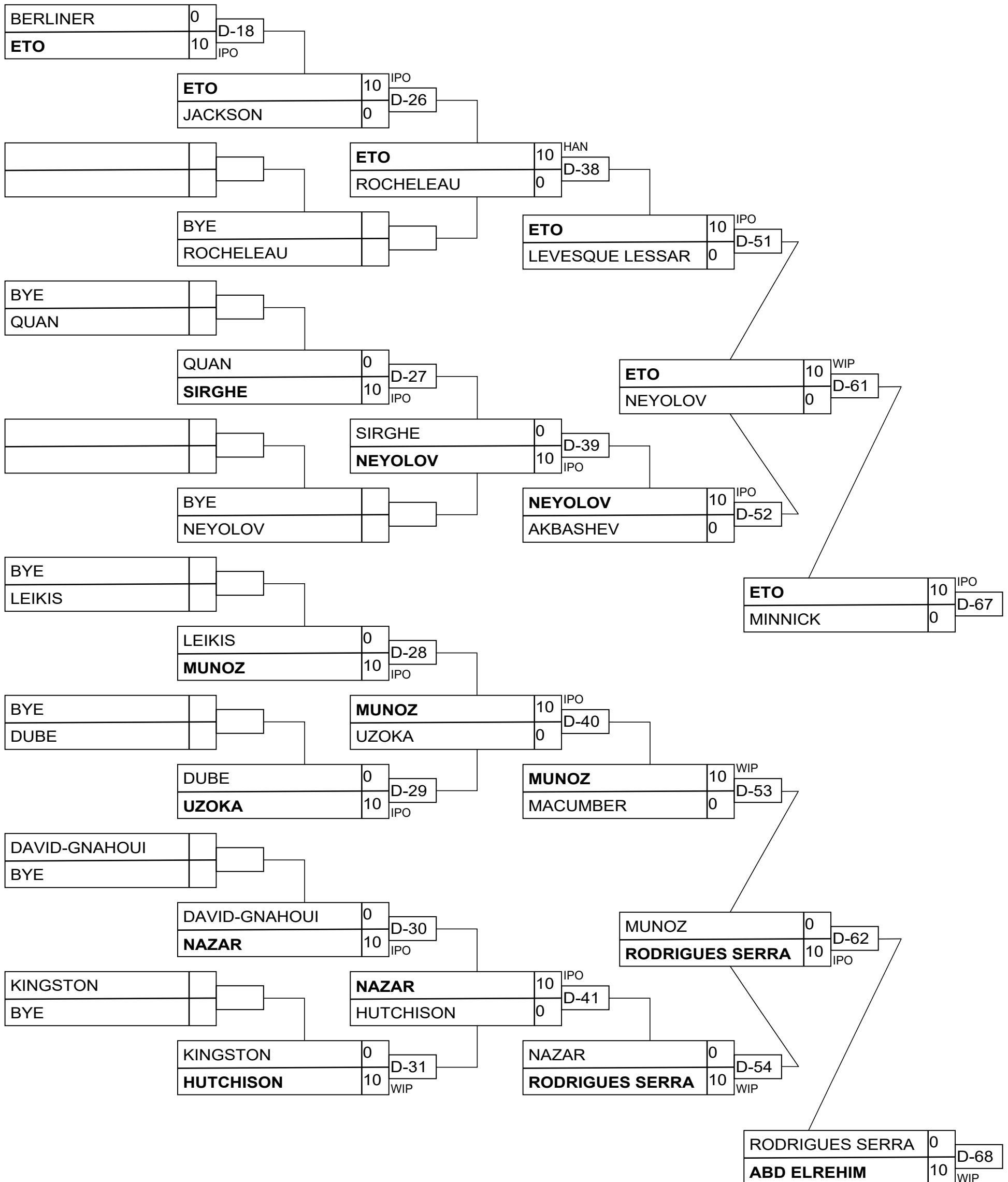

Senior Advanced Men +100kg

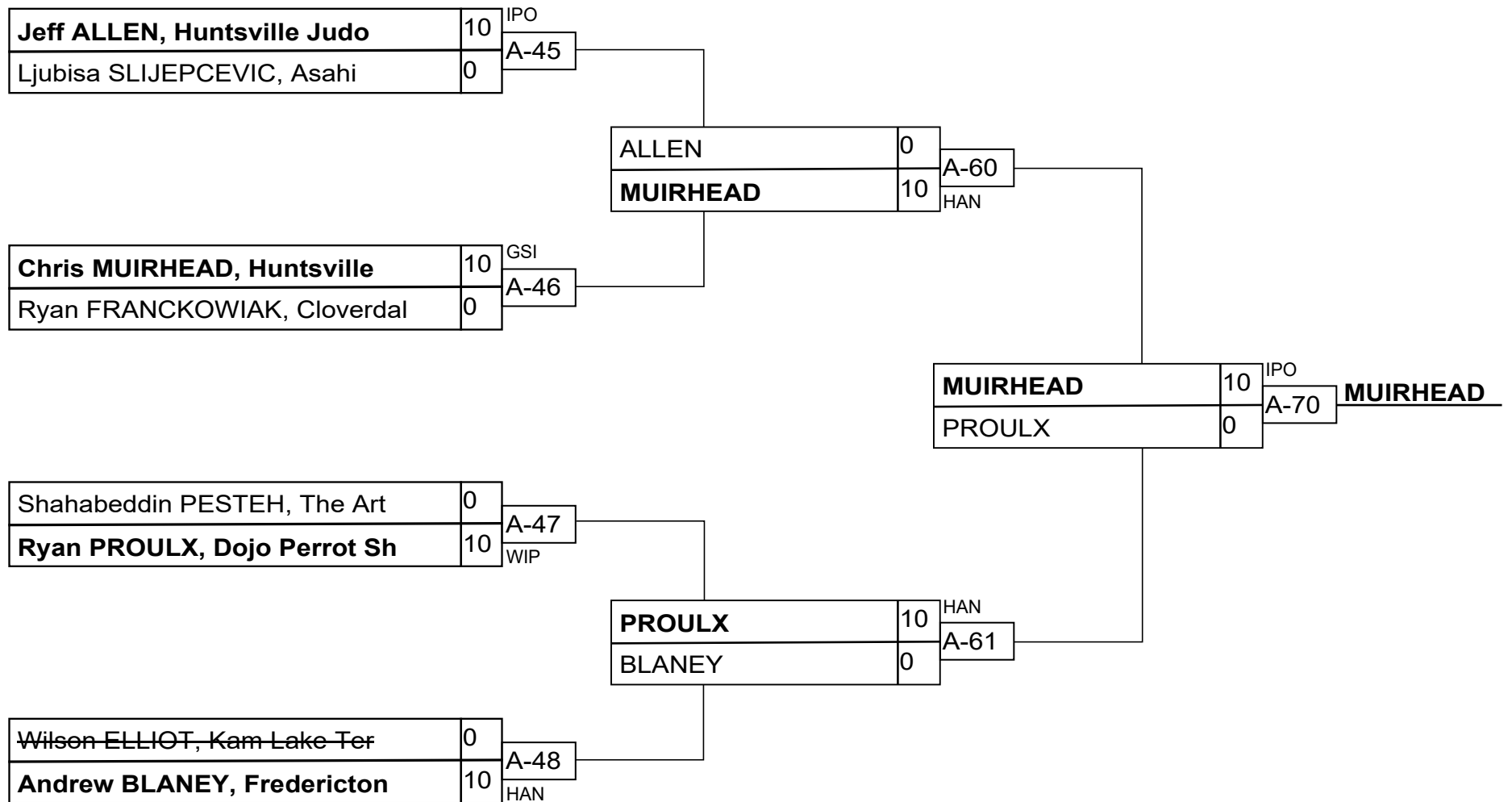

Results/Résultats

Pos	Name/Nom
1	Chris MUIRHEAD, Huntsvil
2	Ryan PROULX, Dojo Perrot
3	Jeff ALLEN, Huntsville J
3	Ljubisa SLIJEPCEVIC, Asa

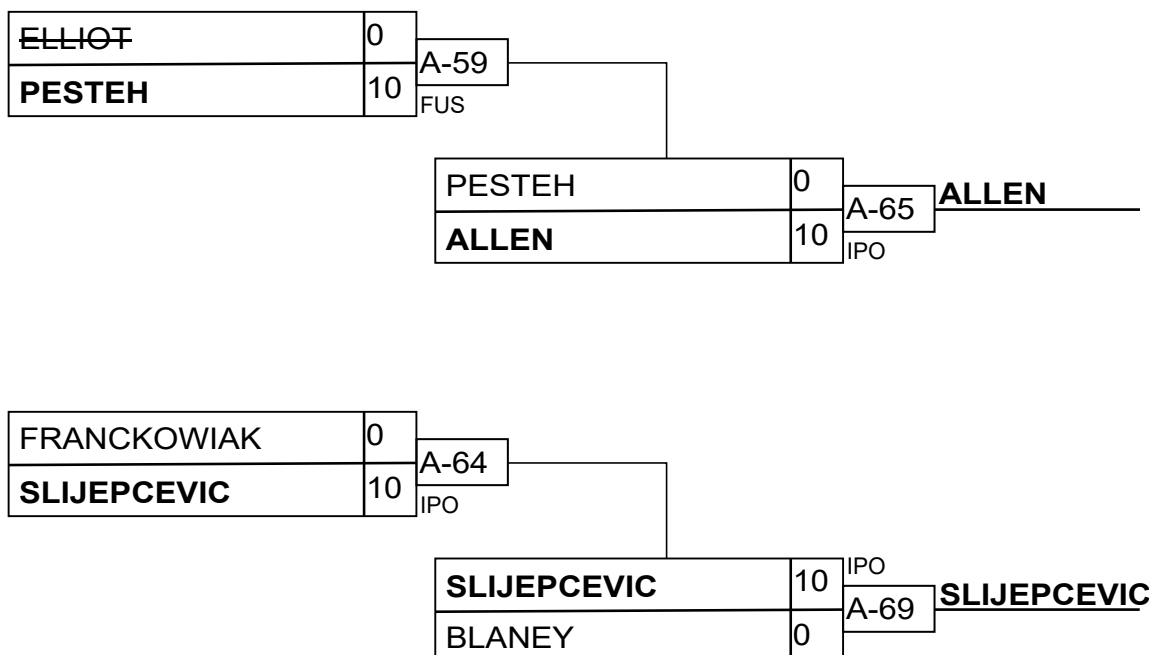

Senior Nov Women Light

Competitors/Compétiteurs

#	Name/Nom	Grade	Club	1	W/G	Pts	Pos
1	Kathleen GORMANSHAW	Green	Asahi Judo Club	XX	0	0	1

Matches/Matches

Match	White/Blanc	Blue/Bleu	Res/Rés	Tim/Tmp	Code
-------	-------------	-----------	---------	---------	------

Results/Résultats

Pos	Name/Nom

Senior Novice Men Heavy

Competitors/Compétiteurs

#	Name/Nom	Grade	Club	1	W/G	Pts	Pos
1	Jeffrey BARTER	Green	Formokan Judo Club	XX	0	0	1

Matches/Matches

Match	White/Blanc	Blue/Bleu	Res/Rés	Tim/Tmp	Code
-------	-------------	-----------	---------	---------	------

Results/Résultats

Pos	Name/Nom

Senior Novice Men Light

Competitors/Compétiteurs

#	Name/Nom	Grade	Club	1	2	3	4	5	W/G	Pts	Pos
1	Aidan KEYES	Blue	Police Judo Junior	XX	10	10	10	10	4	40	1
2	Johnathan XINKAS	Blue	Taifu Judo Club		XX				0	0	5
3	Marco ARAB	Blue	Jccc - Judo Kai		10	XX	10	10	3	30	2
4	Aydin GREENWOOD	Blue	Hart Judo Academy		10		XX	10	2	20	3
5	Jacob LOWE	Blue	Victoria Judo Club		1			XX	1	1	4

Matches/Matches

Match	White/Blanc			Blue/Bleu	Res/Rés	Tim/Tmp	Code
A-14	Aydin GREENWOOD	4	5	Jacob LOWE	10 - 0	0:48	IPO
A-17	Aidan KEYES	1	2	Johnathan XINKAS	10 - 0	0:00	KIK
A-26	Marco ARAB	3	4	Aydin GREENWOOD	10 - 0	0:57	IPO
A-27	Aidan KEYES	1	5	Jacob LOWE	10 - 0	2:25	IPO
A-31	Johnathan XINKAS	2	3	Marco ARAB	0 - 10	0:00	KIK
A-32	Aidan KEYES	1	4	Aydin GREENWOOD	10 - 0	0:39	IPO
A-39	Marco ARAB	3	5	Jacob LOWE	10 - 0	0:00	KIK
A-40	Johnathan XINKAS	2	4	Aydin GREENWOOD	0 - 10	0:00	KIK
A-45	Aidan KEYES	1	3	Marco ARAB	10 - 0	1:55	IPO
10	Johnathan XINKAS	2	5	Jacob LOWE	0 - 1	0:00	YUS

Results/Résultats

Pos	Name/Nom
1	Aidan KEYES, Police Judo Junior
2	Marco ARAB, Jccc - Judo Kai
3	Aydin GREENWOOD, Hart Judo Academy
4	Jacob LOWE, Victoria Judo Club

Senior Novice Men Light Heavy

Competitors/Compétiteurs

#	Name/Nom	Grade	Club	1	2	3	4	5	W/G	Pts	Pos
1	Glen CROLEY	Blue	Budo Judo Club	XX		10	10		2	20	4
2	Salvador ASSAR	Green	Action and Reaction MMA	10	XX	10			2	20	3
3	Ovidiu PODARIU	Green	Full Circle Judo Club			XX			0	0	5
4	Robert HOLTBY	Blue	Cloverdale Judo Club		5	10	XX	10	3	25	2
5	Samuel BILODEAU	Blue	Cloverdale Judo Club	10	10	10		XX	3	30	1

Matches/Matches

Match	White/Blanc			Blue/Bleu	Res/Rés	Tim/Tmp	Code
E-19	Robert HOLTBY	4	5	Samuel BILODEAU	10 - 0	1:40	IPO
E-20	Glen CROLEY	1	2	Salvador ASSAR	0 - 10	1:07	IPO
E-24	Ovidiu PODARIU	3	4	Robert HOLTBY	0 - 10	3:25	WIP
E-25	Glen CROLEY	1	5	Samuel BILODEAU	0 - 10	0:10	IPO
E-31	Salvador ASSAR	2	3	Ovidiu PODARIU	10 - 0	0:27	IPO
E-32	Glen CROLEY	1	4	Robert HOLTBY	10 - 0	0:11	IPO
E-43	Ovidiu PODARIU	3	5	Samuel BILODEAU	0 - 10	1:29	IPO
E-44	Salvador ASSAR	2	4	Robert HOLTBY	0 - 5	4:00	WAZ
E-51	Glen CROLEY	1	3	Ovidiu PODARIU	10 - 0	0:43	IPO
E-52	Salvador ASSAR	2	5	Samuel BILODEAU	0 - 10	1:40	IPO

Results/Résultats

Pos	Name/Nom
1	Samuel BILODEAU, Cloverdale Judo Club
2	Robert HOLTBY, Cloverdale Judo Club
3	Salvador ASSAR, Action and Reaction MMA
4	Glen CROLEY, Budo Judo Club

Senior Novice Men Middle

Competitors/Compétiteurs A

#	Name/Nom	Grade	Club	1	2	3	4	W/G	Pts	Pos
1	Noah BARKHOUSE	Blue	Cloverdale Judo Club	XX	10	10	10	3	30	1
2	Philipp DOHM	Blue	Cloverdale Judo Club		XX			0	0	4
3	Braeden ARBOUR	Green	Trent Judo Club		10	XX		1	10	3
4	Trevor Yi WONG	Blue	Action and Reaction MMA		10	10	XX	2	20	2

Pool A

Match	White/Blanc	Blue/Bleu	Res/Rés	Tim/Tmp	Code
B-25	Noah BARKHOUSE 1 2	Philipp DOHM	10 - 0	1:16	WIP
B-26	Braeden ARBOUR 3 4	Trevor Yi WONG	0 - 10	4:22	GSI
B-34	Noah BARKHOUSE 1 3	Braeden ARBOUR	10 - 0	1:37	IPO
B-35	Philipp DOHM 2 4	Trevor Yi WONG	0 - 10	1:36	IPO
B-42	Noah BARKHOUSE 1 4	Trevor Yi WONG	10 - 0	1:28	IPO
B-43	Philipp DOHM 2 3	Braeden ARBOUR	0 - 10	0:52	WIP

Competitors/Compétiteurs B

#	Name/Nom	Grade	Club	5	6	7	W/G	Pts	Pos
5	Everett WATSON	Blue	Cloverdale Judo Club	XX	10	10	2	20	1
6	Wilfred CUEVAS	Green	Action and Reaction MMA		XX	10	1	10	2
7	Patrick BROPHY	Green	York Judo & BJJ			XX	0	0	3

Pool B

Match	White/Blanc	Blue/Bleu	Res/Rés	Tim/Tmp	Code
B-27	Everett WATSON 5 6	Wilfred CUEVAS	10 - 0	1:43	IPO
B-36	Everett WATSON 5 7	Patrick BROPHY	10 - 0	3:11	IPO
B-44	Wilfred CUEVAS 6 7	Patrick BROPHY	10 - 0	5:28	HAN

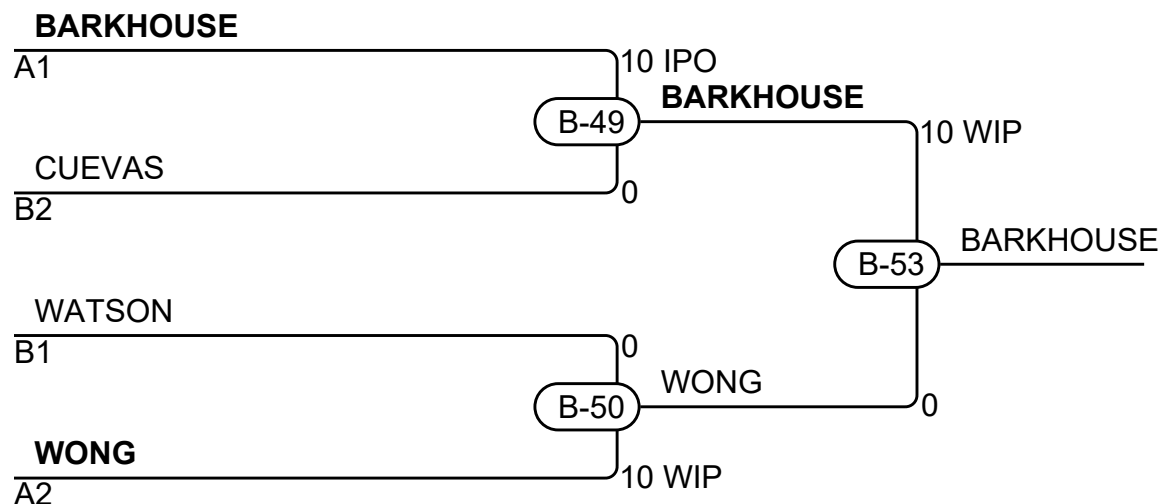

Results/Résultats

Pos	Name/Nom
1	Noah BARKHOUSE, Cloverdale Judo Club
2	Trevor Yi WONG, Action and Reaction MMA
3	Wilfred CUEVAS, Action and Reaction MMA
3	Everett WATSON, Cloverdale Judo Club

Competitors/Compétiteurs A

#	Name/Nom	Grade	Club	1	2	3	W/G	Pts	Pos
1	Éliandre BARRIAULT-TREMBLA	Blue	Club judokas Jonquière i	XX		10	1	10	1
2	Hugo LEVACHER	Brown	Club de judo Torakai	5	XX		1	5	3
3	Hugo BROWN	Blue	Hiro's Judo Club		5	XX	1	5	2

Pool A

Match	White/Blanc	Blue/Bleu	Res/Rés	Tim/Tmp	Code
C-26	Éliandre BARRIAULT-TREMBLAY 1 2	Hugo LEVACHER	0 - 5	3:00	WAZ
C-37	Éliandre BARRIAULT-TREMBLAY 1 3	Hugo BROWN	10 - 0	1:44	WIP
C-43	Hugo LEVACHER 2 3	Hugo BROWN	0 - 5	3:00	WAZ

Competitors/Compétiteurs B

#	Name/Nom	Grade	Club	4	5	6	W/G	Pts	Pos
4	Linus FRIZELL	Green	Hart Judo Academy	XX		10	1	10	2
5	Vincent NEPTON	Blue	Club judokas Jonquière i	10	XX	10	2	20	1
6	Wyatt MARKALL	Green	Thunder Bay Judo Dojo			XX	0	0	3

Pool B

Match	White/Blanc	Blue/Bleu	Res/Rés	Tim/Tmp	Code
C-27	Linus FRIZELL 4 5	Vincent NEPTON	0 - 10	0:26	IPO
C-38	Linus FRIZELL 4 6	Wyatt MARKALL	10 - 0	0:12	IPO
C-44	Vincent NEPTON 5 6	Wyatt MARKALL	10 - 0	0:05	IPO

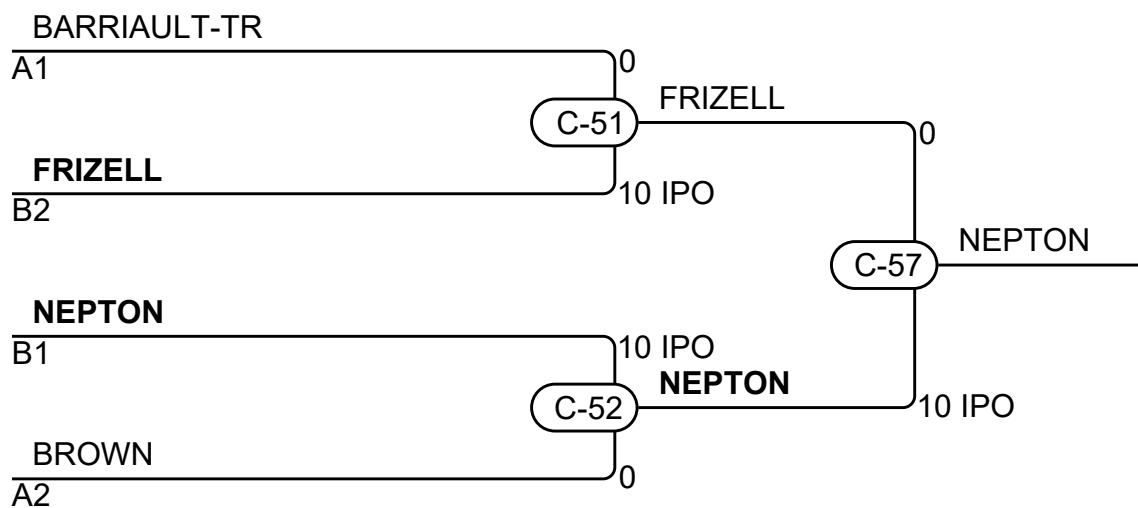

Results/Résultats

Pos	Name/Nom
1	Vincent NEPTON, Club judokas Jonquière inc.
2	Linus FRIZELL, Hart Judo Academy
3	Éliandre BARRIAULT-TREMBLAY, Club judokas Jon
3	Hugo BROWN, Hiro's Judo Club

U16 Men -42kg

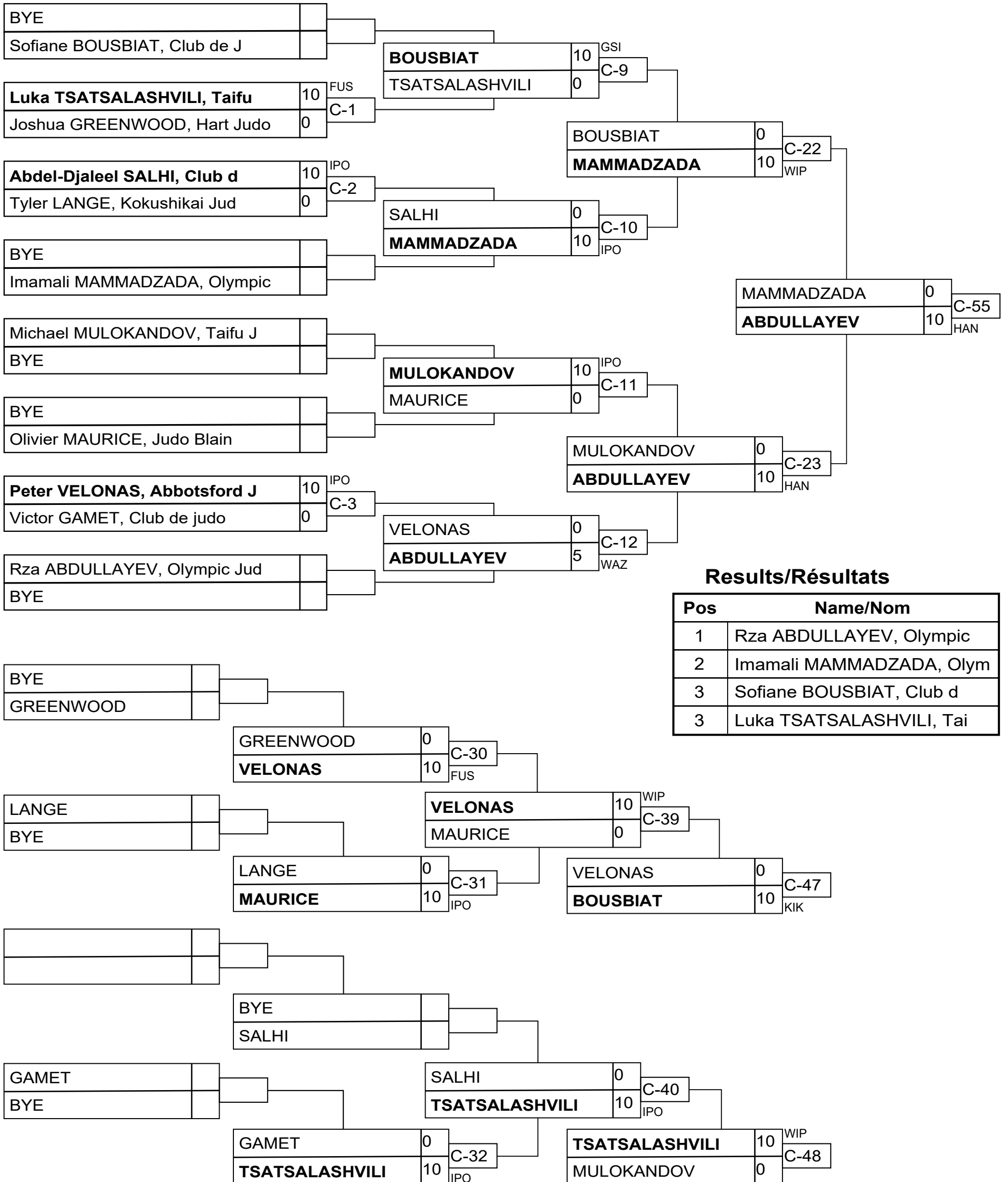

U16 Men -46kg

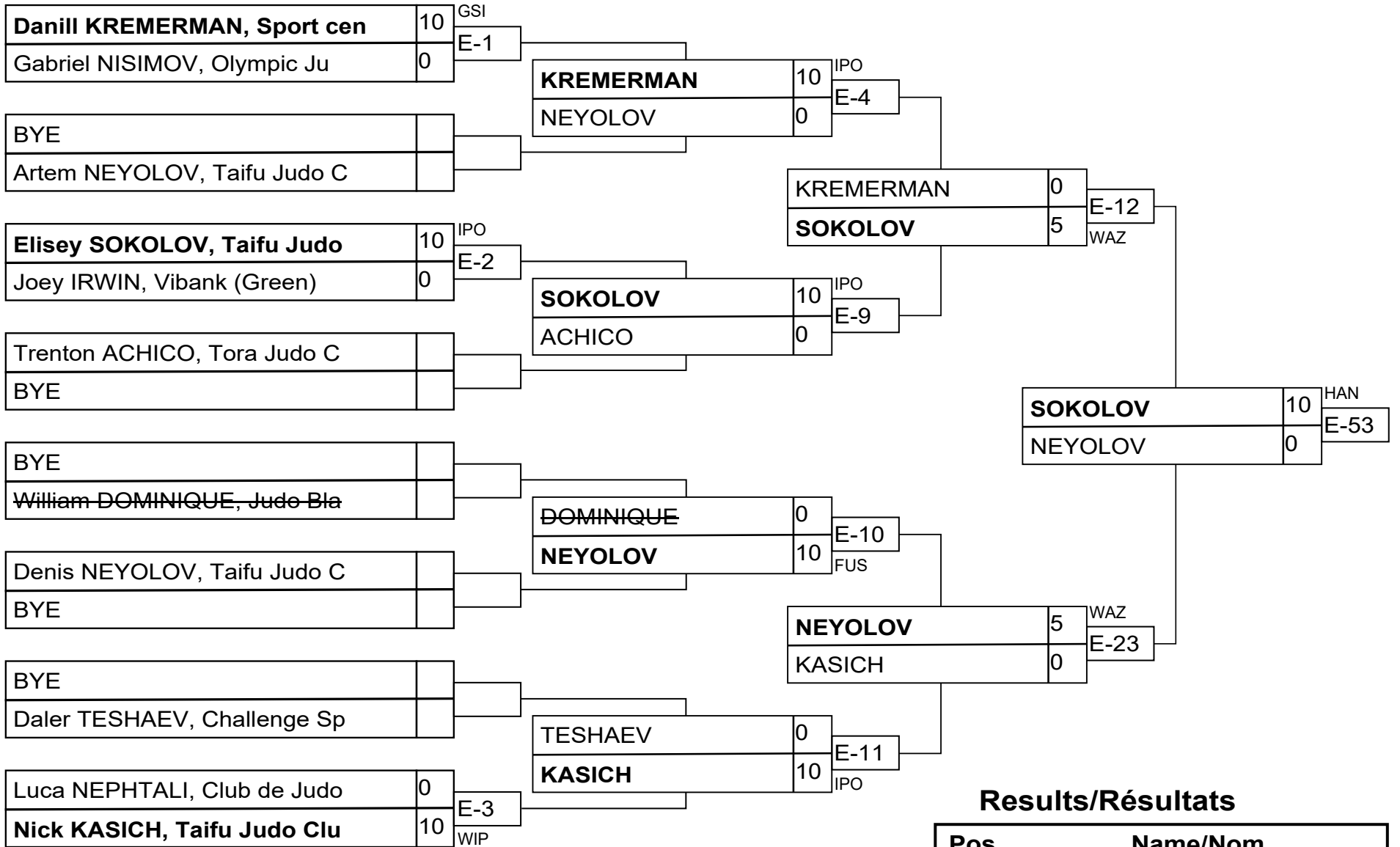

Results/Résultats

Pos	Name/Nom
1	Elisey SOKOLOV, Taifu Ju
2	Denis NEYOLOV, Taifu Jud
3	Danill KREMERMANN, Sport
3	Nick KASICH, Taifu Judo

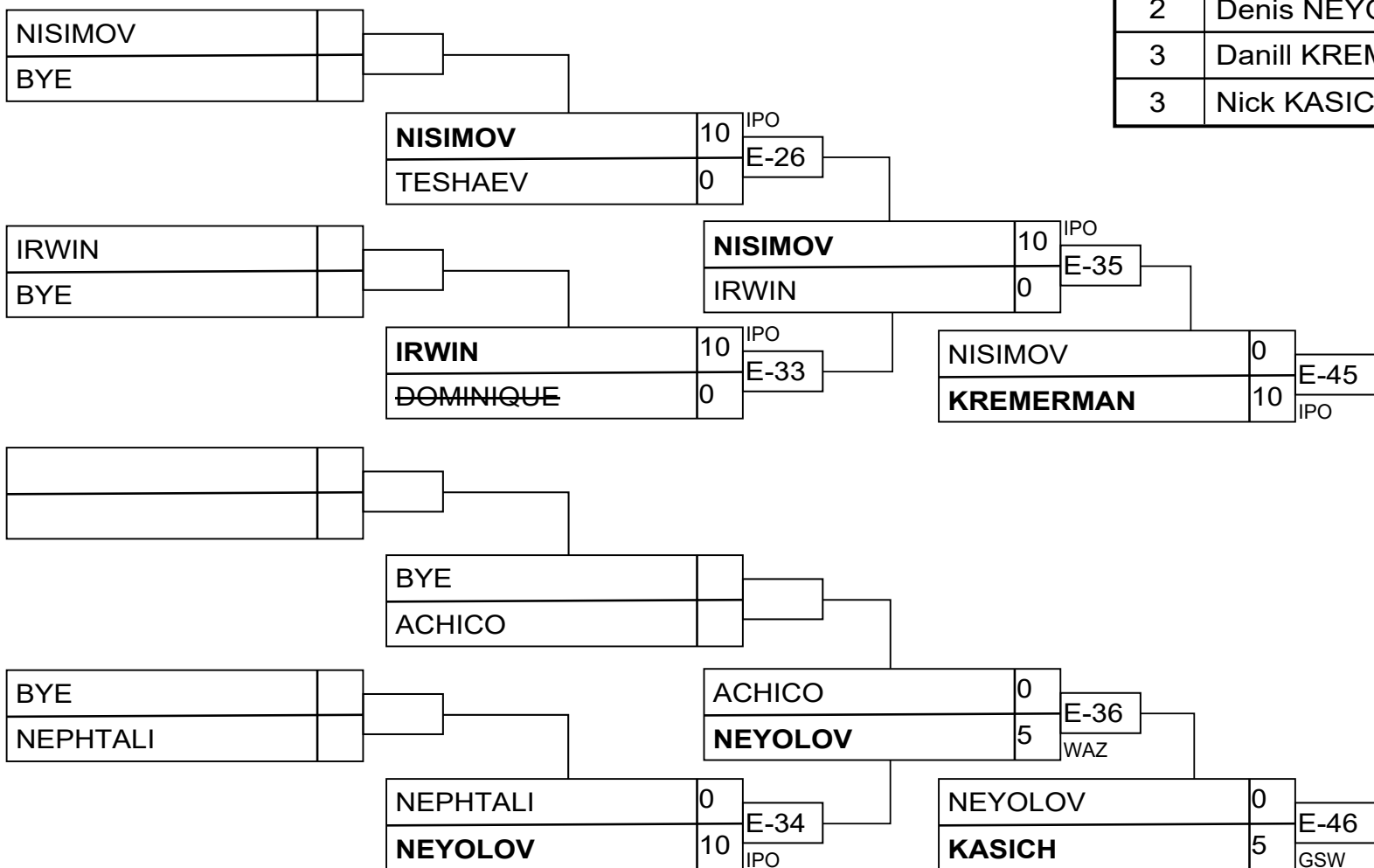

U16 Men -50kg

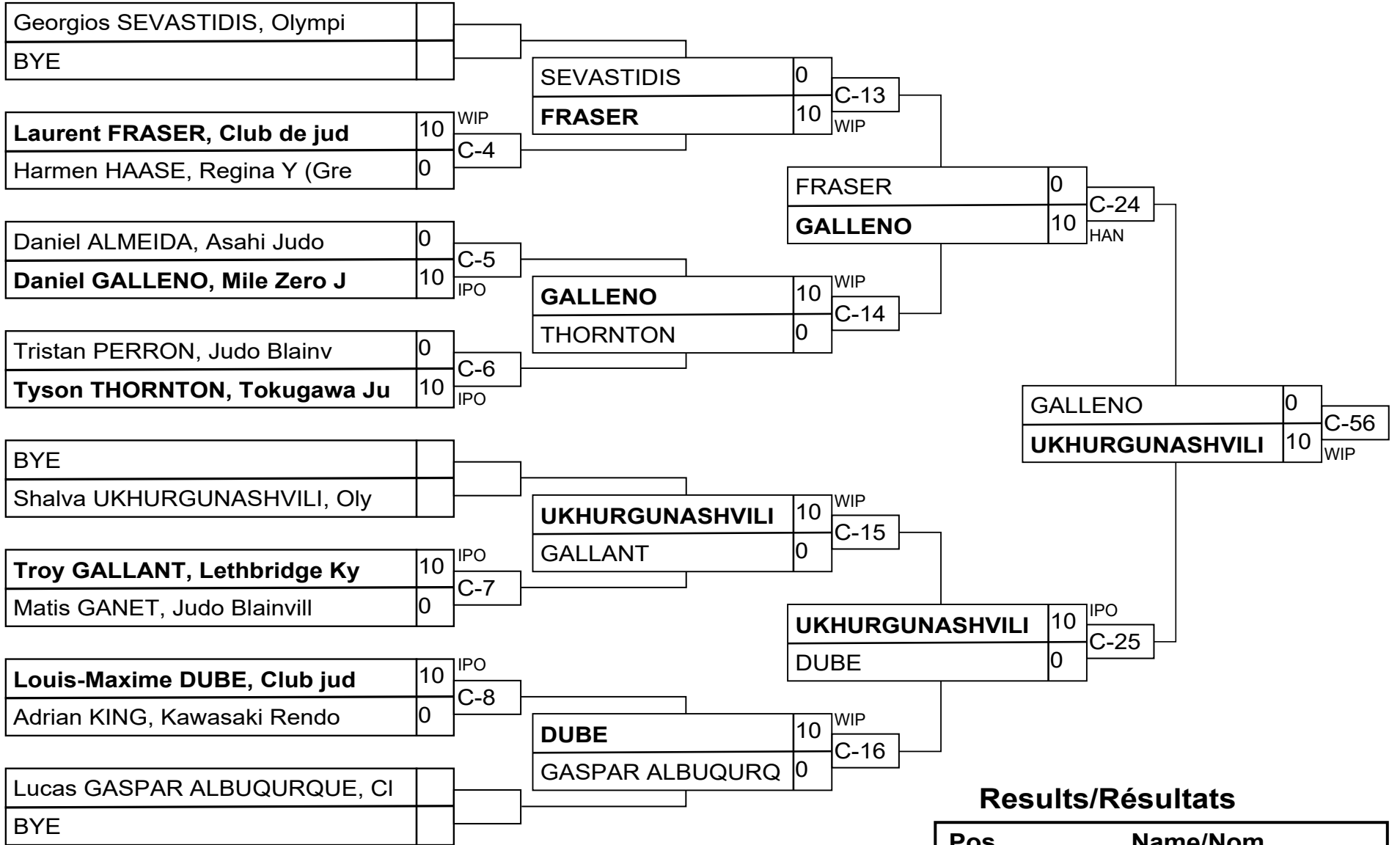

Results/Résultats

Pos	Name/Nom
1	Shalva UKHURGUNASHVILI,
2	Daniel GALLENO, Mile Zer
3	Troy GALLANT, Lethbridge
3	Louis-Maxime DUBE, Club

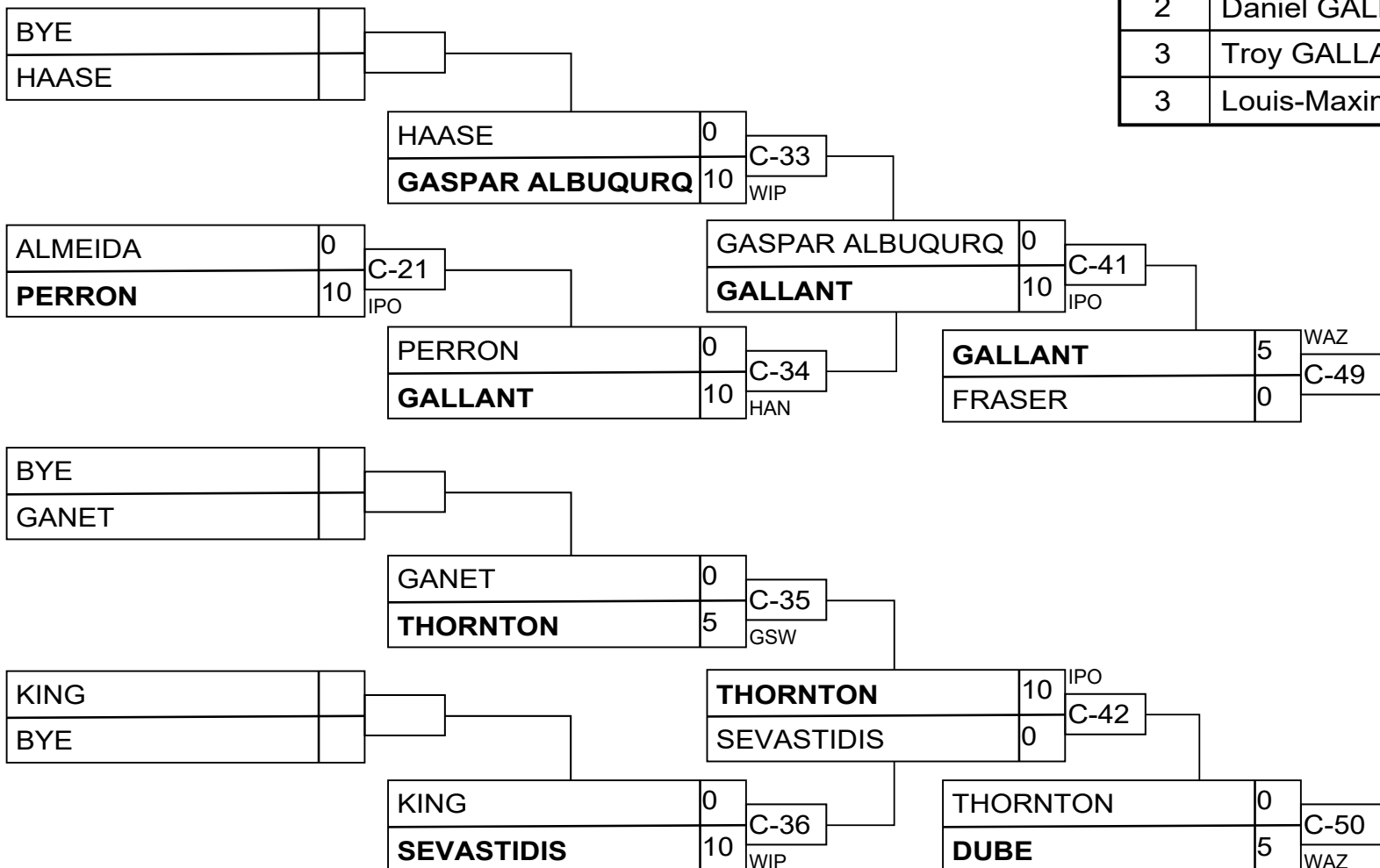

U16 Men -55kg

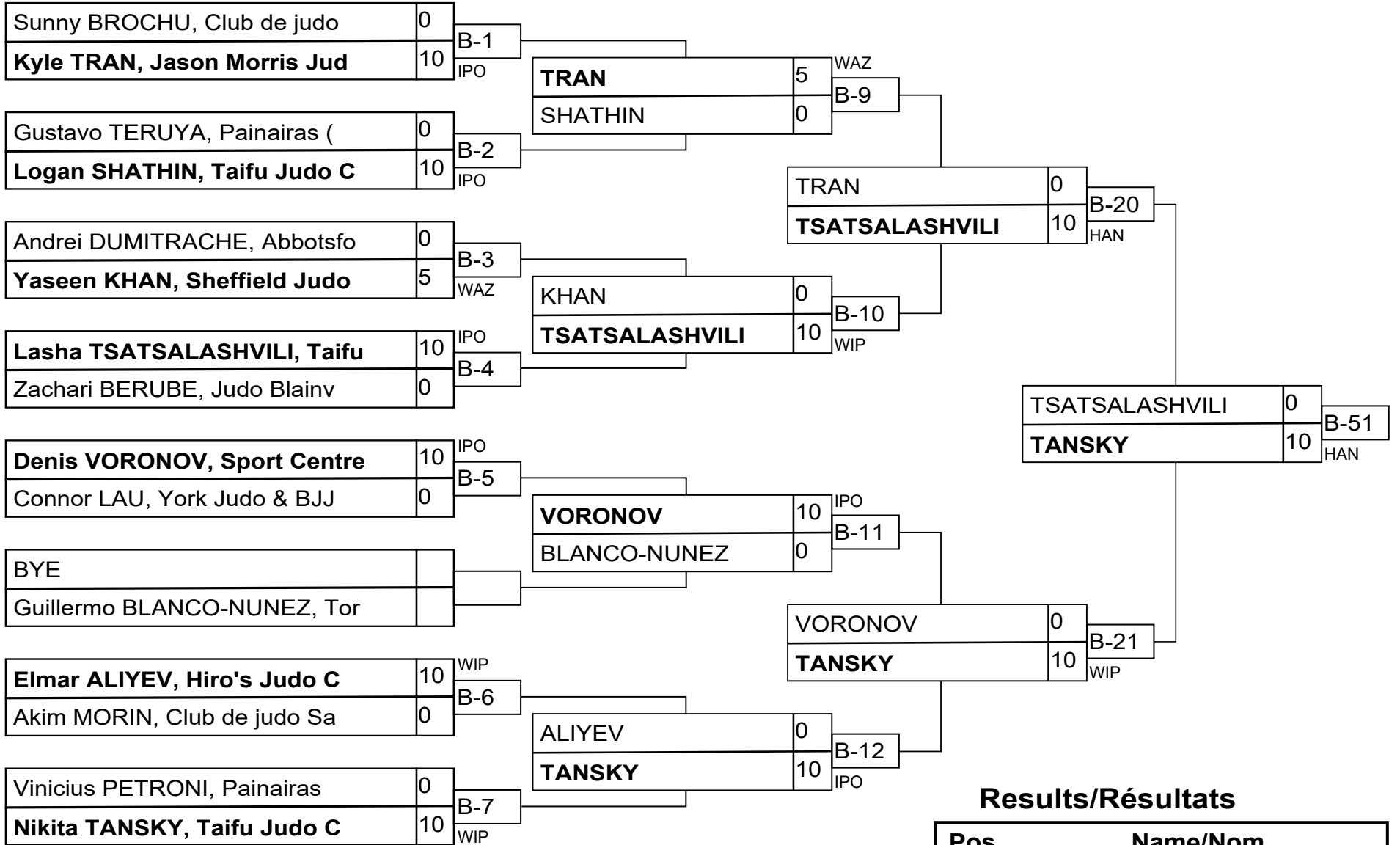

Results/Résultats

Pos	Name/Nom
1	Nikita TANSKY, Taifu Jud
2	Lasha TSATSALASHVILI, Ta
3	Kyle TRAN, Jason Morris
3	Denis VORONOV, Sport Cen

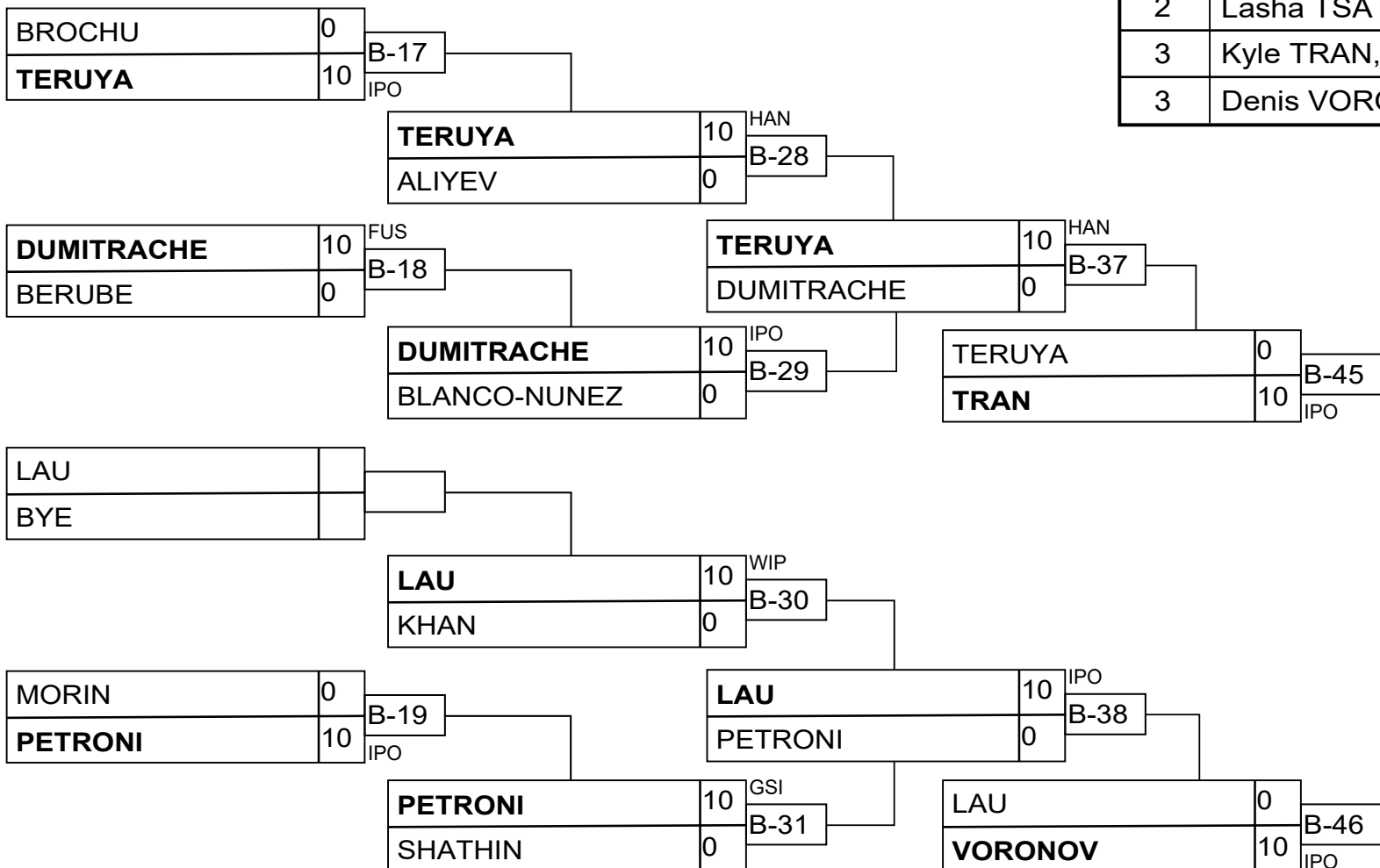

U16 Men -60kg

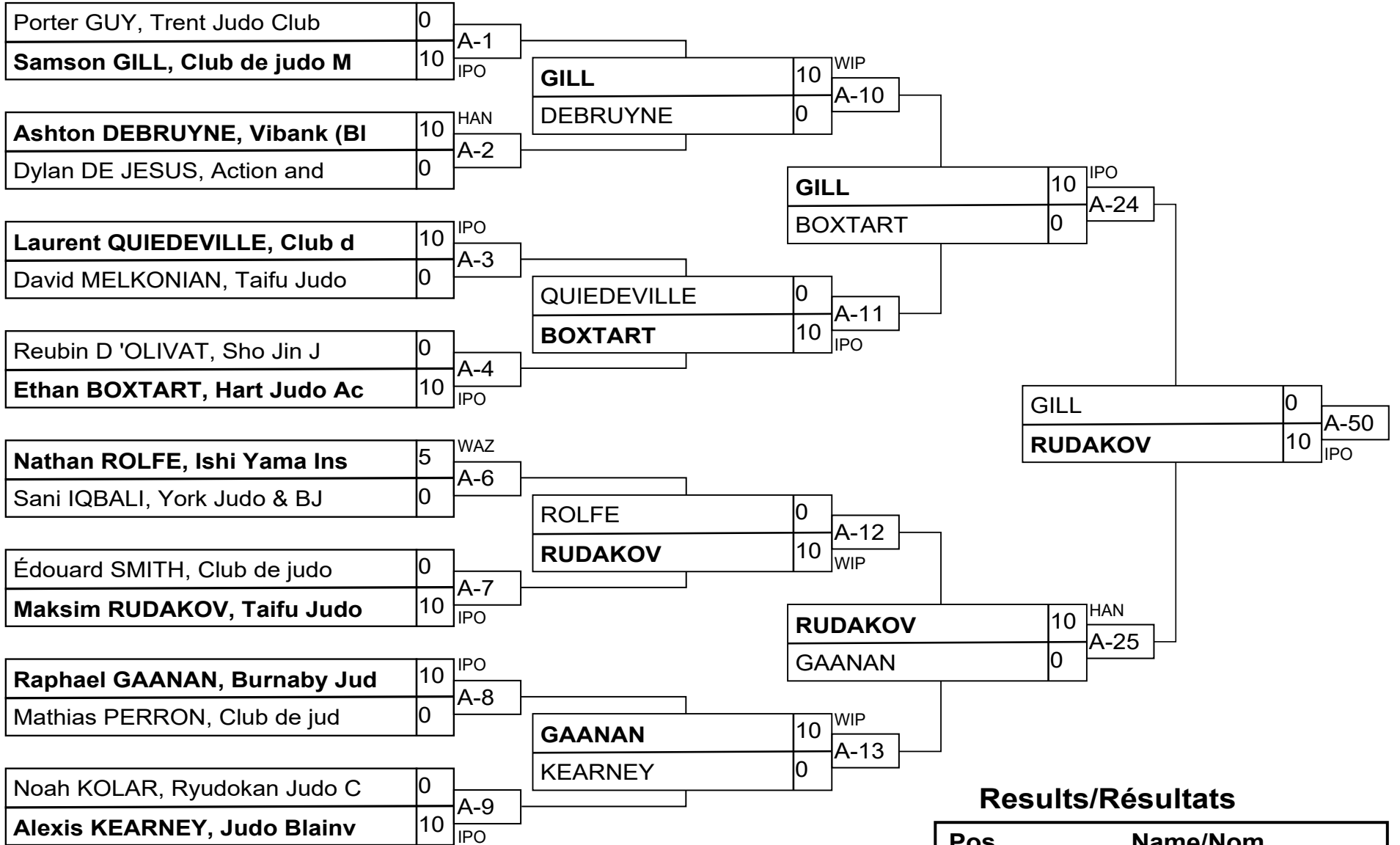

Results/Résultats

Pos	Name/Nom
1	Maksim RUDAKOV, Taifu Ju
2	Samson GILL, Club de jud
3	Alexis KEARNEY, Judo Bla
3	Raphael GAANAN, Burnaby

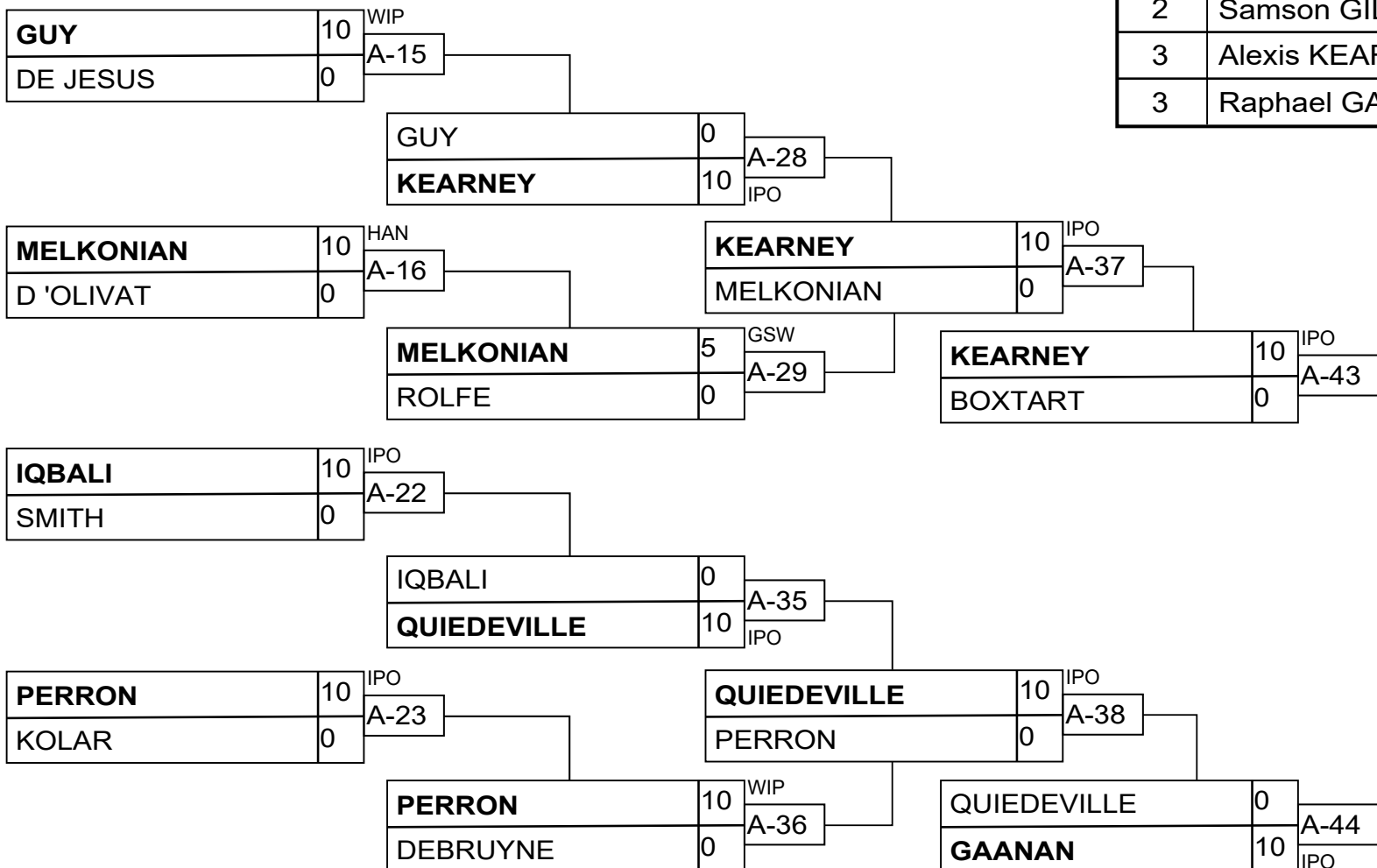

U16 Men -66kg

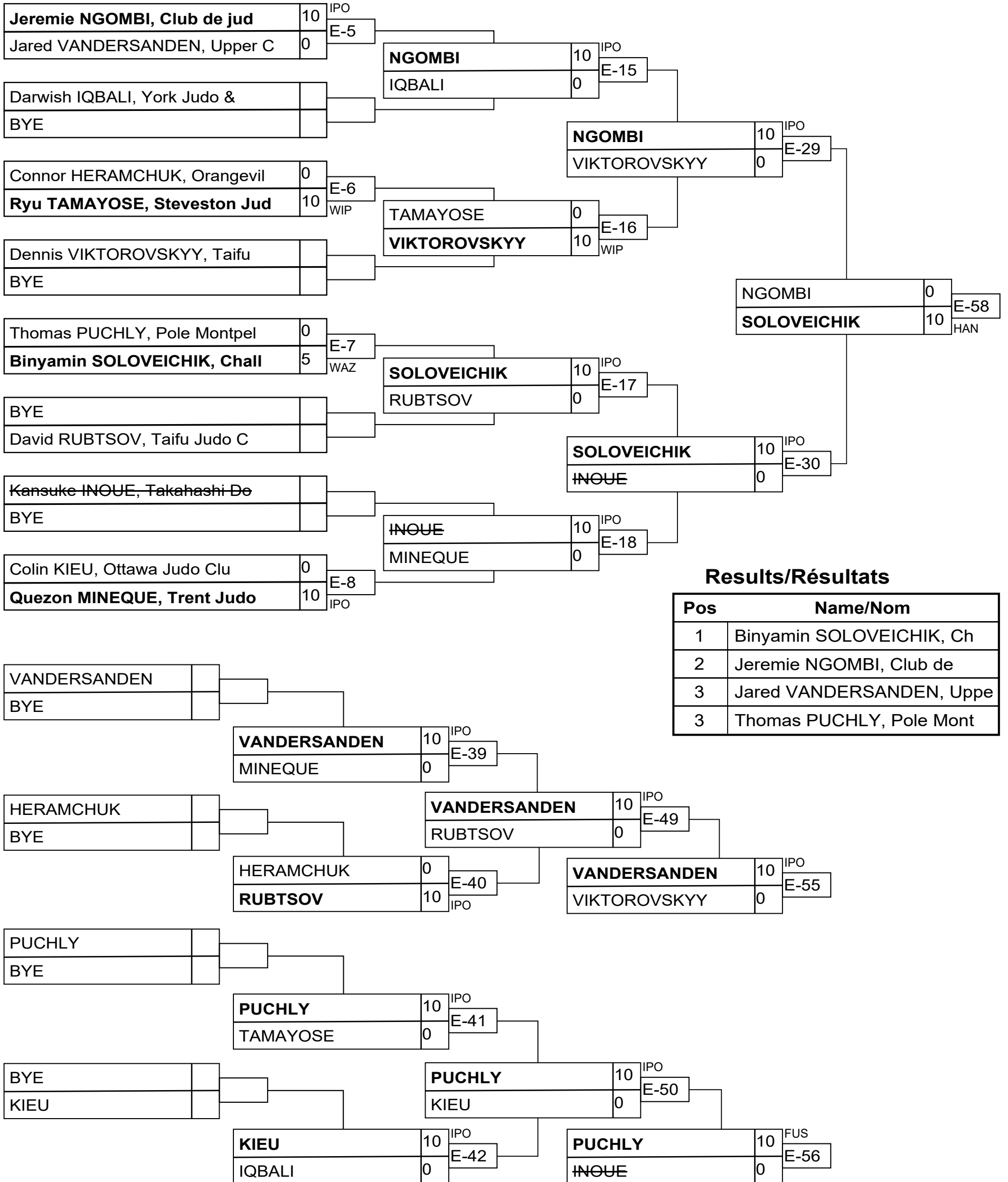

U16 Men -73kg

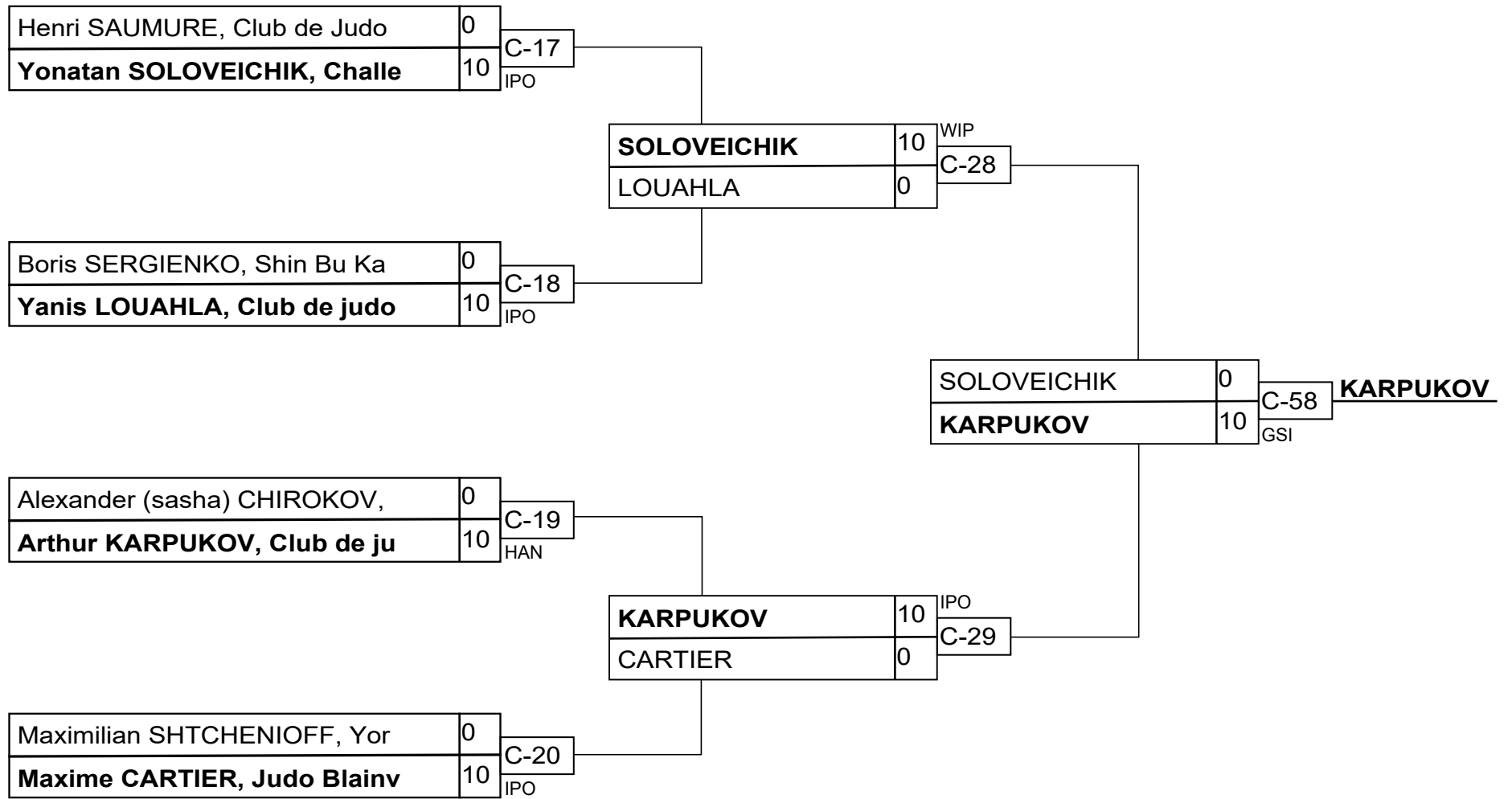

Results/Résultats

Pos	Name/Nom
1	Arthur KARPUKOV, Club de
2	Yonatan SOLOVEICHIK, Cha
3	Alexander (sasha) CHIROK
3	Maxime CARTIER, Judo Bla

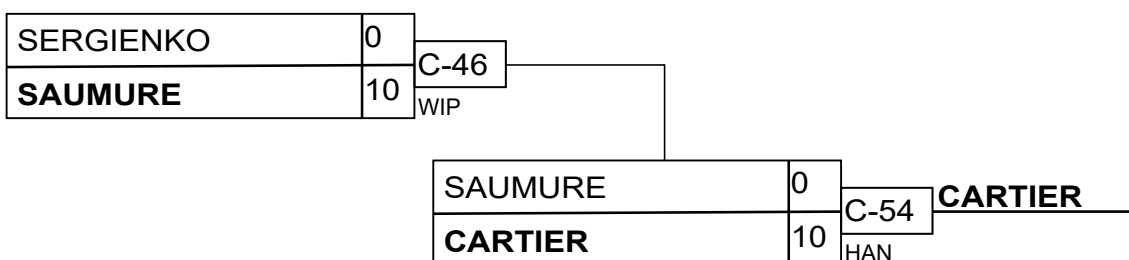
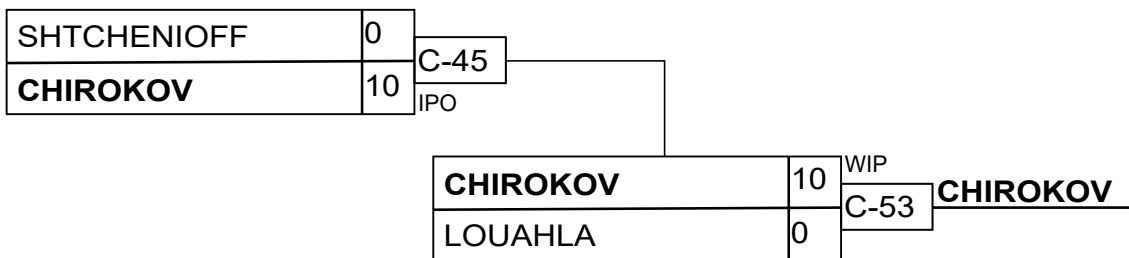

U16 Men +73kg

Competitors/Compétiteurs

#	Name/Nom	Grade	Club	1	2	3	4	5	W/G	Pts	Pos
1	Matthew SERRANO	Blue	AJAX Budokan	XX	10		10	10	3	30	2
2	Josiah HALLETT	Green	La Ronge Judo Club		XX		10	10	2	20	3
3	John Jr MESSÉ A BESSONG	Blue	Club de judo Shidokan in	10	10	XX	10	10	4	40	1
4	Cooper MCLEOD	Green	Kam Lake Territorial Cen				XX		0	0	5
5	Norman BRAZHNYK	Green	Challenge Sports Club				10	XX	1	10	4

Matches/Matches

Match	White/Blanc			Blue/Bleu	Res/Rés	Tim/Tmp	Code
E-13	Cooper MCLEOD	4	5	Norman BRAZHNYK	0 - 10	1:53	WIP
E-14	Matthew SERRANO	1	2	Josiah HALLETT	10 - 0	6:05	HAN
E-21	John Jr MESSÉ A BESSONG	3	4	Cooper MCLEOD	10 - 0	0:13	IPO
E-22	Matthew SERRANO	1	5	Norman BRAZHNYK	10 - 0	0:09	IPO
E-27	Josiah HALLETT	2	3	John Jr MESSÉ A BESSONG	0 - 10	1:28	WIP
E-28	Matthew SERRANO	1	4	Cooper MCLEOD	10 - 0	0:29	IPO
E-37	John Jr MESSÉ A BESSONG	3	5	Norman BRAZHNYK	10 - 0	0:14	IPO
E-38	Josiah HALLETT	2	4	Cooper MCLEOD	10 - 0	0:59	IPO
E-47	Matthew SERRANO	1	3	John Jr MESSÉ A BESSONG	0 - 10	2:11	WIP
E-48	Josiah HALLETT	2	5	Norman BRAZHNYK	10 - 0	0:13	IPO

Results/Résultats

Pos	Name/Nom
1	John Jr MESSÉ A BESSONG, Club de judo Shidoka
2	Matthew SERRANO, AJAX Budokan
3	Josiah HALLETT, La Ronge Judo Club
4	Norman BRAZHNYK, Challenge Sports Club

U16 Women -40kg

Competitors/Compétiteurs

#	Name/Nom	Grade	Club	1	2	1	2	1	2	W/G	Pts	Pos
1	Teya MAIHARA	Green	Police Judo Junior	XX	10	XX		XX	5	2	15	1
2	Sasha WELDON	Green	Formokan Judo Club		XX	5	XX		XX	1	5	2

Matches/Matches

Match	White/Blanc			Blue/Bleu	Res/Rés	Tim/Tmp	Code
A-34	Teya MAIHARA	1	2	Sasha WELDON	10 - 0	2:59	WIP
A-42	Sasha WELDON	2	1	Teya MAIHARA	5 - 0	5:13	GSW
A-49	Teya MAIHARA	1	2	Sasha WELDON	5 - 0	4:56	GSW

Results/Résultats

Pos	Name/Nom
1	Teya MAIHARA, Police Judo Junior
2	Sasha WELDON, Formokan Judo Club

U16 Women -44kg

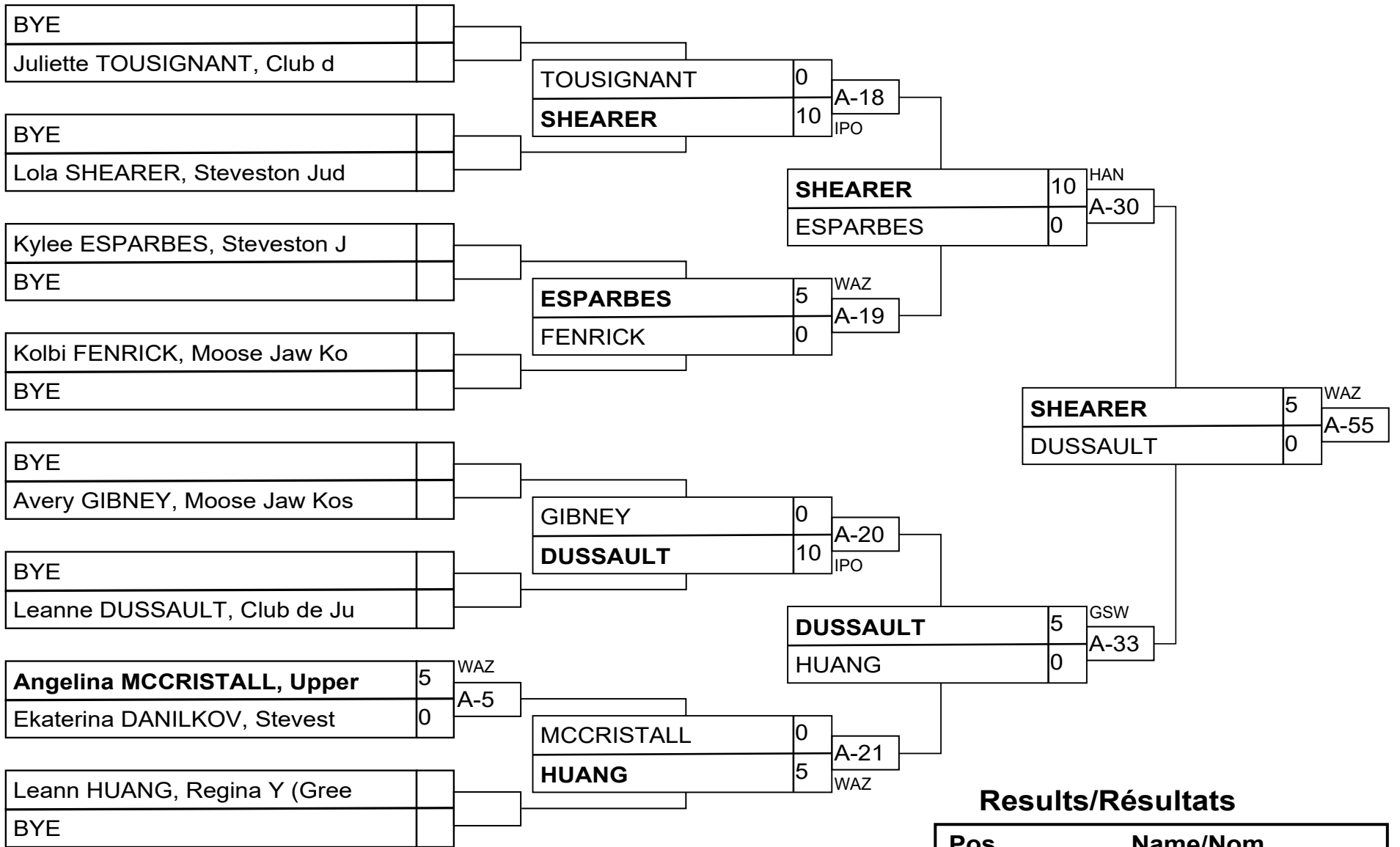

Results/Résultats

Pos	Name/Nom
1	Lola SHEARER, Steveston
2	Leanne DUSSAULT, Club de
3	Angelina MCCRISTALL, Upp
3	Ekaterina DANILKOV, Stev

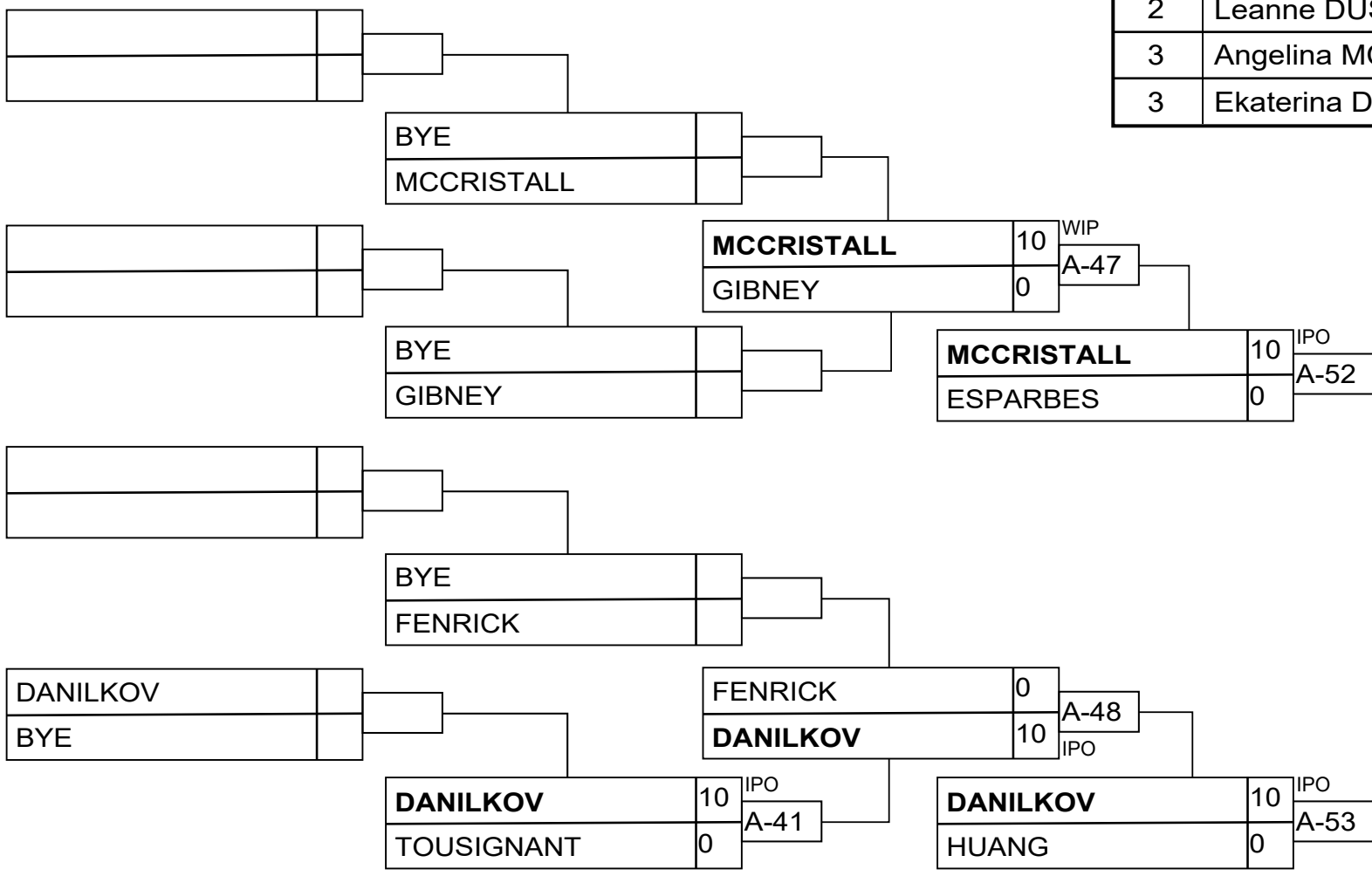

U16 Women -48kg

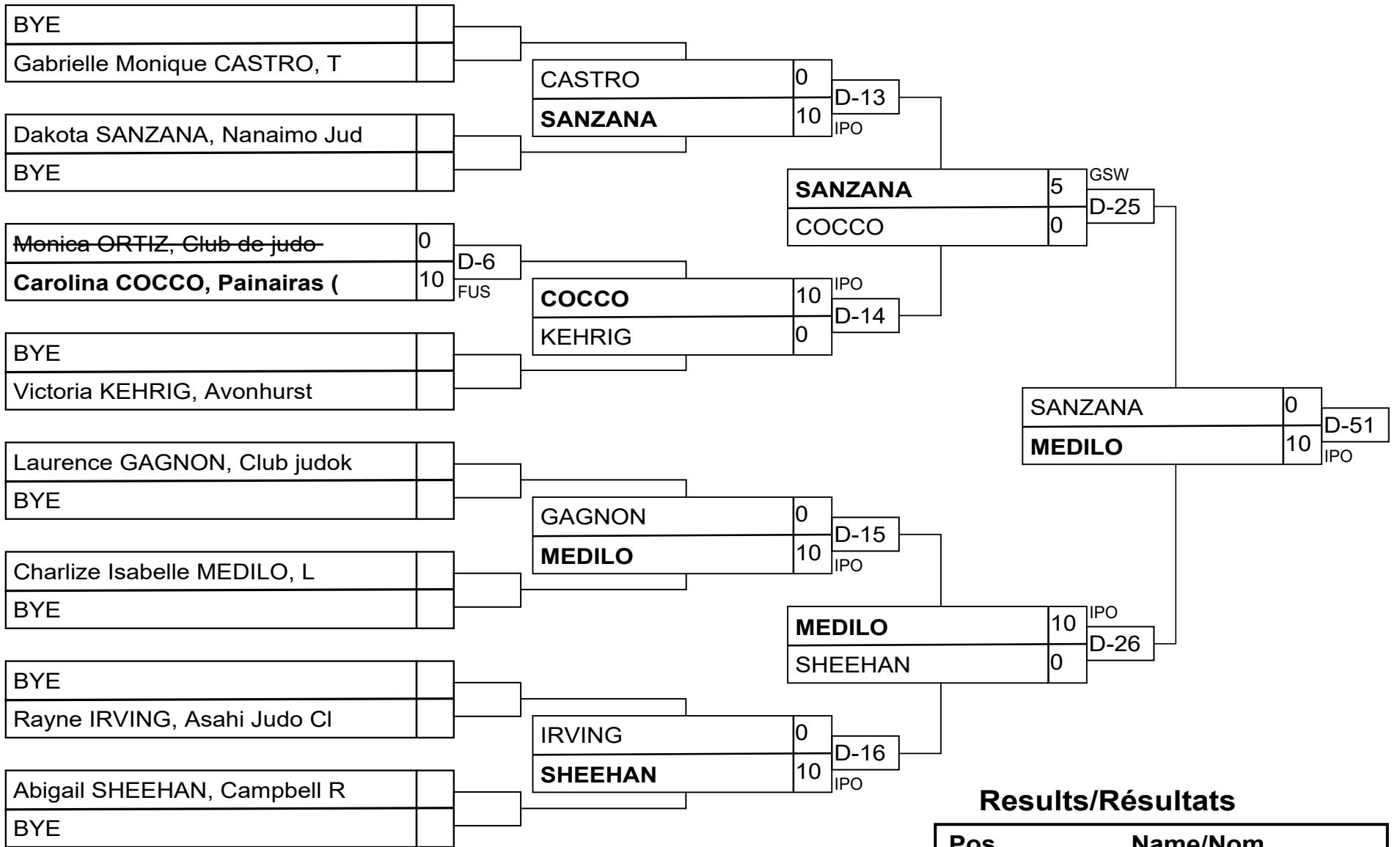

Results/Résultats

Pos	Name/Nom
1	Charlize Isabelle MEDILO
2	Dakota SANZANA, Nanaimo
3	Laurence GAGNON, Club ju
3	Abigail SHEEHAN, Campbel

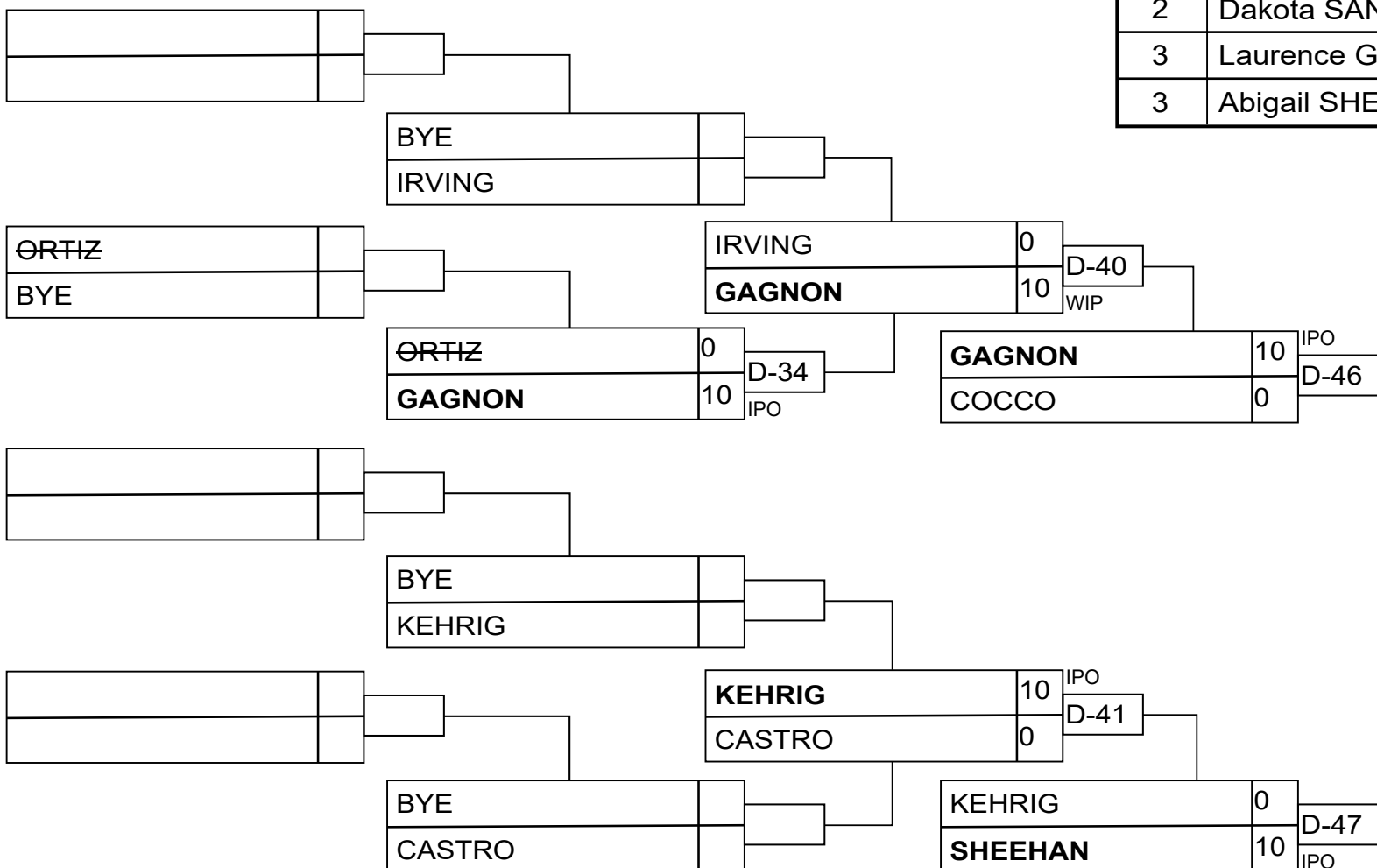

U16 Women -52kg

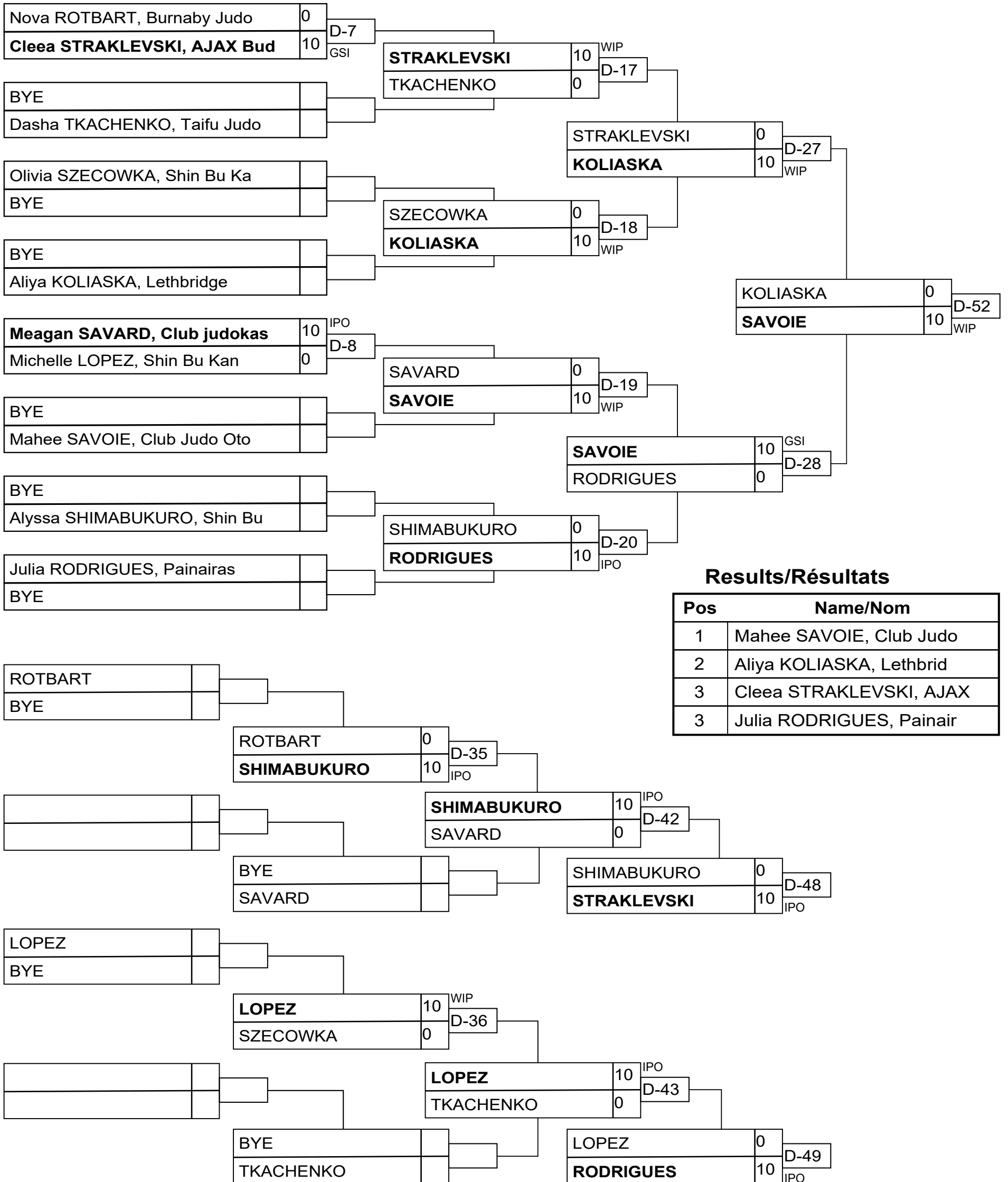

U16 Women -57kg

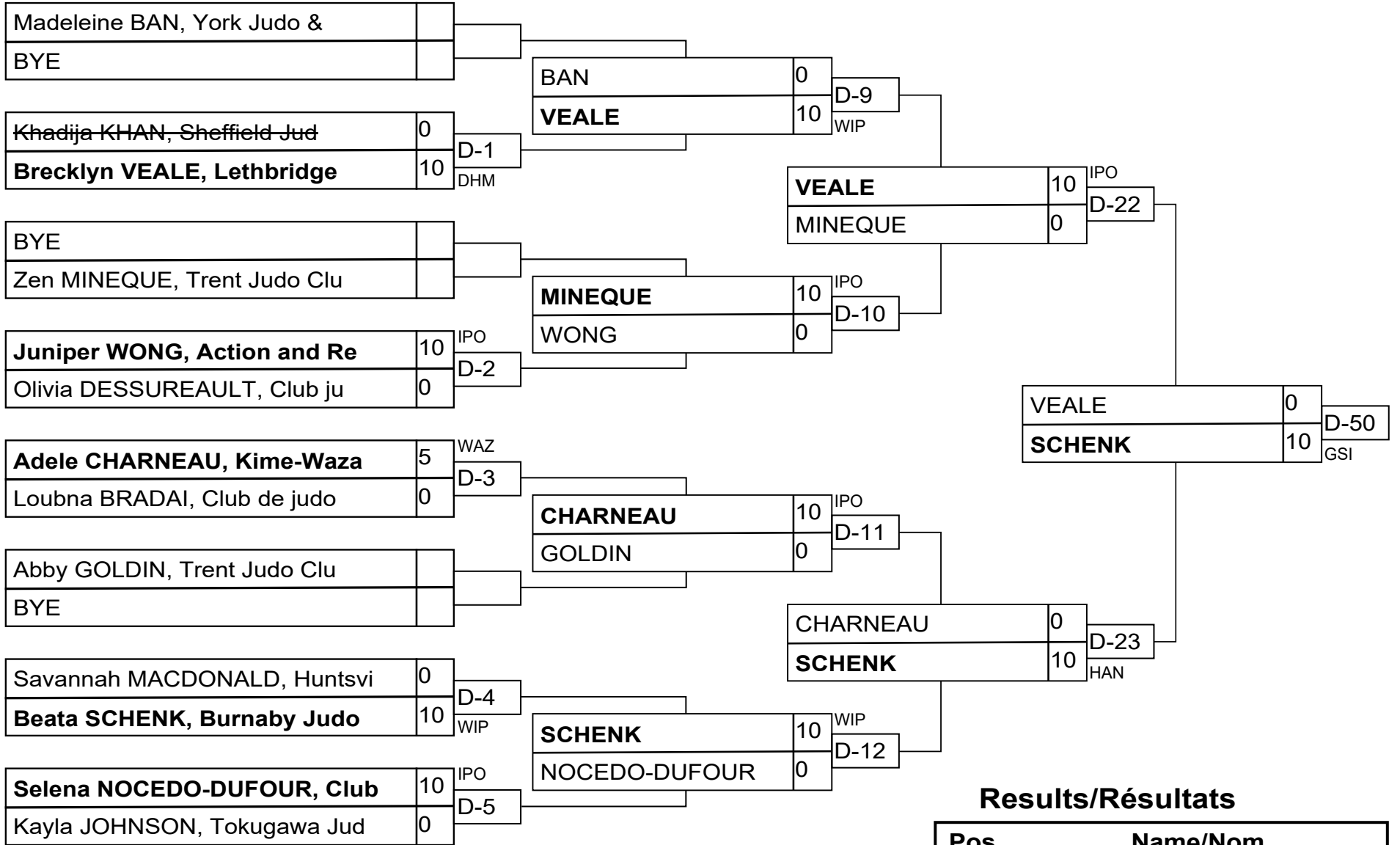

Results/Résultats

Pos	Name/Nom
1	Beata SCHENK, Burnaby Ju
2	Brecklyn VEALE, Lethbrid
3	Olivia DESSUREAULT, Club
3	Loubna BRADAI, Club de j

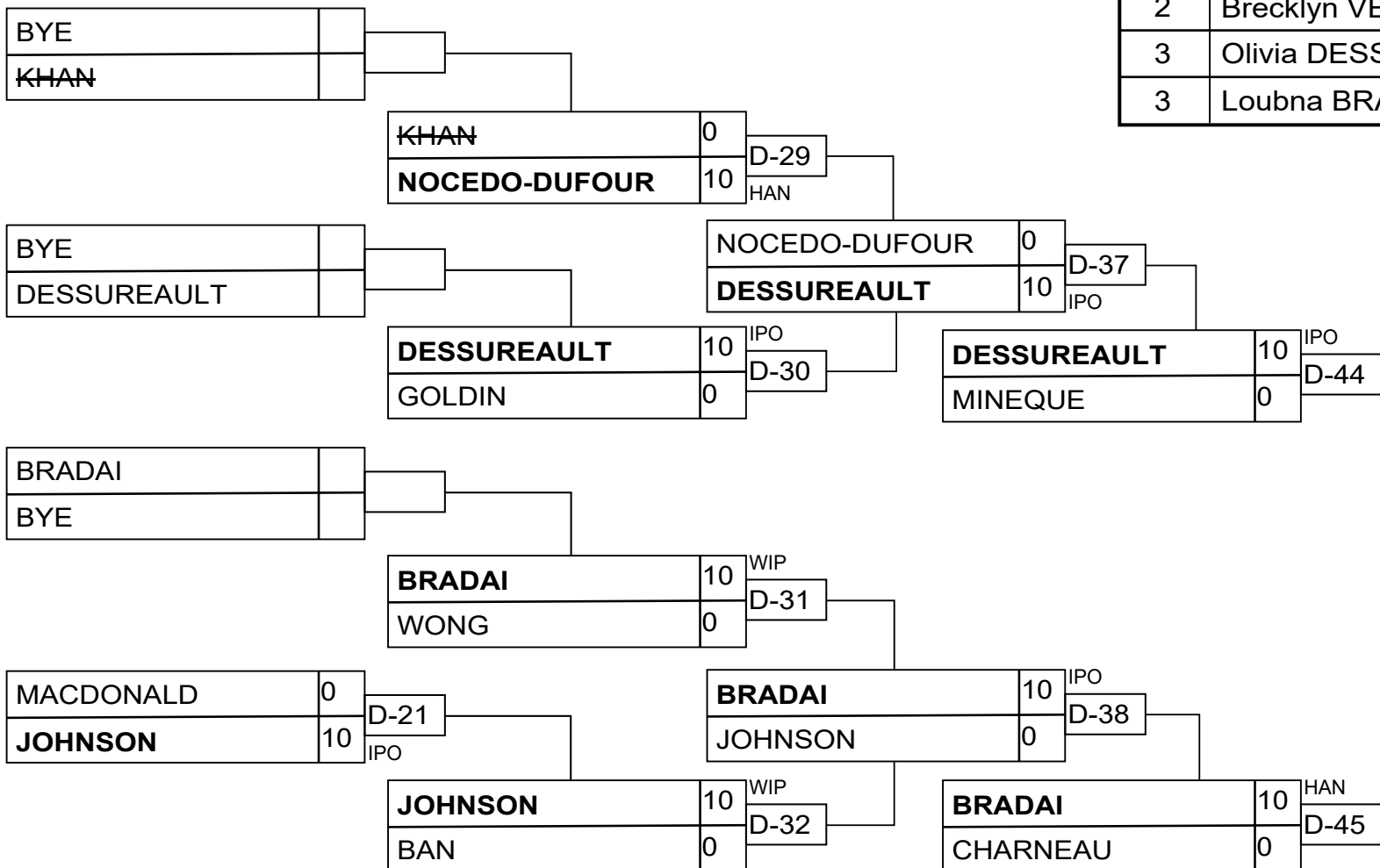

U16 Women -63kg

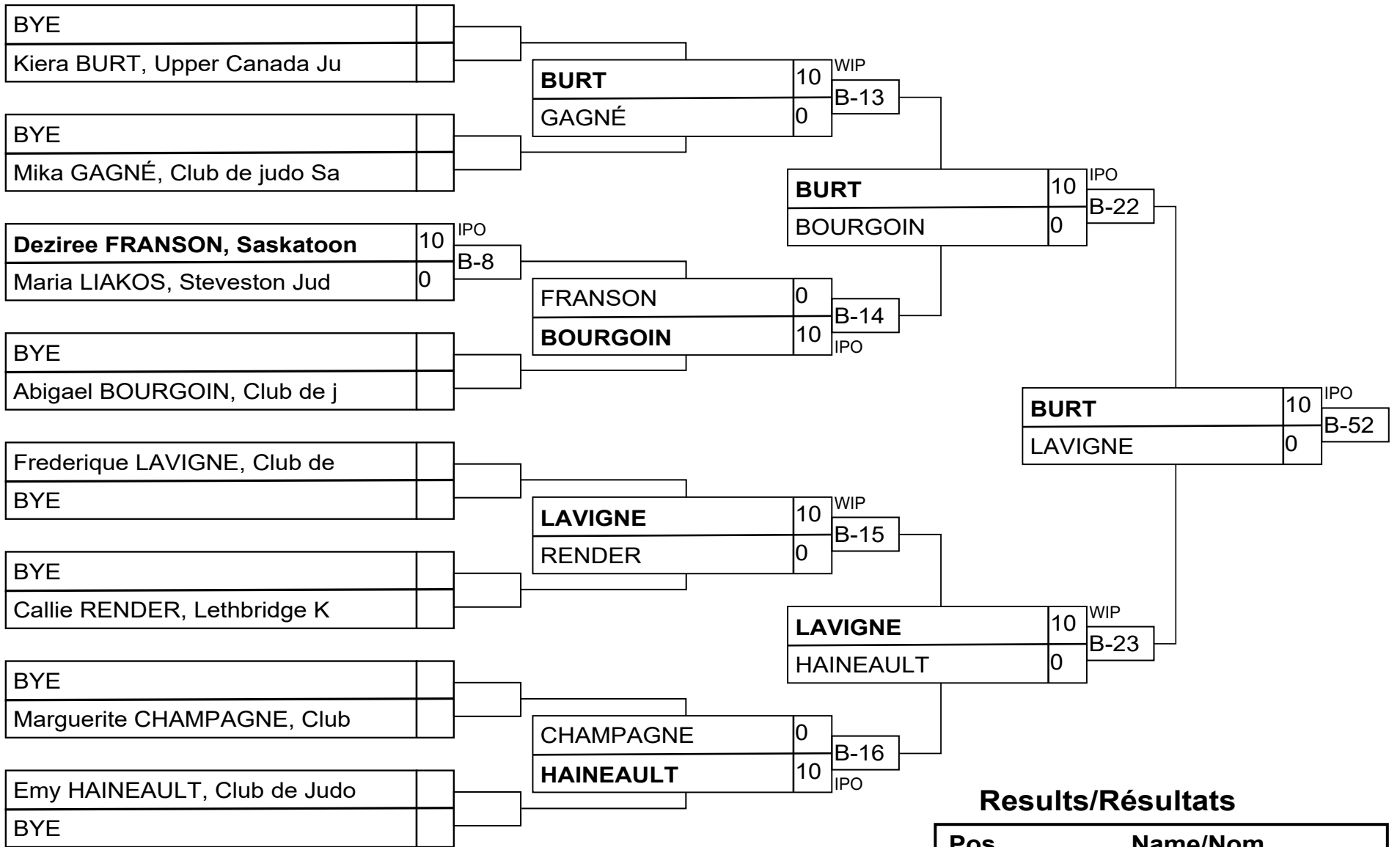

Results/Résultats

Pos	Name/Nom
1	Kiera BURT, Upper Canada
2	Frederique LAVIGNE, Club
3	Callie RENDER, Lethbridg
3	Deziree FRANSON, Saskato

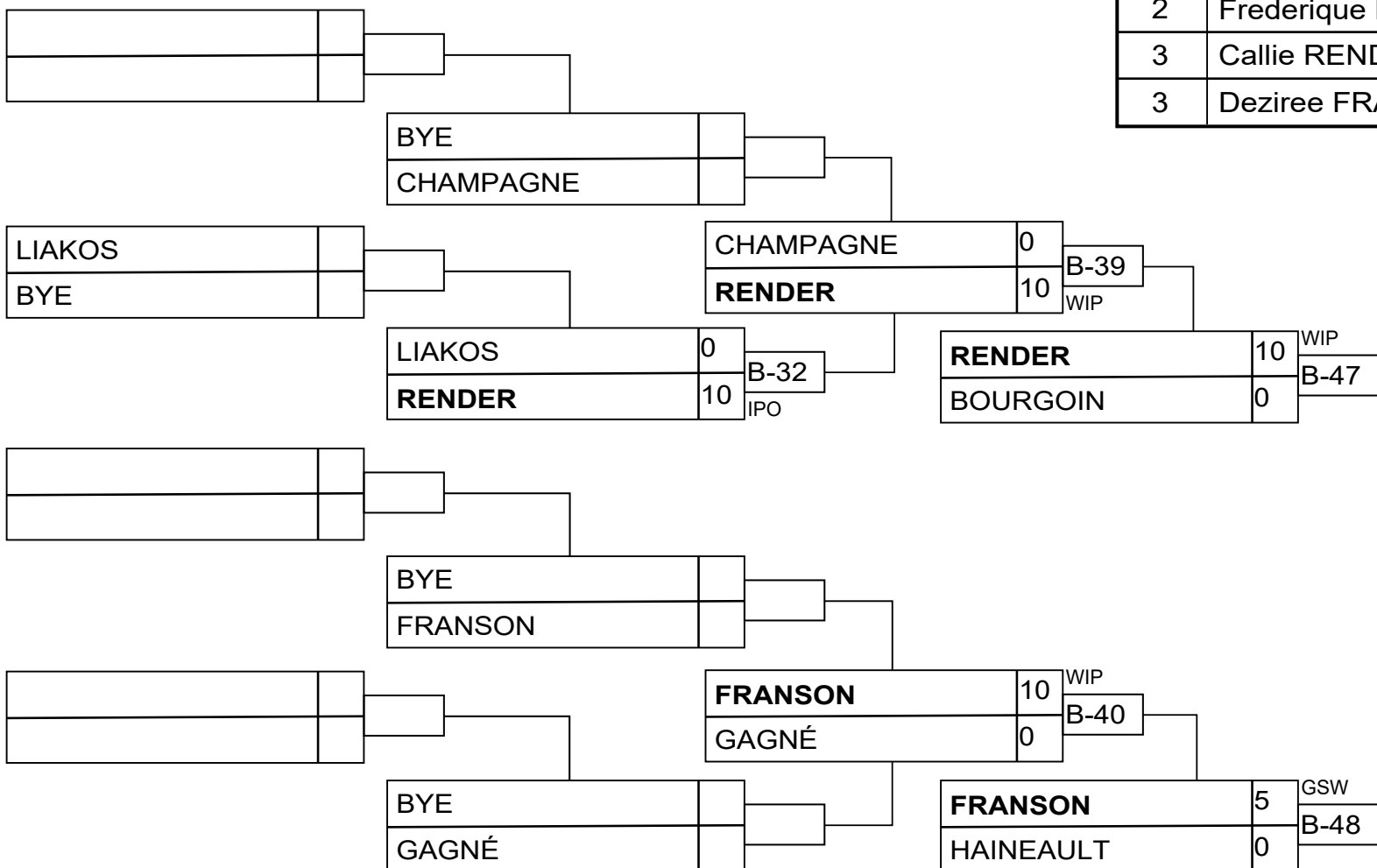

U16 Women -70kg

Competitors/Compétiteurs

#	Name/Nom	Grade	Club	1	2	3	W/G	Pts	Pos
1	Mattea SEITZ	Green	GP Martial Arts	XX			0	0	3
2	Miya VARSANYI	Green	Lethbridge Kyodokan Judo	10	XX		1	10	2
3	Alyssa BELLAVANCE	Blue	Club de judo Saint-Hyaci	10	10	XX	2	20	1

Matches/Matches

Match	White/Blanc			Blue/Bleu	Res/Rés	Tim/Tmp	Code
D-24	Mattea SEITZ	1	2	Miya VARSANYI	0 - 10	2:08	IPO
D-33	Mattea SEITZ	1	3	Alyssa BELLAVANCE	0 - 10	0:33	WIP
D-39	Miya VARSANYI	2	3	Alyssa BELLAVANCE	0 - 10	3:30	HAN

Results/Résultats

Pos	Name/Nom
1	Alyssa BELLAVANCE, Club de judo Saint-Hyacint
2	Miya VARSANYI, Lethbridge Kyodokan Judo Club

U16 Women +70kg

Competitors/Compétiteurs

#	Name/Nom	Grade	Club	1	2	3	W/G	Pts	Pos
1	Annabelle LIFSHITS	Green	Toronto Judo Kai	XX			0	0	3
2	Amy DARAICHE	Green	Club de judo Torakai	10	XX	10	2	20	1
3	Avery MCGARRY	Blue	Lloydminster Judo Club	10		XX	1	10	2

Matches/Matches

Match	White/Blanc			Blue/Bleu	Res/Rés	Tim/Tmp	Code
B-24	Annabelle LIFSHITS	1	2	Amy DARAICHE	0 - 10	1:06	IPO
B-33	Annabelle LIFSHITS	1	3	Avery MCGARRY	0 - 10	0:59	IPO
B-41	Amy DARAICHE	2	3	Avery MCGARRY	10 - 0	1:39	WIP

Results/Résultats

Pos	Name/Nom
1	Amy DARAICHE, Club de judo Torakai
2	Avery MCGARRY, Lloydminster Judo Club