

# NeWazaMenDiffAbled Light

## Competitors/Compétiteurs

#	Name/Nom	Grade	Club	1	2	1	2	1	2	W/G	Pts	Pos
1	Andrei OUDOVIKINE	Brown	Taifu Judo Club	XX	5	XX	10	XX		2	15	1
2	Andreas VLAD	Brown	Taifu Judo Club		XX		XX		XX	0	0	2

## Matches/Matches

Match	White/Blanc			Blue/Bleu	Res/Rés	Tim/Tmp	Code
B-6	<b>Andrei OUDOVIKINE</b>	1	2	Andreas VLAD	5 - 0	4:00	WAZ
B-12	Andreas VLAD	2	1	<b>Andrei OUDOVIKINE</b>	0 - 10	3:17	HAN
B-18	Andrei OUDOVIKINE	1	2	Andreas VLAD			

## Results/Résultats

Pos	Name/Nom
1	Andrei OUDOVIKINE, Taifu Judo Club

# Senior Ne Waza Men -100kg

## Competitors/Compétiteurs

#	Name/Nom	Grade	Club	1	2	3	4	W/G	Pts	Pos
1	Elie Georges Sede DAVID-GN	Brown	Trent Judo Club	XX		5		1	5	3
2	Terry ST LOUIS	Brown	Sho Jin Judo Club	10	XX			1	10	2
3	Christopher DUBE	Brown	R.A Judo Club		5	XX		1	5	4
4	Gabriel RODRIGUES SERRA SI	Brown	Sheffield Judo Club	10	10	10	XX	3	30	1

## Matches/Matches

Match	White/Blanc			Blue/Bleu	Res/Rés	Tim/Tmp	Code
B-3	Elie Georges Sede DAVID-GNAHOUI	1	2	<b>Terry ST LOUIS</b>	0 - 10	4:00	IPO
B-4	Christopher DUBE	3	4	<b>Gabriel RODRIGUES SERRA SILVEIRA</b>	0 - 10	3:15	IPO
B-9	<b>Elie Georges Sede DAVID-GNAHOUI</b>	1	3	Christopher DUBE	5 - 0	4:00	WAZ
B-10	Terry ST LOUIS	2	4	<b>Gabriel RODRIGUES SERRA SILVEIRA</b>	0 - 10	1:04	IPO
B-15	Elie Georges Sede DAVID-GNAHOUI	1	4	<b>Gabriel RODRIGUES SERRA SILVEIRA</b>	0 - 10	2:46	IPO
B-16	Terry ST LOUIS	2	3	<b>Christopher DUBE</b>	0 - 5	4:00	WAZ

## Results/Résultats

Pos	Name/Nom
1	Gabriel RODRIGUES SERRA SILVEIRA, Sheffield J
2	Terry ST LOUIS, Sho Jin Judo Club
3	Elie Georges Sede DAVID-GNAHOUI, Trent Judo C
4	Christopher DUBE, R.A Judo Club

# Senior Ne Waza Men -81kg

## Competitors/Compétiteurs

#	Name/Nom	Grade	Club	1	2	3	W/G	Pts	Pos
1	Christopher VINSON	Shodan	K-W Judo	XX	10	10	2	20	1
2	Keaton CARMAN	Blue	Hayabusakan		XX	5	1	5	2
3	Braeden ARBOUR	Green	Trent Judo Club			XX	0	0	3

## Matches/Matches

Match	White/Blanc			Blue/Bleu	Res/Rés	Tim/Tmp	Code
B-2	Christopher VINSON	1	2	Keaton CARMAN	10 - 0	1:05	IPO
B-8	Christopher VINSON	1	3	Braeden ARBOUR	10 - 0	2:30	IPO
B-14	Keaton CARMAN	2	3	Braeden ARBOUR	5 - 0	4:00	WAZ

## Results/Résultats

Pos	Name/Nom
1	Christopher VINSON, K-W Judo
2	Keaton CARMAN, Hayabusakan

# Senior Ne Waza Men +100kg

## Competitors/Compétiteurs

#	Name/Nom	Grade	Club	1	W/G	Pts	Pos
1	Chris MUIRHEAD	Nidan	Huntsville Judo Club	XX	0	0	1

## Matches/Matches

Match	White/Blanc	Blue/Bleu	Res/Rés	Tim/Tmp	Code
-------	-------------	-----------	---------	---------	------

## Results/Résultats

Pos	Name/Nom

# Senior Ne Waza Women -70kg

## Competitors/Compétiteurs

#	Name/Nom	Grade	Club	1	2	3	4	W/G	Pts	Pos
1	Danique JANSSEN	Nidan	JC Hercules	XX		5	10	2	15	3
2	Shadeh EVANS	Blue	Tora Judo Club	10	XX		10	2	20	2
3	Katias YEE	Shodan	Annex Judo Academy		10	XX	10	2	20	1
4	Madeleine BAN	Green	York Judo & BJJ				XX	0	0	4

## Matches/Matches

Match	White/Blanc			Blue/Bleu	Res/Rés	Tim/Tmp	Code
A-3	Danique JANSSEN	1	2	<b>Shadeh EVANS</b>	0 - 10	1:47	IPO
A-4	<b>Katias YEE</b>	3	4	Madeleine BAN	10 - 0	0:08	HAN
A-8	<b>Danique JANSSEN</b>	1	3	Katias YEE	5 - 0	4:51	GSW
A-9	<b>Shadeh EVANS</b>	2	4	Madeleine BAN	10 - 0	2:38	IPO
A-19	<b>Danique JANSSEN</b>	1	4	Madeleine BAN	10 - 0	1:46	IPO
A-20	Shadeh EVANS	2	3	<b>Katias YEE</b>	0 - 10	0:24	IPO

## Results/Résultats

Pos	Name/Nom
1	Katias YEE, Annex Judo Academy
2	Shadeh EVANS, Tora Judo Club
3	Danique JANSSEN, JC Hercules

# U14 Men -34kg

## Competitors/Compétiteurs

#	Name/Nom	Grade	Club	1	2	3	4	W/G	Pts	Pos
1	Arel ROITMAN	Green	Taifu Judo Club	XX			5	1	5	3
2	Andrey MEJERY	Green	Taifu Judo Club	10	XX		10	2	20	2
3	Matthew SCHESNUIK	Blue	Toronto Judo Kai	10	10	XX	5	3	25	1
4	Ivan GRACHTCHOUK	Green	Challenge Sports Club				XX	0	0	4

## Matches/Matches

Match	White/Blanc			Blue/Bleu	Res/Rés	Tim/Tmp	Code
A-45	Arel ROITMAN	1	2	<b>Andrey MEJERY</b>	0 - 10	2:06	IPO
A-46	<b>Matthew SCHESNUIK</b>	3	4	Ivan GRACHTCHOUK	5 - 0	3:00	WAZ
A-56	Arel ROITMAN	1	3	<b>Matthew SCHESNUIK</b>	0 - 10	2:02	WIP
A-57	<b>Andrey MEJERY</b>	2	4	Ivan GRACHTCHOUK	10 - 0	0:52	WIP
A-65	<b>Arel ROITMAN</b>	1	4	Ivan GRACHTCHOUK	5 - 0	3:00	WAZ
A-66	Andrey MEJERY	2	3	<b>Matthew SCHESNUIK</b>	0 - 10	3:00	IPO

## Results/Résultats

Pos	Name/Nom
1	Matthew SCHESNUIK, Toronto Judo Kai
2	Andrey MEJERY, Taifu Judo Club
3	Arel ROITMAN, Taifu Judo Club

# U14 Men -38kg

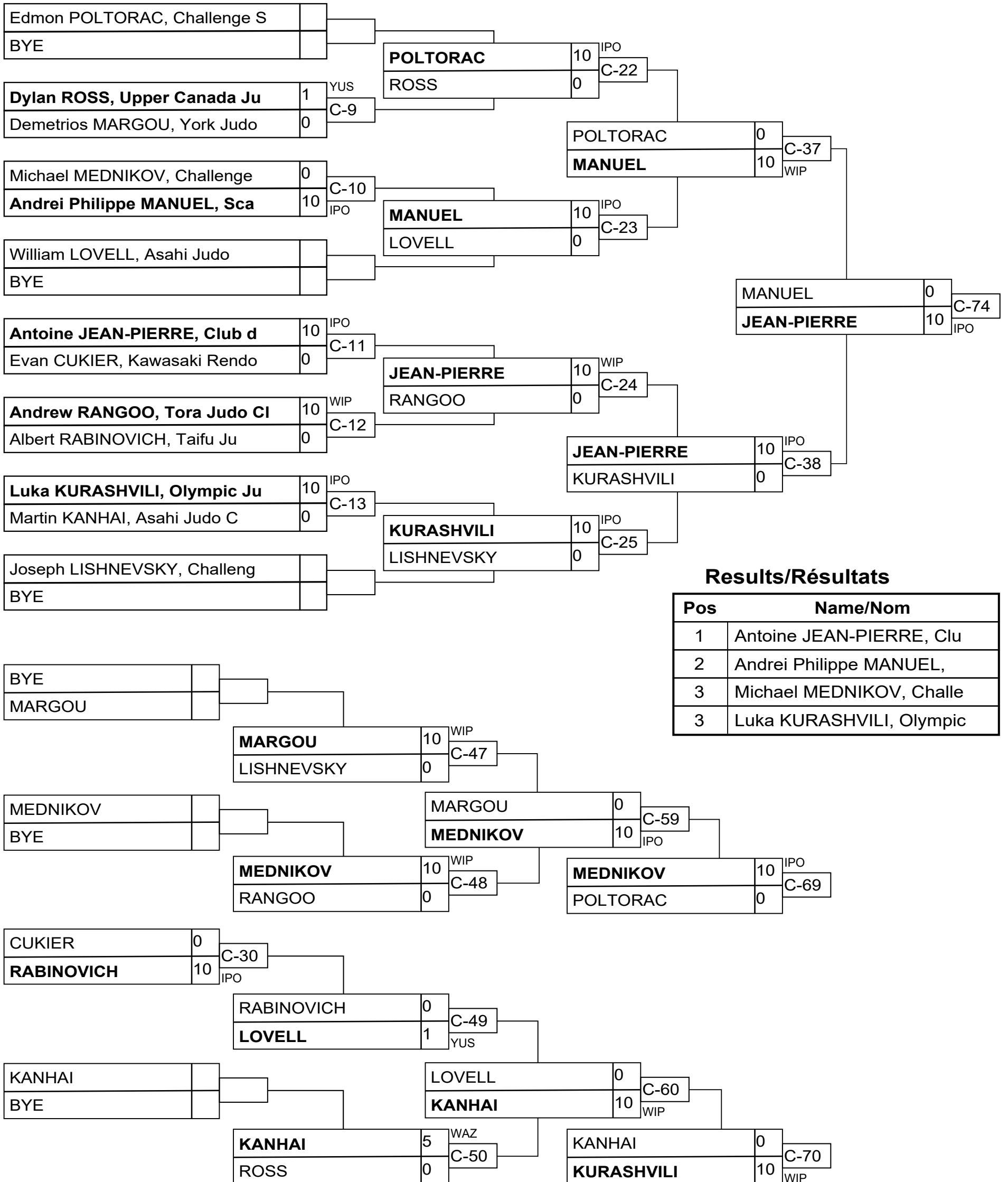

# U14 Men -42kg

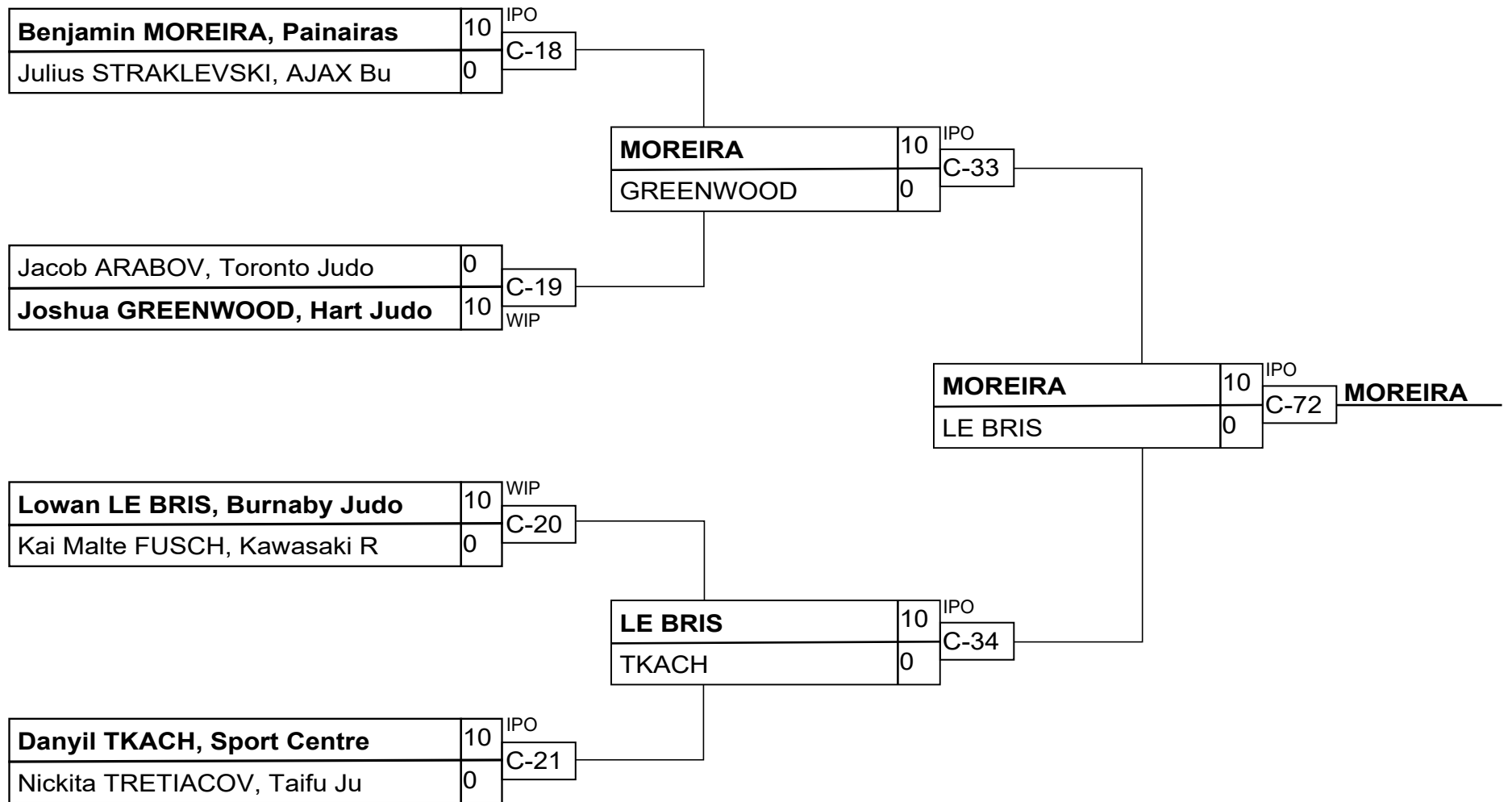

## Results/Résultats

Pos	Name/Nom
1	Benjamin MOREIRA, Painai
2	Lowan LE BRIS, Burnaby J
3	Nickita TRETIACOV, Taifu
3	Jacob ARABOV, Toronto Ju

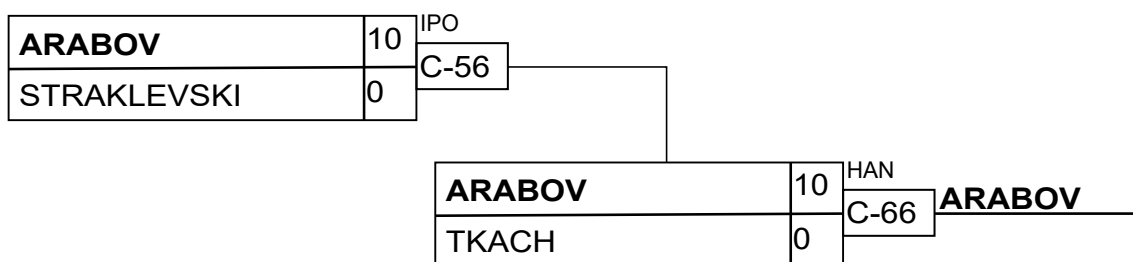
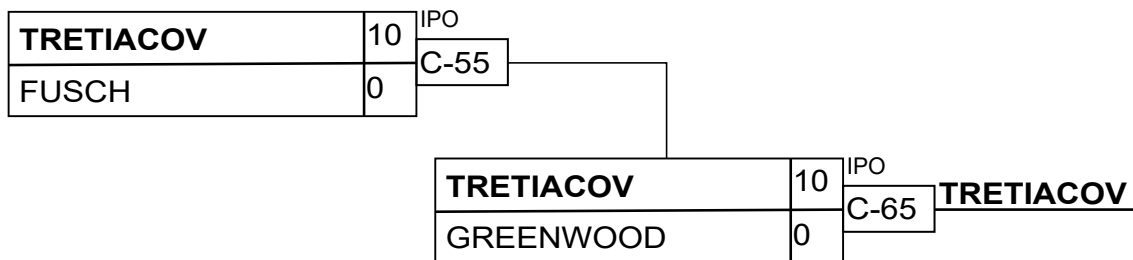



## Competitors/Compétiteurs A

#	Name/Nom	Grade	Club	1	2	3	W/G	Pts	Pos
1	Nick KASICH	Green	Taifu Judo Club	XX	10		1	10	2
2	Rayden ZELENKA	Green	AJAX Budokan		XX		0	0	3
3	Caio DE LIMA	Green	Painairas	10	10	XX	2	20	1

## Pool A

Match	White/Blanc	Blue/Bleu	Res/Rés	Tim/Tmp	Code
B-41	Nick KASICH 1 2	Rayden ZELENKA	10 - 0	1:28	WIP
B-53	Nick KASICH 1 3	Caio DE LIMA	0 - 10	2:40	WIP
B-59	Rayden ZELENKA 2 3	Caio DE LIMA	0 - 10	1:41	IPO

## Competitors/Compétiteurs B

#	Name/Nom	Grade	Club	4	5	6	W/G	Pts	Pos
4	Reinis REXHEPI	Green	Hayabusakan	XX	10		1	10	2
5	Corey D'ARTERIO	Green	Dojo Perrot Shima		XX		0	0	3
6	Elisey SOKOLOV	Green	Taifu Judo Club	10	10	XX	2	20	1

## Pool B

Match	White/Blanc	Blue/Bleu	Res/Rés	Tim/Tmp	Code
B-42	Reinis REXHEPI 4 5	Corey D'ARTERIO	10 - 0	2:02	IPO
B-54	Reinis REXHEPI 4 6	Elisey SOKOLOV	0 - 10	0:45	WIP
B-60	Corey D'ARTERIO 5 6	Elisey SOKOLOV	0 - 10	0:14	IPO

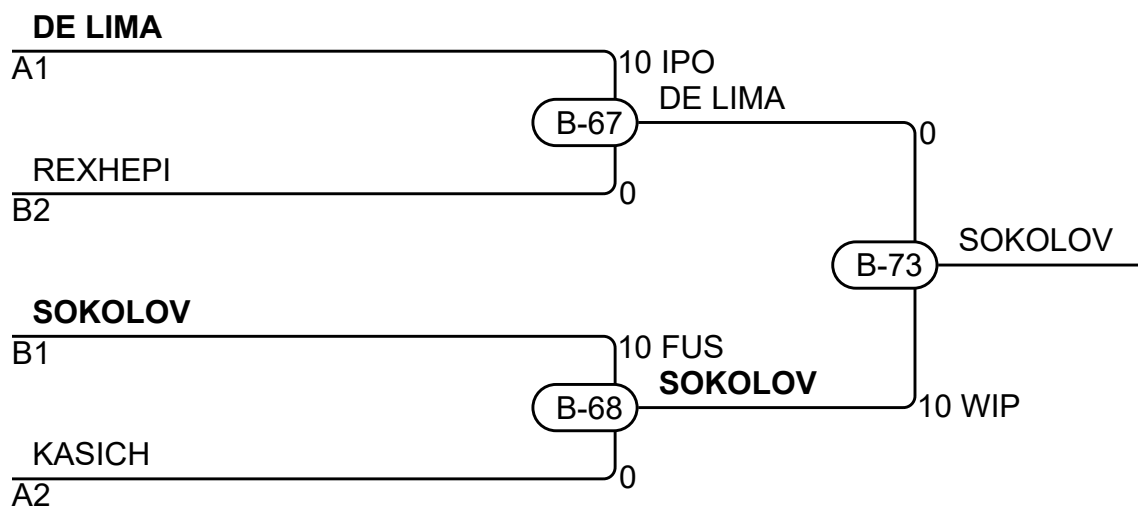

## Results/Résultats

Pos	Name/Nom
1	Elisey SOKOLOV, Taifu Judo Club
2	Caio DE LIMA, Painairas
3	Reinis REXHEPI, Hayabusakan
3	Nick KASICH, Taifu Judo Club

# U14 Men -50kg

## Competitors/Compétiteurs

#	Name/Nom	Grade	Club	1	2	3	4	5	W/G	Pts	Pos
1	Davit UKHURGUNASHVILI	Green	Olympic Judo Centre	XX					0	0	5
2	Felipe CALIL	Green	Painairas	10	XX	10		10	3	30	2
3	Gustavo PACINI	Green	Otto	10		XX		5	2	15	3
4	Shon TANSKY	Green	Taifu Judo Club	10	10	10	XX	1	4	31	1
5	Alex UDEBASHVILI	Green	Taifu Judo Club	10				XX	1	10	4

## Matches/Matches

Match	White/Blanc			Blue/Bleu	Res/Rés	Tim/Tmp	Code
D-25	<b>Shon TANSKY</b>	4	5	Alex UDEBASHVILI	1 - 0	6:00	YUS
D-26	Davit UKHURGUNASHVILI	1	2	<b>Felipe CALIL</b>	0 - 10	0:01	HAN
D-30	Gustavo PACINI	3	4	<b>Shon TANSKY</b>	0 - 10	0:14	IPO
D-31	Davit UKHURGUNASHVILI	1	5	<b>Alex UDEBASHVILI</b>	0 - 10	0:11	IPO
D-39	<b>Felipe CALIL</b>	2	3	Gustavo PACINI	10 - 0	2:42	IPO
D-40	Davit UKHURGUNASHVILI	1	4	<b>Shon TANSKY</b>	0 - 10	0:17	IPO
D-52	<b>Gustavo PACINI</b>	3	5	Alex UDEBASHVILI	5 - 0	3:00	WAZ
D-53	Felipe CALIL	2	4	<b>Shon TANSKY</b>	0 - 10	0:39	WIP
D-62	Davit UKHURGUNASHVILI	1	3	<b>Gustavo PACINI</b>	0 - 10	0:00	FUS
D-63	<b>Felipe CALIL</b>	2	5	Alex UDEBASHVILI	10 - 0	1:21	IPO

## Results/Résultats

Pos	Name/Nom
1	Shon TANSKY, Taifu Judo Club
2	Felipe CALIL, Painairas
3	Gustavo PACINI, Otto
4	Alex UDEBASHVILI, Taifu Judo Club

# U14 Men -55kg

## Competitors/Compétiteurs

#	Name/Nom	Grade	Club	1	2	1	2	1	2	W/G	Pts	Pos
1	Gabe NAKAMURA	Green	Takahashi Dojo	XX	10	XX		XX	10	2	20	1
2	Vincent MAHZOUNI	Green	AJAX Budokan		XX	10	XX		XX	1	10	2

## Matches/Matches

Match	White/Blanc			Blue/Bleu	Res/Rés	Tim/Tmp	Code
C-39	<b>Gabe NAKAMURA</b>	1	2	Vincent MAHZOUNI	10 - 0	0:19	IPO
C-51	<b>Vincent MAHZOUNI</b>	2	1	Gabe NAKAMURA	10 - 0	0:13	IPO
C-61	<b>Gabe NAKAMURA</b>	1	2	Vincent MAHZOUNI	10 - 0	0:24	IPO

## Results/Résultats

Pos	Name/Nom
1	Gabe NAKAMURA, Takahashi Dojo
2	Vincent MAHZOUNI, AJAX Budokan

# U14 Men -60kg

## Competitors/Compétiteurs

#	Name/Nom	Grade	Club	1	2	3	W/G	Pts	Pos
1	Mikhail PEREGORODIEV	Green	Taifu Judo Club	XX	10		1	10	2
2	Joshua T. ZAPATA-BURKE	Green	AJAX Budokan		XX		0	0	3
3	Lucas DELLAQUILA	Green	Painairas	10	10	XX	2	20	1

## Matches/Matches

Match	White/Blanc			Blue/Bleu	Res/Rés	Tim/Tmp	Code
E-38	<b>Mikhail PEREGORODIEV</b>	1	2	Joshua T. ZAPATA-BURKE	10 - 0	0:18	IPO
E-54	Mikhail PEREGORODIEV	1	3	<b>Lucas DELLAQUILA</b>	0 - 10	3:00	HAN
E-66	Joshua T. ZAPATA-BURKE	2	3	<b>Lucas DELLAQUILA</b>	0 - 10	0:12	IPO

## Results/Résultats

Pos	Name/Nom
1	Lucas DELLAQUILA, Painairas
2	Mikhail PEREGORODIEV, Taifu Judo Club

# U14 Men -66kg

## Competitors/Compétiteurs

#	Name/Nom	Grade	Club	1	W/G	Pts	Pos
1	Benjamin CHARRETTON-DELAGRE	Green	Kiseki Judo	XX	0	0	1

## Matches/Matches

Match	White/Blanc	Blue/Bleu	Res/Rés	Tim/Tmp	Code
-------	-------------	-----------	---------	---------	------

## Results/Résultats

Pos	Name/Nom

# U14 Women -40kg

## Competitors/Compétiteurs

#	Name/Nom	Grade	Club	1	2	3	W/G	Pts	Pos
1	Alexandrea FLORES	Blue	Tora Judo Club	XX	10		1	10	2
2	Alexia FIAES	Green	Tora Judo Club		XX		0	0	3
3	Leanna AU	Green	Burnaby Judo Club	10	10	XX	2	20	1

## Matches/Matches

Match	White/Blanc			Blue/Bleu	Res/Rés	Tim/Tmp	Code
D-36	<b>Alexandrea FLORES</b>	1	2	Alexia FIAES	10 - 0	0:47	IPO
D-50	Alexandrea FLORES	1	3	<b>Leanna AU</b>	0 - 10	2:01	IPO
D-59	Alexia FIAES	2	3	<b>Leanna AU</b>	0 - 10	0:28	WIP

## Results/Résultats

Pos	Name/Nom
1	Leanna AU, Burnaby Judo Club
2	Alexandrea FLORES, Tora Judo Club

# U14 Women -44kg

## Competitors/Compétiteurs A

#	Name/Nom	Grade	Club	1	2	3	W/G	Pts	Pos
1	Alexandra MORRA	Green	Upper Canada Judo Club	XX	10	10	2	20	1
2	Chloe LISSITSAS	Green	Toronto Judo Kai		XX	10	1	10	2
3	Alythea KARSERAS	Green	Takahashi Dojo			XX	0	0	3

## Pool A

Match	White/Blanc	Blue/Bleu	Res/Rés	Tim/Tmp	Code
C-35	Alexandra MORRA	1 2 Chloe LISSITSAS	10 - 0	2:07	HAN
C-45	Alexandra MORRA	1 3 Alythea KARSERAS	10 - 0	1:22	WIP
C-57	Chloe LISSITSAS	2 3 Alythea KARSERAS	10 - 0	1:40	IPO

## Competitors/Compétiteurs B

#	Name/Nom	Grade	Club	4	5	6	W/G	Pts	Pos
4	Angelia PAPADATOS	Green	Toronto Judo Kai	XX			0	0	3
5	Dilana GESA	Green	Battle Arts Academy	10	XX	10	2	20	1
6	Myla BLACKSHAW	Green	Asahi Judo Club	10		XX	1	10	2

## Pool B

Match	White/Blanc	Blue/Bleu	Res/Rés	Tim/Tmp	Code
C-36	Angelia PAPADATOS	4 5 Dilana GESA	0 - 10	1:21	IPO
C-46	Angelia PAPADATOS	4 6 Myla BLACKSHAW	0 - 10	0:10	IPO
C-58	Dilana GESA	5 6 Myla BLACKSHAW	10 - 0	0:49	WIP

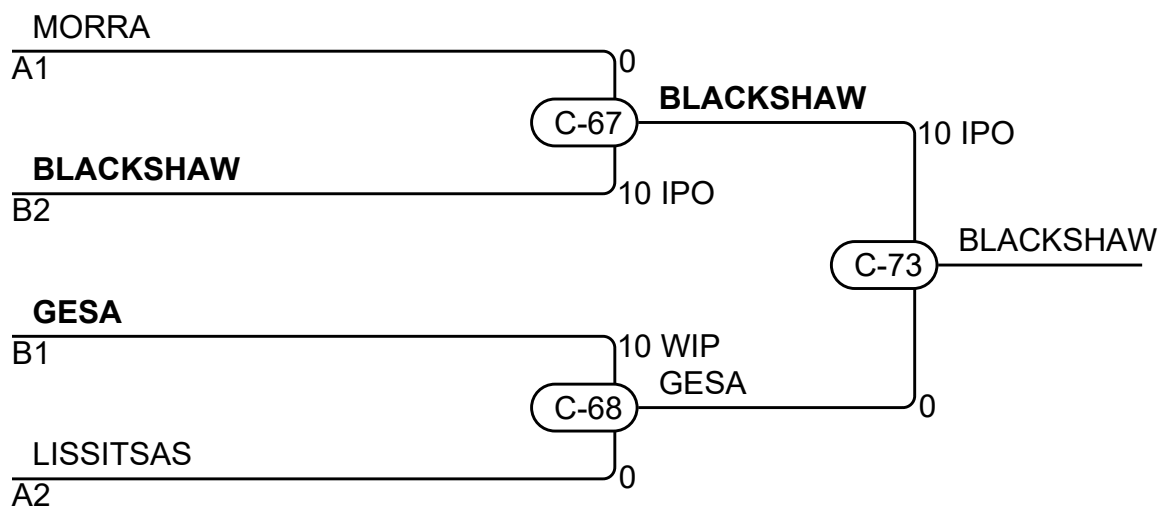

## Results/Résultats

Pos	Name/Nom
1	Myla BLACKSHAW, Asahi Judo Club
2	Dilana GESA, Battle Arts Academy
3	Alexandra MORRA, Upper Canada Judo Club
3	Chloe LISSITSAS, Toronto Judo Kai

# U14 Women -48kg

## Competitors/Compétiteurs

#	Name/Nom	Grade	Club	1	2	1	2	1	2	W/G	Pts	Pos
1	Emma OMMERT	Green	AJAX Budokan	XX		XX		XX		0	0	2
2	Kaylee LEWIS	Green	Dojo Perrot Shima	5	XX	10	XX		XX	2	15	1

## Matches/Matches

Match	White/Blanc			Blue/Bleu	Res/Rés	Tim/Tmp	Code
A-47	Emma OMMERT	1	2	<b>Kaylee LEWIS</b>	0 - 5	3:00	WAZ
A-58	<b>Kaylee LEWIS</b>	2	1	Emma OMMERT	10 - 0	0:00	KIK
A-67	Emma OMMERT	1	2	Kaylee LEWIS			

## Results/Résultats

Pos	Name/Nom
1	Kaylee LEWIS, Dojo Perrot Shima



# U14 Women -52kg

## Competitors/Compétiteurs

#	Name/Nom	Grade	Club	1	2	1	2	1	2	W/G	Pts	Pos
1	Emma PROULX-OLSON	Blue	Dojo Perrot Shima	XX	10	XX	10	XX		2	20	1
2	Alyssa TKACHENKO	Green	Taifu Judo Club		XX		XX		XX	0	0	2

## Matches/Matches

Match	White/Blanc			Blue/Bleu	Res/Rés	Tim/Tmp	Code
C-40	<b>Emma PROULX-OLSON</b>	1	2	Alyssa TKACHENKO	10 - 0	1:23	IPO
C-52	Alyssa TKACHENKO	2	1	<b>Emma PROULX-OLSON</b>	0 - 10	1:42	IPO
C-62	Emma PROULX-OLSON	1	2	Alyssa TKACHENKO			

## Results/Résultats

Pos	Name/Nom
1	Emma PROULX-OLSON, Dojo Perrot Shima

# U18 Men -46kg

## Competitors/Compétiteurs

#	Name/Nom	Grade	Club	1	2	3	4	5	W/G	Pts	Pos
1	Sazont BREZGIN	Blue	Toronto Judo Kai	XX	10				1	10	4
2	Peter VELONAS	Green	Abbotsford Judo Club		XX				0	0	5
3	Danill KREMERMANN	Blue	Sport Centre Ippon	10	10	XX	10	10	4	40	1
4	Denis NEYOLOV	Green	Taifu Judo Club	10	10		XX		2	20	3
5	Artem NEYOLOV	Green	Taifu Judo Club	5	10		10	XX	3	25	2

## Matches/Matches

Match	White/Blanc			Blue/Bleu	Res/Rés	Tim/Tmp	Code
E-20	Denis NEYOLOV	4	5	<b>Artem NEYOLOV</b>	0 - 10	2:16	WIP
E-21	<b>Sazont BREZGIN</b>	1	2	Peter VELONAS	10 - 0	1:12	IPO
E-25	<b>Danill KREMERMANN</b>	3	4	Denis NEYOLOV	10 - 0	0:46	WIP
E-26	Sazont BREZGIN	1	5	<b>Artem NEYOLOV</b>	0 - 5	4:00	WAZ
E-34	Peter VELONAS	2	3	<b>Danill KREMERMANN</b>	0 - 10	0:00	FUS
E-35	Sazont BREZGIN	1	4	<b>Denis NEYOLOV</b>	0 - 10	3:00	IPO
E-50	<b>Danill KREMERMANN</b>	3	5	Artem NEYOLOV	10 - 0	0:36	IPO
E-51	Peter VELONAS	2	4	<b>Denis NEYOLOV</b>	0 - 10	0:00	FUS
E-62	Sazont BREZGIN	1	3	<b>Danill KREMERMANN</b>	0 - 10	2:03	WIP
E-63	Peter VELONAS	2	5	<b>Artem NEYOLOV</b>	0 - 10	0:00	FUS

## Results/Résultats

Pos	Name/Nom
1	Danill KREMERMANN, Sport Centre Ippon
2	Artem NEYOLOV, Taifu Judo Club
3	Denis NEYOLOV, Taifu Judo Club
4	Sazont BREZGIN, Toronto Judo Kai

# U18 Men -50kg

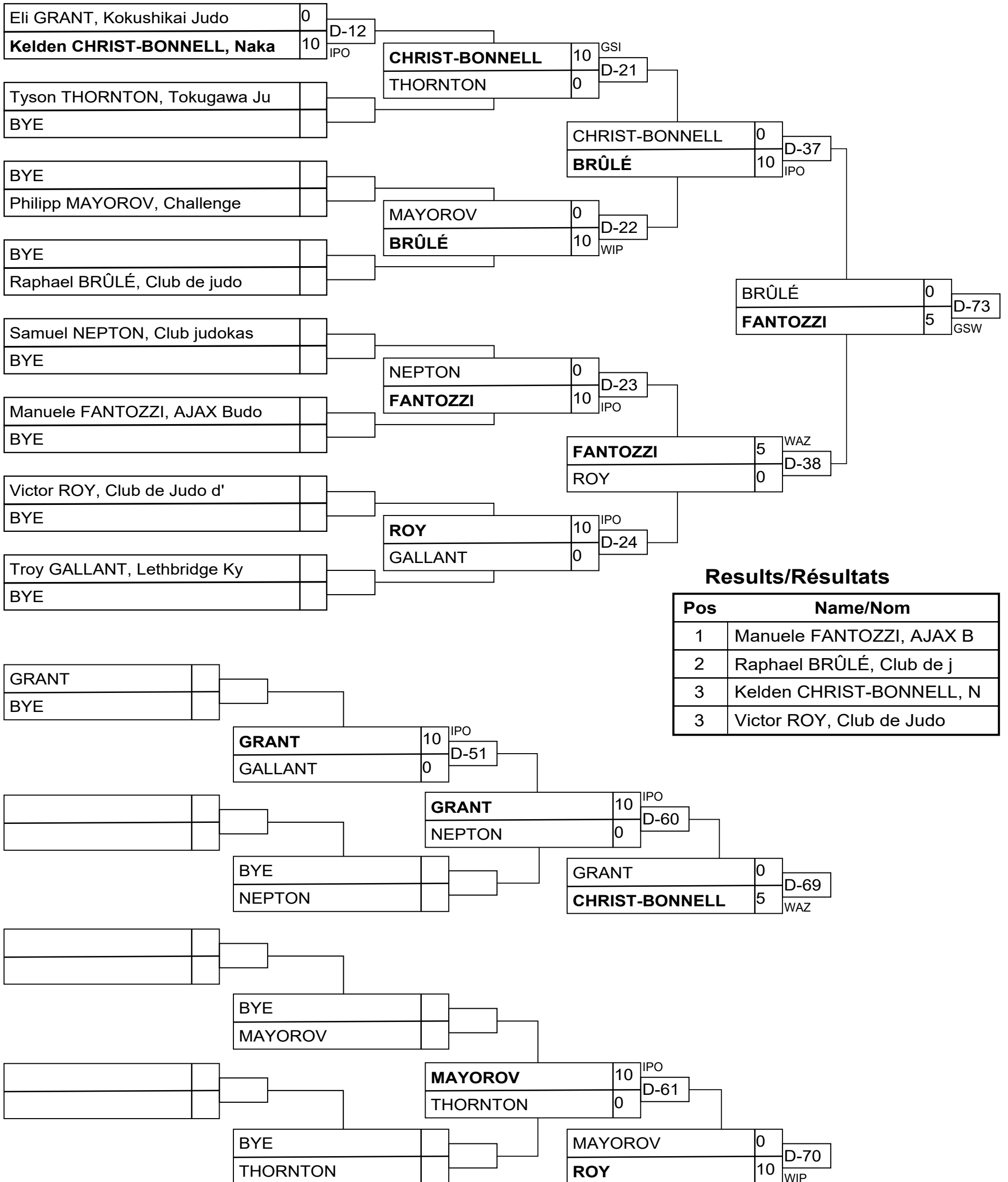



# U18 Men -60kg

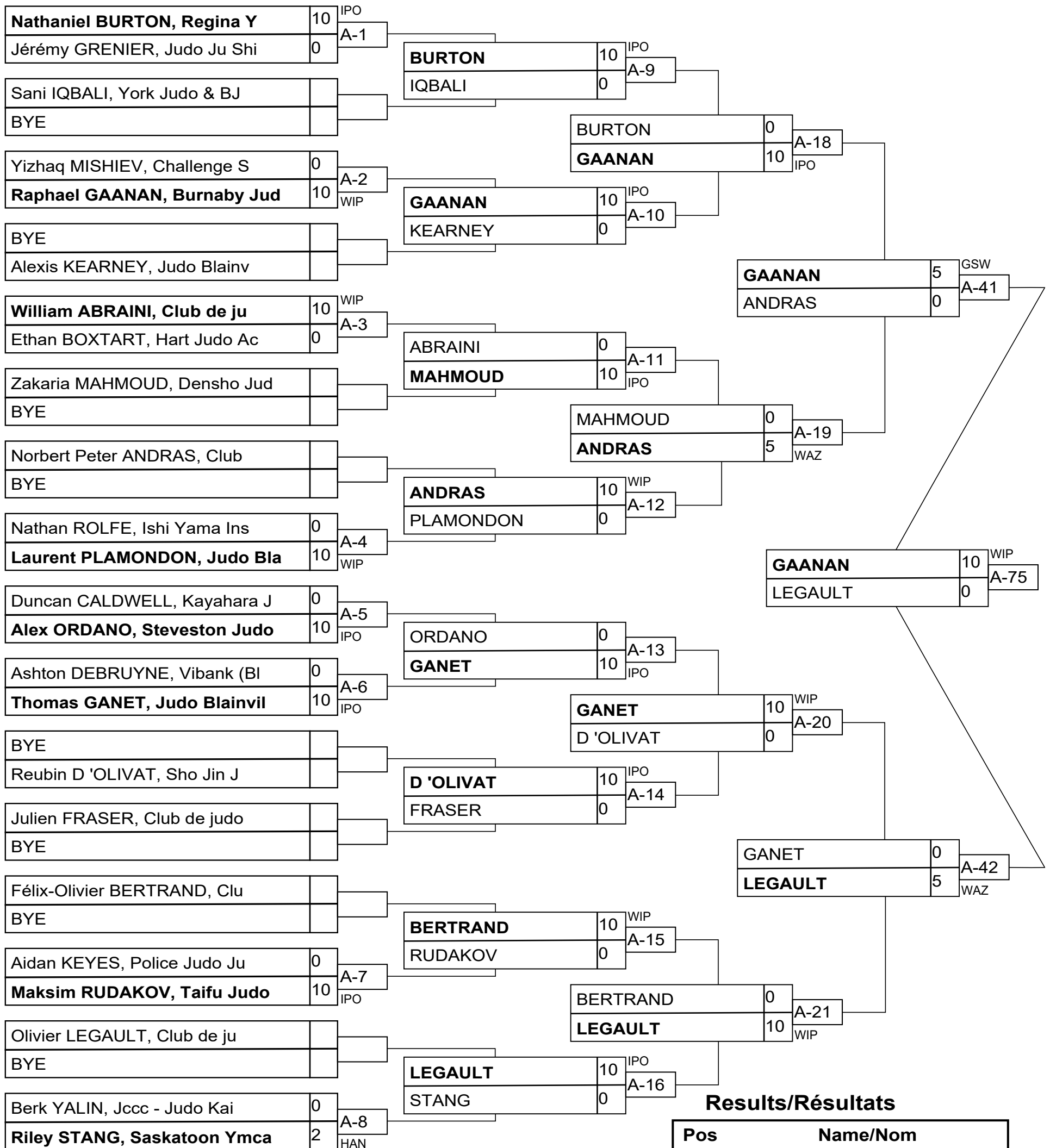

## Results/Résultats

Pos	Name/Nom
1	Raphael GAANAN, Burnaby
2	Olivier LEGAULT, Club de
3	Norbert Peter ANDRAS, CI
3	Thomas GANET, Judo Blain

# U18 Men -60kg

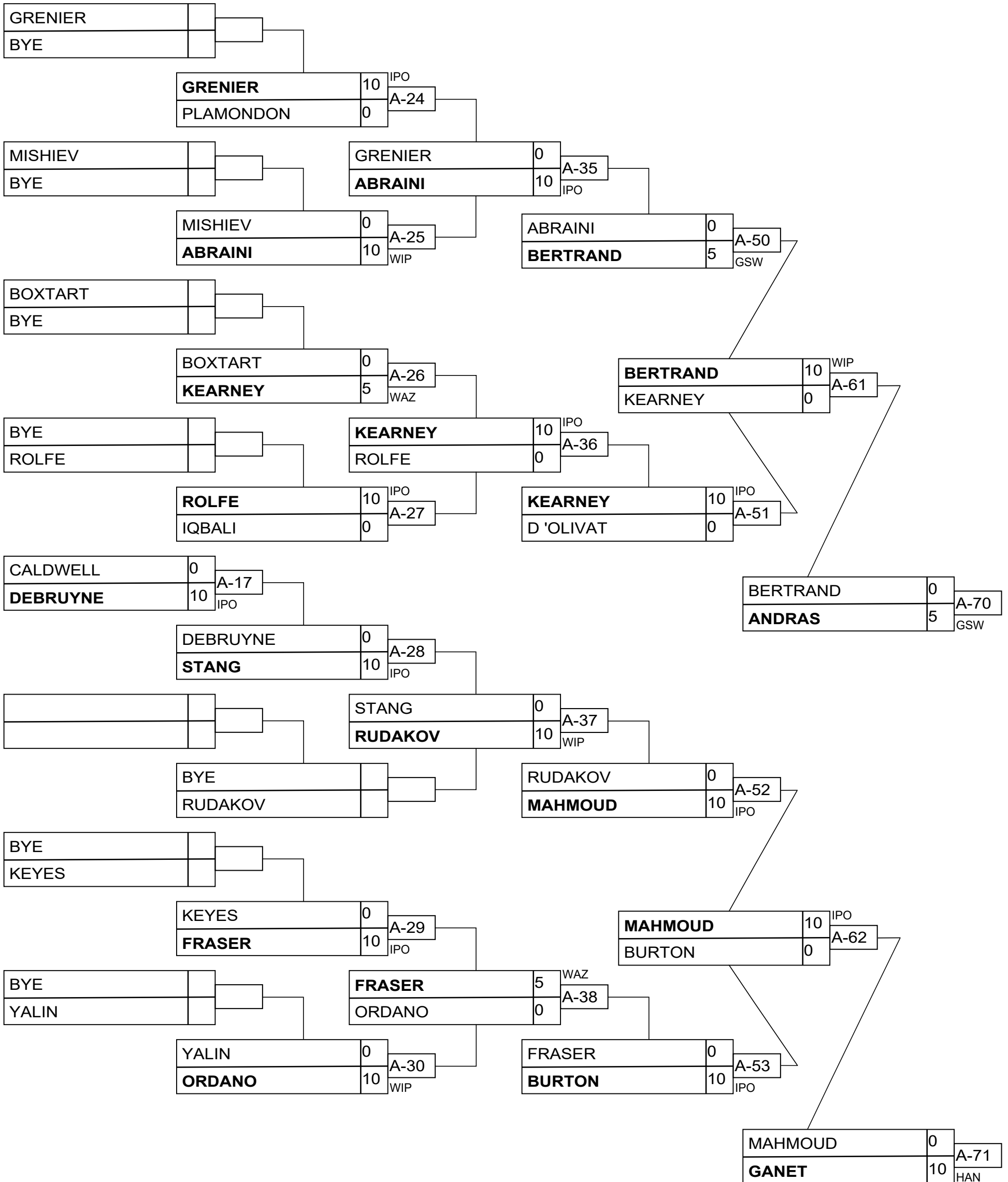

# U18 Men -66kg

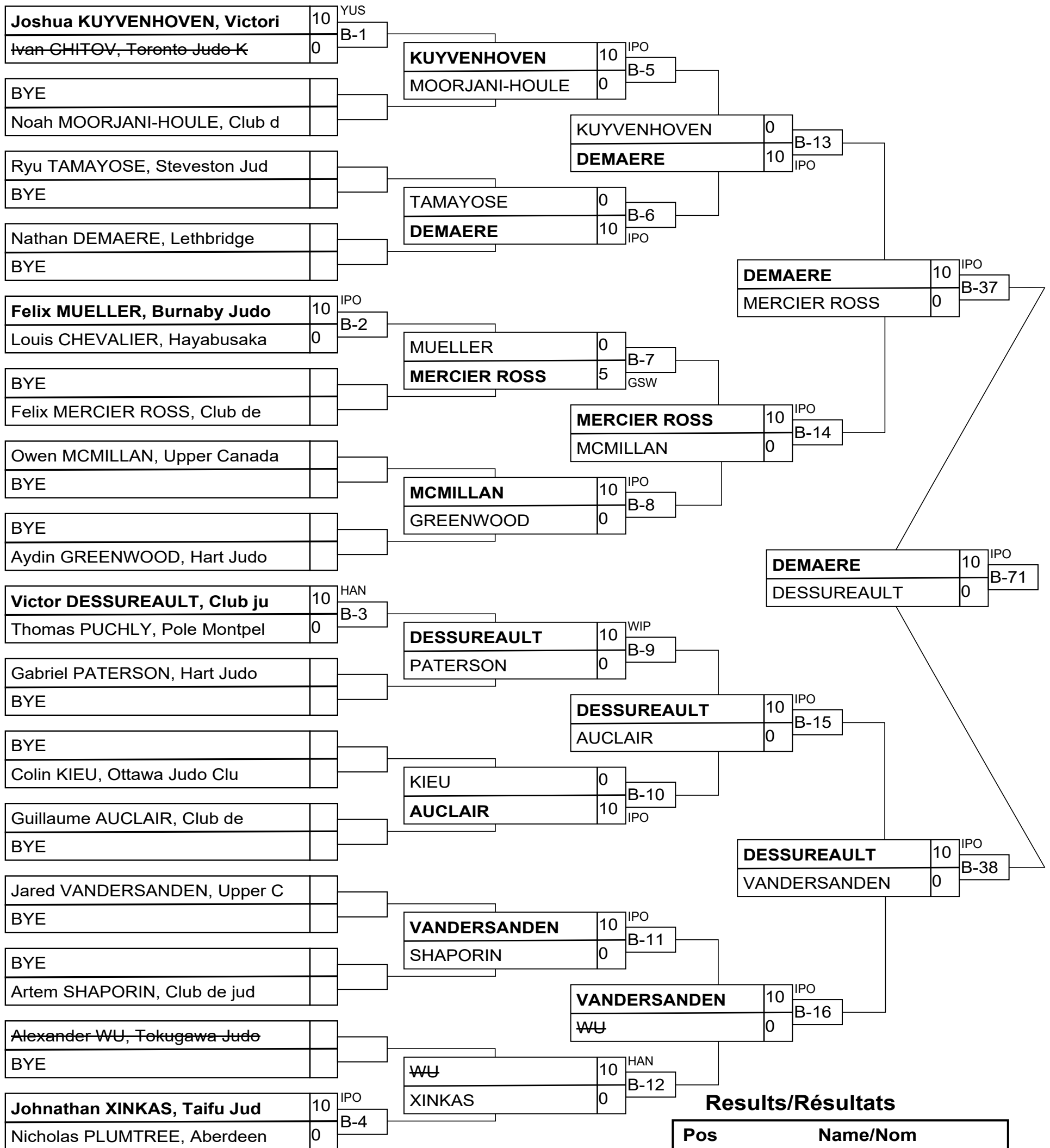

## Results/Résultats

Pos	Name/Nom
1	Nathan DEMAERE, Lethbrid
2	Victor DESSUREAULT, Club
3	Felix MERCIER ROSS, Club
3	Joshua KUYVENHOVEN, Vict

# U18 Men -66kg

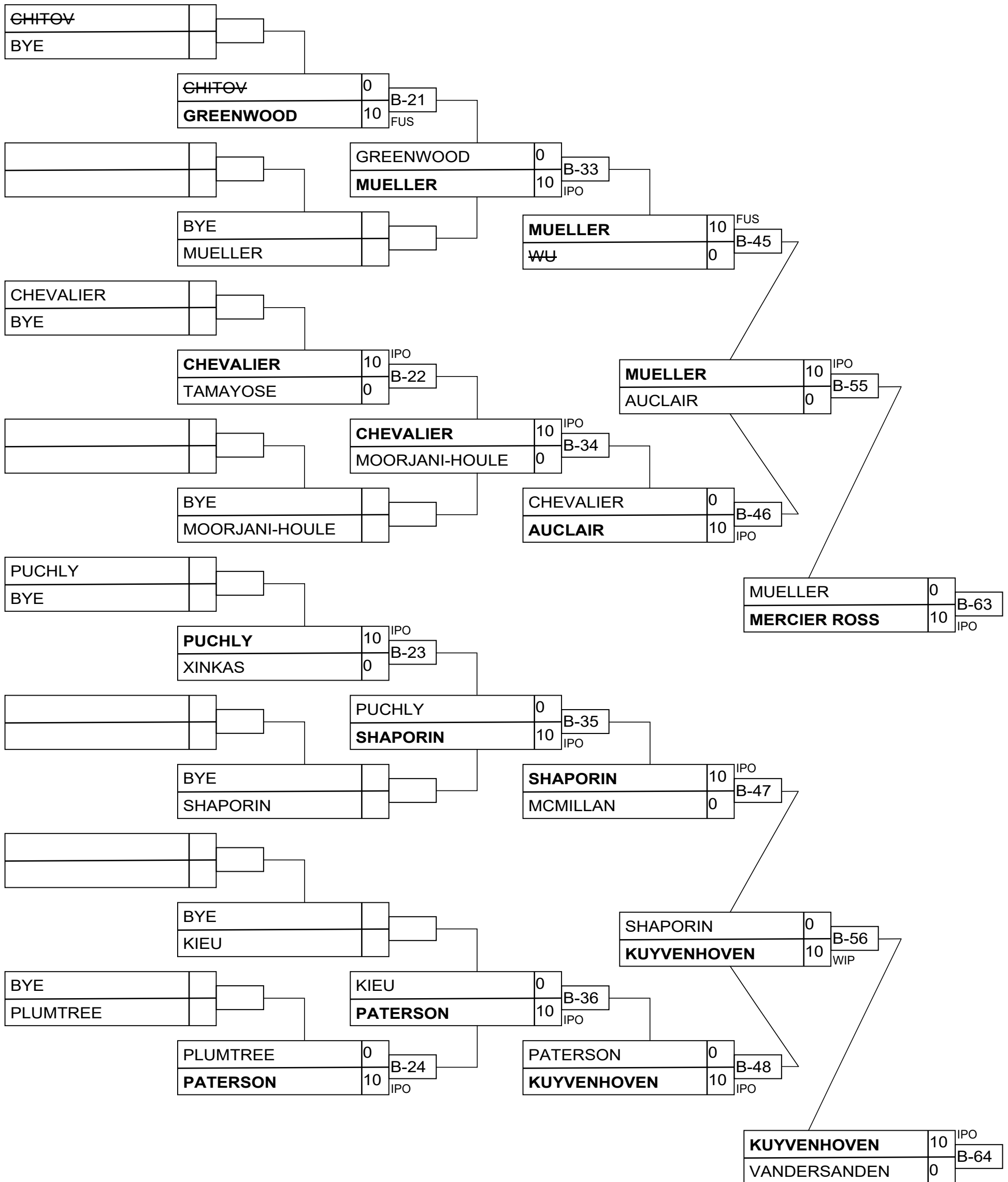



# U18 Men -73kg

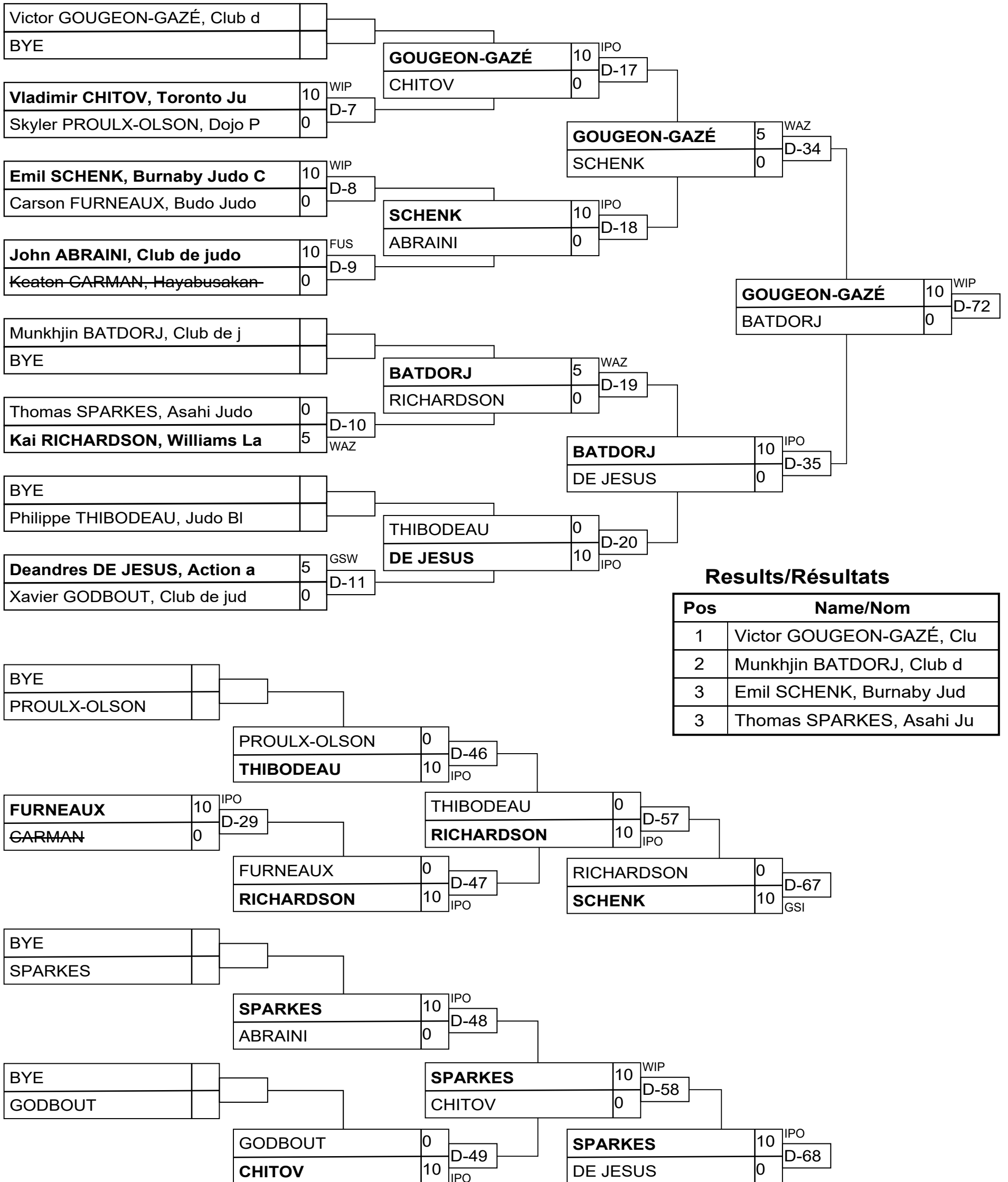

## Results/Résultats

Pos	Name/Nom
1	Victor GOUGEON-GAZÉ, Clu
2	Munkhjin BATDORJ, Club d
3	Emil SCHENK, Burnaby Jud
3	Thomas SPARKES, Asahi Ju

# U18 Men -81kg

## Competitors/Compétiteurs A

#	Name/Nom	Grade	Club	1	2	3	4	W/G	Pts	Pos
1	Andrew MICU	Brown	Hiro's Judo Club	XX			10	1	10	3
2	Nikola PETROVIC	Brown	Burnaby Judo Club	10	XX	10	10	3	30	1
3	Alec GARAND	Brown	Dojo Zenshin	10		XX	10	2	20	2
4	Dean HENDRY	Blue	Formokan Judo Club				XX	0	0	4

## Pool A

Match	White/Blanc	Blue/Bleu	Res/Rés	Tim/Tmp	Code
E-29	Andrew MICU 1 2	<b>Nikola PETROVIC</b>	0 - 10	3:36	HAN
E-30	<b>Alec GARAND</b> 3 4	Dean HENDRY	10 - 0	0:00	FUS
E-43	Andrew MICU 1 3	<b>Alec GARAND</b>	0 - 10	6:10	HAN
E-44	<b>Nikola PETROVIC</b> 2 4	Dean HENDRY	10 - 0	0:00	FUS
E-57	<b>Andrew MICU</b> 1 4	Dean HENDRY	10 - 0	0:00	FUS
E-58	<b>Nikola PETROVIC</b> 2 3	Alec GARAND	10 - 0	4:00	GSI

## Competitors/Compétiteurs B

#	Name/Nom	Grade	Club	5	6	7	W/G	Pts	Pos
5	Kenny BELLEMARE	Brown	Club de judo Seikidokan	XX			0	0	3
6	Nick LUCHKIN	Brown	Challenge Sports Club	10	XX		1	10	2
7	Leo ARENCIBIA	Brown	Club de judo Shidokan in	10	10	XX	2	20	1

## Pool B

Match	White/Blanc	Blue/Bleu	Res/Rés	Tim/Tmp	Code
E-31	Kenny BELLEMARE 5 6	<b>Nick LUCHKIN</b>	0 - 10	0:34	WIP
E-45	Kenny BELLEMARE 5 7	<b>Leo ARENCIBIA</b>	0 - 10	0:34	IPO
E-59	Nick LUCHKIN 6 7	<b>Leo ARENCIBIA</b>	0 - 10	3:21	WIP

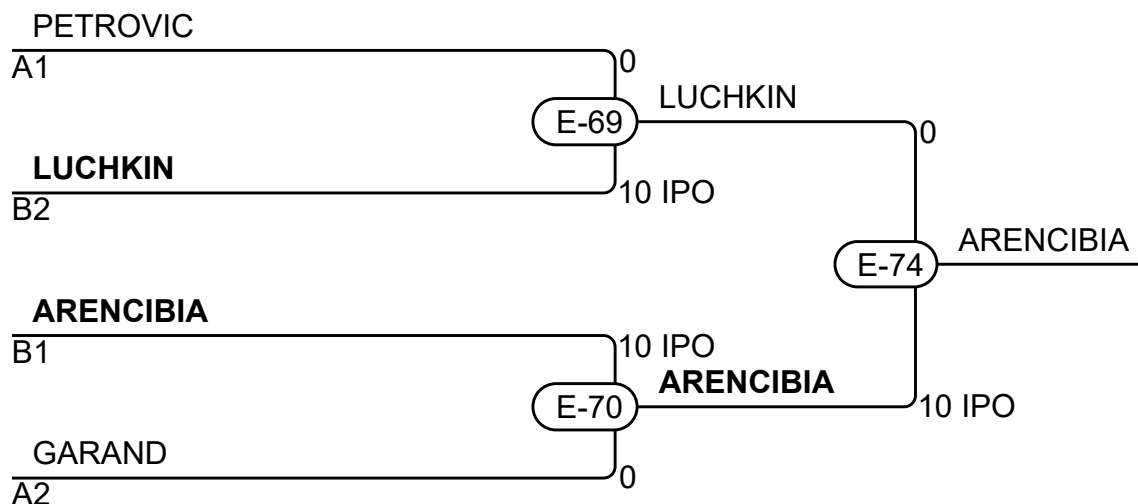

## Results/Résultats

Pos	Name/Nom
1	Leo ARENCIBIA, Club de judo Shidokan inc.
2	Nick LUCHKIN, Challenge Sports Club
3	Nikola PETROVIC, Burnaby Judo Club
3	Alec GARAND, Dojo Zenshin

## Competitors/Compétiteurs A

#	Name/Nom	Grade	Club	1	2	3	W/G	Pts	Pos
1	Elias LOUAHLA	Brown	Club de judo Métropolita	XX			0	0	3
2	Michael AKBASHEV	Shodan	West Kildonan Judo Club	10	XX	10	2	20	1
3	Owen MACUMBER	Brown	Ryudokan Judo Club	10		XX	1	10	2

## Pool A

Match	White/Blanc	Blue/Bleu	Res/Rés	Tim/Tmp	Code
A-39	Elias LOUAHLA 1 2	Michael AKBASHEV	0 - 10	1:11	IPO
A-48	Elias LOUAHLA 1 3	Owen MACUMBER	0 - 10	0:42	WIP
A-59	Michael AKBASHEV 2 3	Owen MACUMBER	10 - 0	0:50	IPO

## Competitors/Compétiteurs B

#	Name/Nom	Grade	Club	4	5	6	W/G	Pts	Pos
4	Pierce JING	Brown	Steveston Judo Club	XX			0	0	3
5	Amr ABD ELREHIM	Brown	Sheffield Judo Club	10	XX	10	2	20	1
6	Shion CROOK	Brown	Hiro's Judo Club	10		XX	1	10	2

## Pool B

Match	White/Blanc	Blue/Bleu	Res/Rés	Tim/Tmp	Code
A-40	Pierce JING 4 5	Amr ABD ELREHIM	0 - 10	0:56	HAN
A-49	Pierce JING 4 6	Shion CROOK	0 - 10	1:01	IPO
A-60	Amr ABD ELREHIM 5 6	Shion CROOK	10 - 0	0:14	IPO

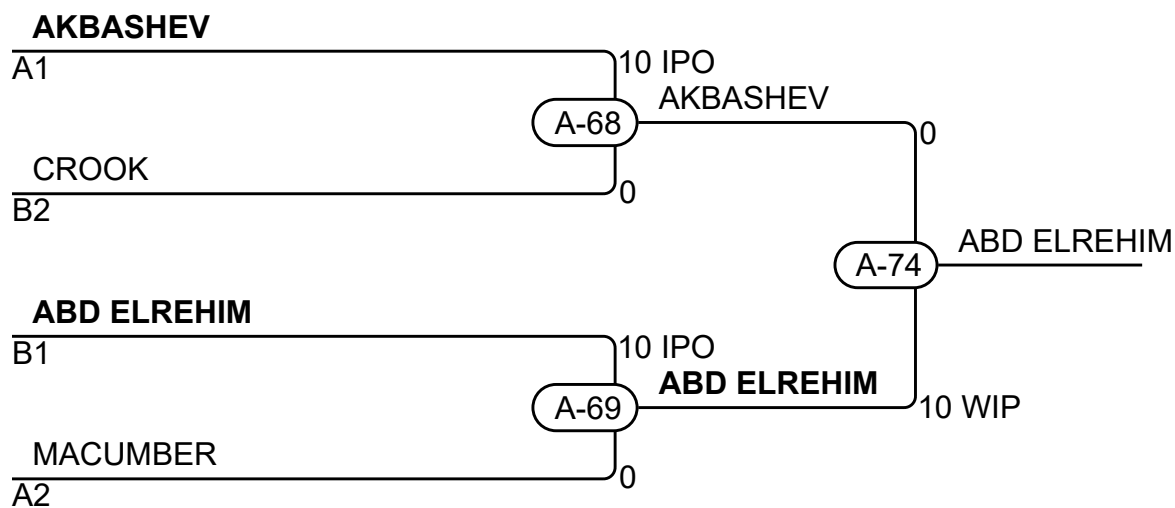

## Results/Résultats

Pos	Name/Nom
1	Amr ABD ELREHIM, Sheffield Judo Club
2	Michael AKBASHEV, West Kildonan Judo Club
3	Shion CROOK, Hiro's Judo Club
3	Owen MACUMBER, Ryudokan Judo Club

# U18 Men +90kg

## Competitors/Compétiteurs

#	Name/Nom	Grade	Club	1	2	3	4	W/G	Pts	Pos
1	Nolan ELLIOT	Blue	Kam Lake Territorial Cen	XX		10		1	10	3
2	Joseph POPOV	Brown	Toronto Judo Kai	10	XX	10		2	20	2
3	Josiah HALLETT	Green	La Ronge Judo Club			XX		0	0	4
4	John Jr MESSÉ A BESSONG	Blue	Club de judo Shidokan in	10	10	10	XX	3	30	1

## Matches/Matches

Match	White/Blanc			Blue/Bleu	Res/Rés	Tim/Tmp	Code
E-36	Nolan ELLIOT	1	2	Joseph POPOV	0 - 10	2:27	IPO
E-37	Josiah HALLETT	3	4	John Jr MESSÉ A BESSONG	0 - 10	1:27	IPO
E-52	Nolan ELLIOT	1	3	Josiah HALLETT	10 - 0	1:29	IPO
E-53	Joseph POPOV	2	4	John Jr MESSÉ A BESSONG	0 - 10	1:45	HAN
E-64	Nolan ELLIOT	1	4	John Jr MESSÉ A BESSONG	0 - 10	4:27	HAN
E-65	Joseph POPOV	2	3	Josiah HALLETT	10 - 0	1:21	WIP

## Results/Résultats

Pos	Name/Nom
1	John Jr MESSÉ A BESSONG, Club de judo Shidoka
2	Joseph POPOV, Toronto Judo Kai
3	Nolan ELLIOT, Kam Lake Territorial Centre

# U18 Women -44kg

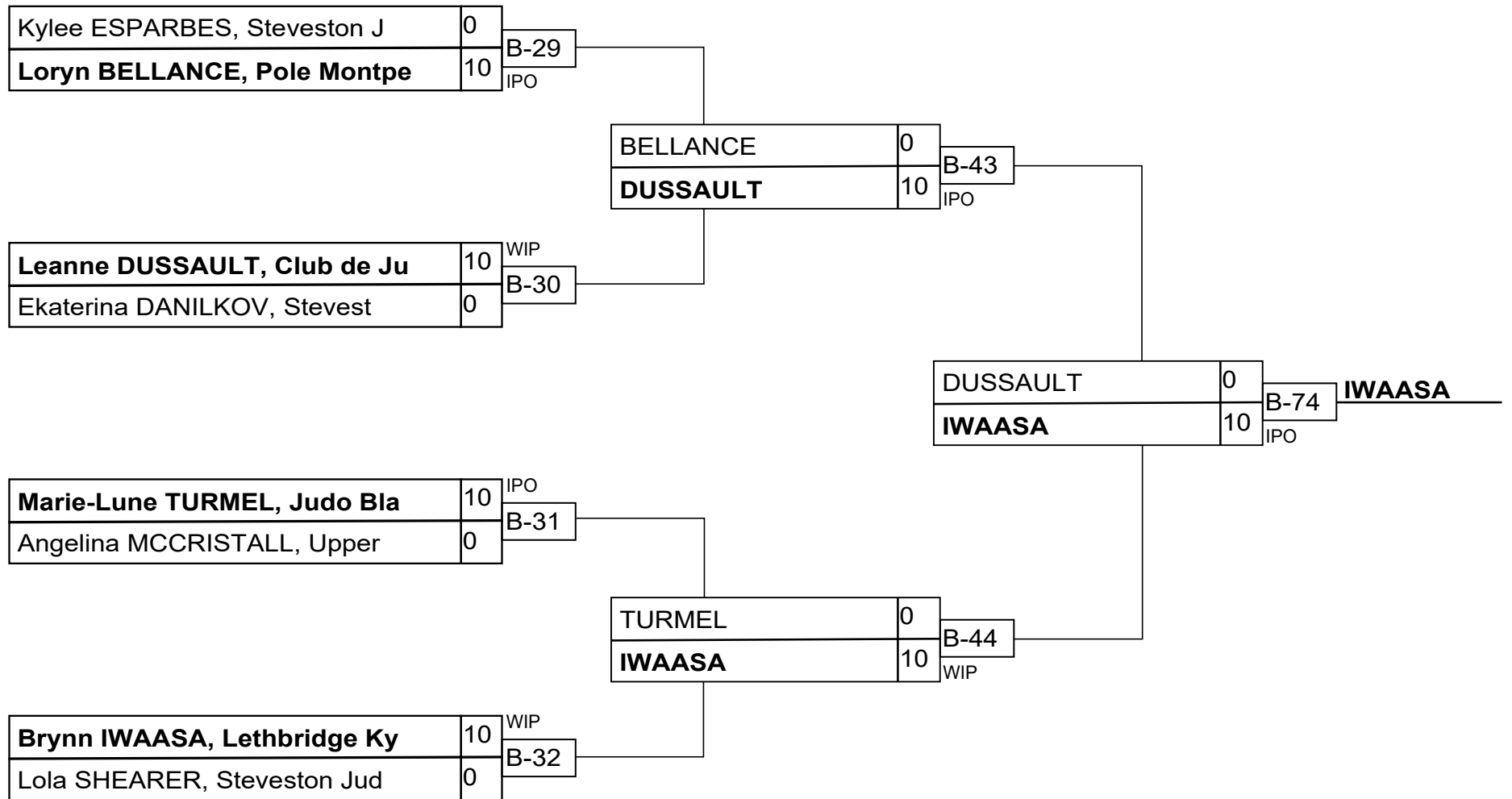

## Results/Résultats

Pos	Name/Nom
1	Brynn IWAASA, Lethbridge
2	Leanne DUSSAULT, Club de
3	Loryn BELLANCE, Pole Mon
3	Marie-Lune TURMEL, Judo

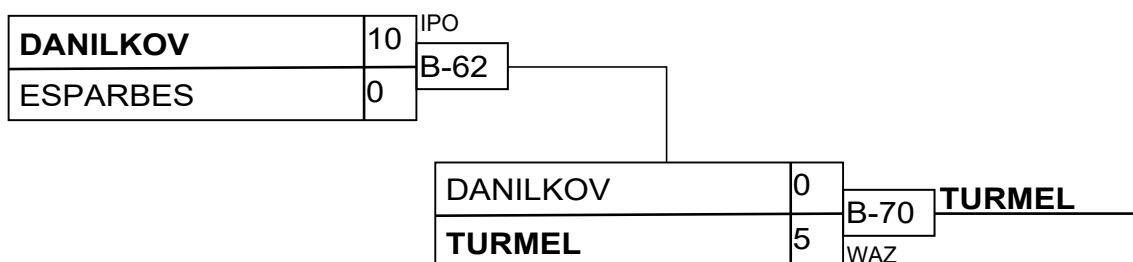
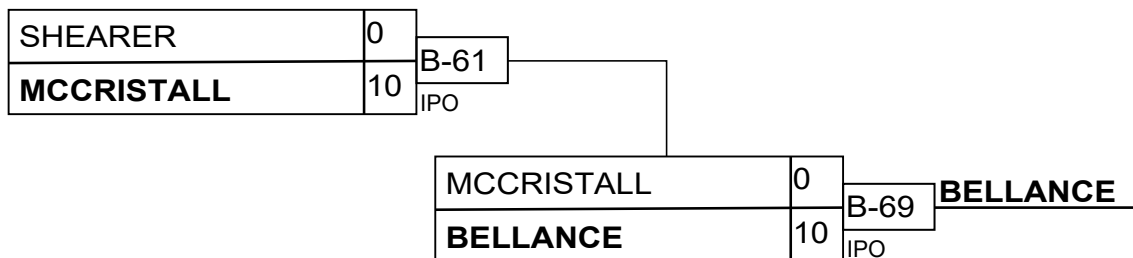



# U18 Women -52kg

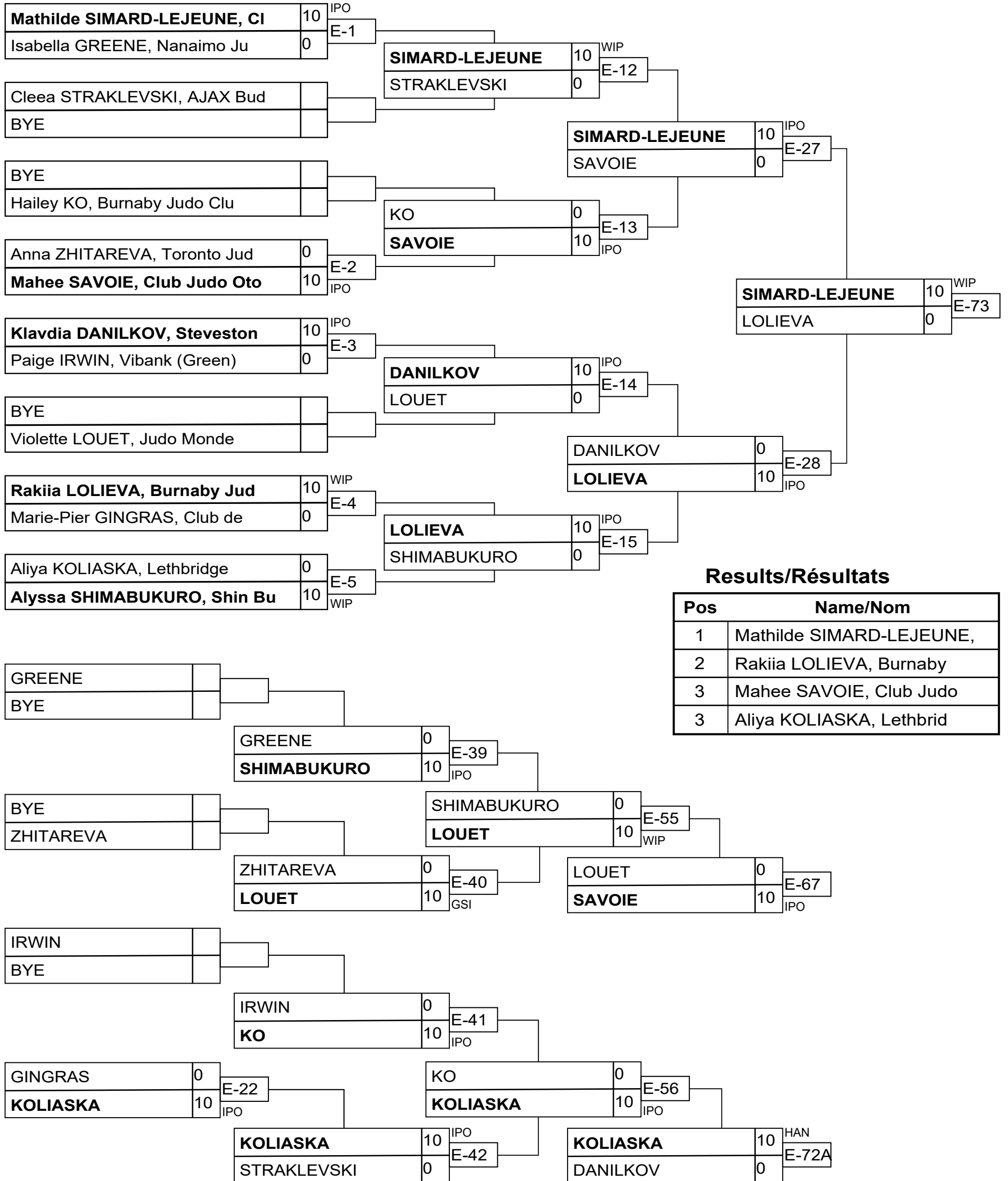

## Results/Résultats

Pos	Name/Nom
1	Mathilde SIMARD-LEJEUNE,
2	Rakiia LOLIEVA, Burnaby
3	Mahee SAVOIE, Club Judo
3	Aliya KOLIASKA, Lethbrid

# U18 Women -57kg

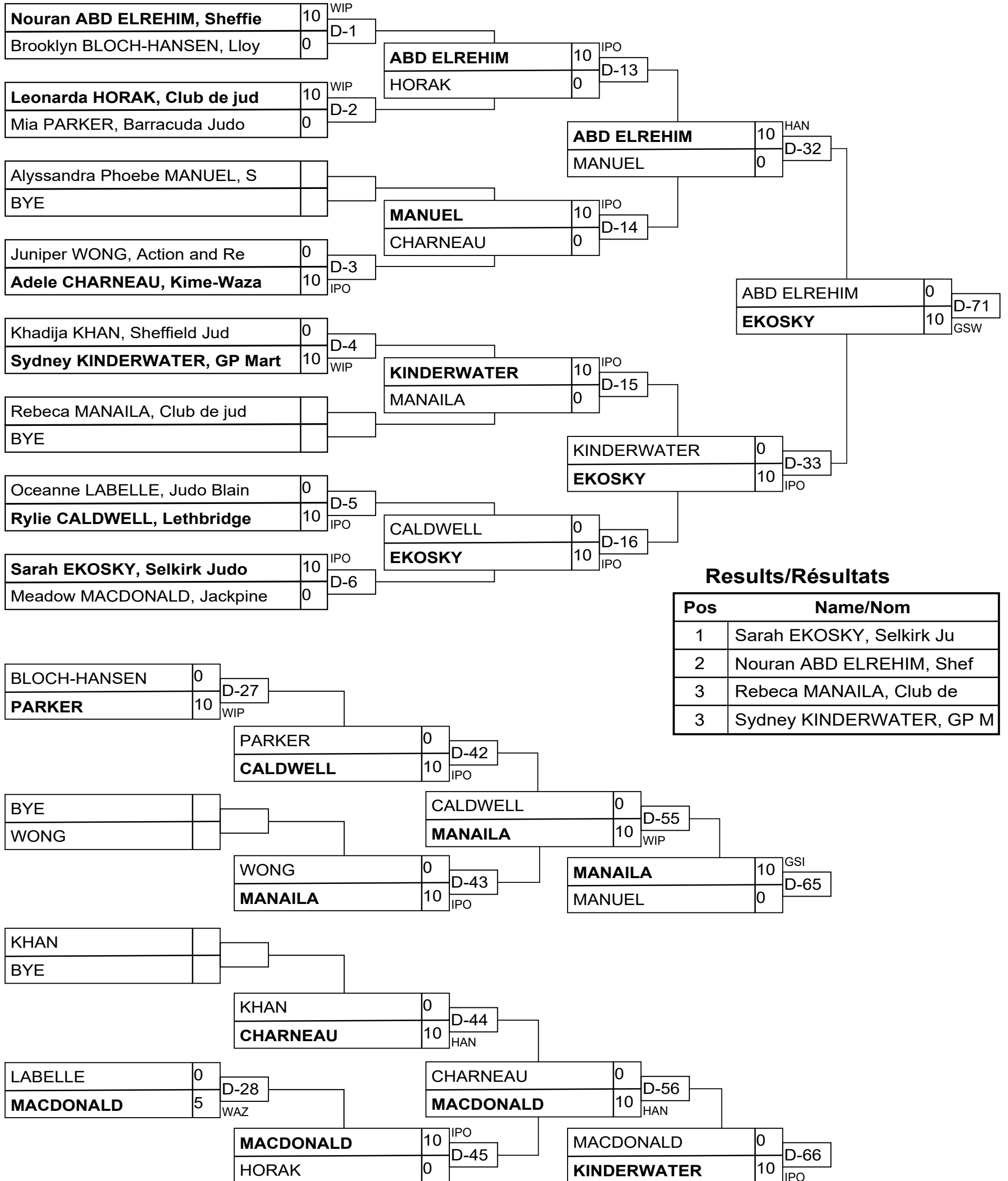

## Results/Résultats

Pos	Name/Nom
1	Sarah EKOSKY, Selkirk Ju
2	Nouran ABD ELREHIM, Shef
3	Rebeca MANAILA, Club de
3	Sydney KINDERWATER, GP M



# U18 Women -63kg

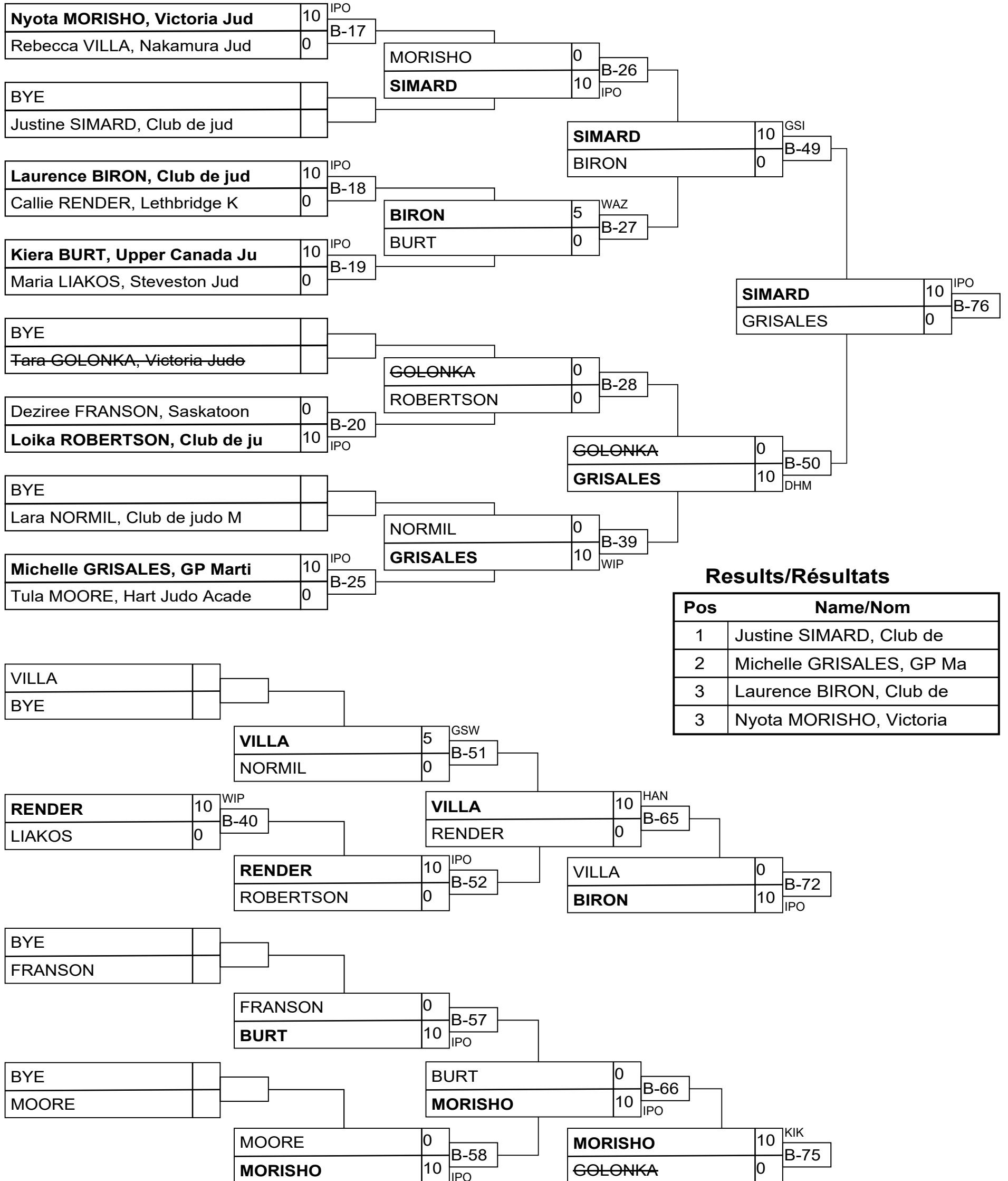

## Results/Résultats

Pos	Name/Nom
1	Justine SIMARD, Club de
2	Michelle GRISALES, GP Ma
3	Laurence BIRON, Club de
3	Nyota MORISHO, Victoria

# U18 Women -70kg

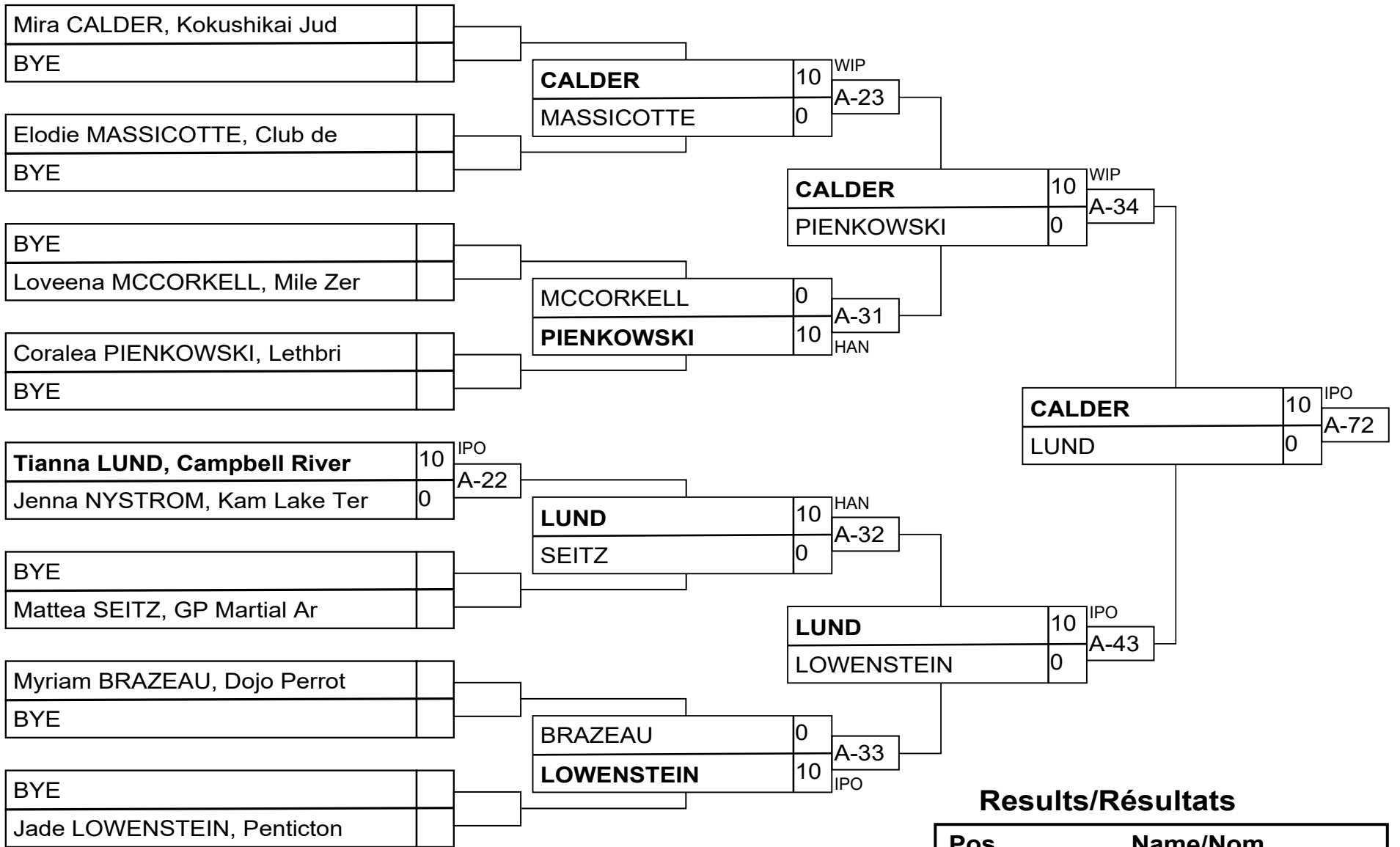

## Results/Résultats

Pos	Name/Nom
1	Mira CALDER, Kokushikai
2	Tianna LUND, Campbell Ri
3	Coralea PIENKOWSKI, Leth
3	Loveena MCCORKELL, Mile

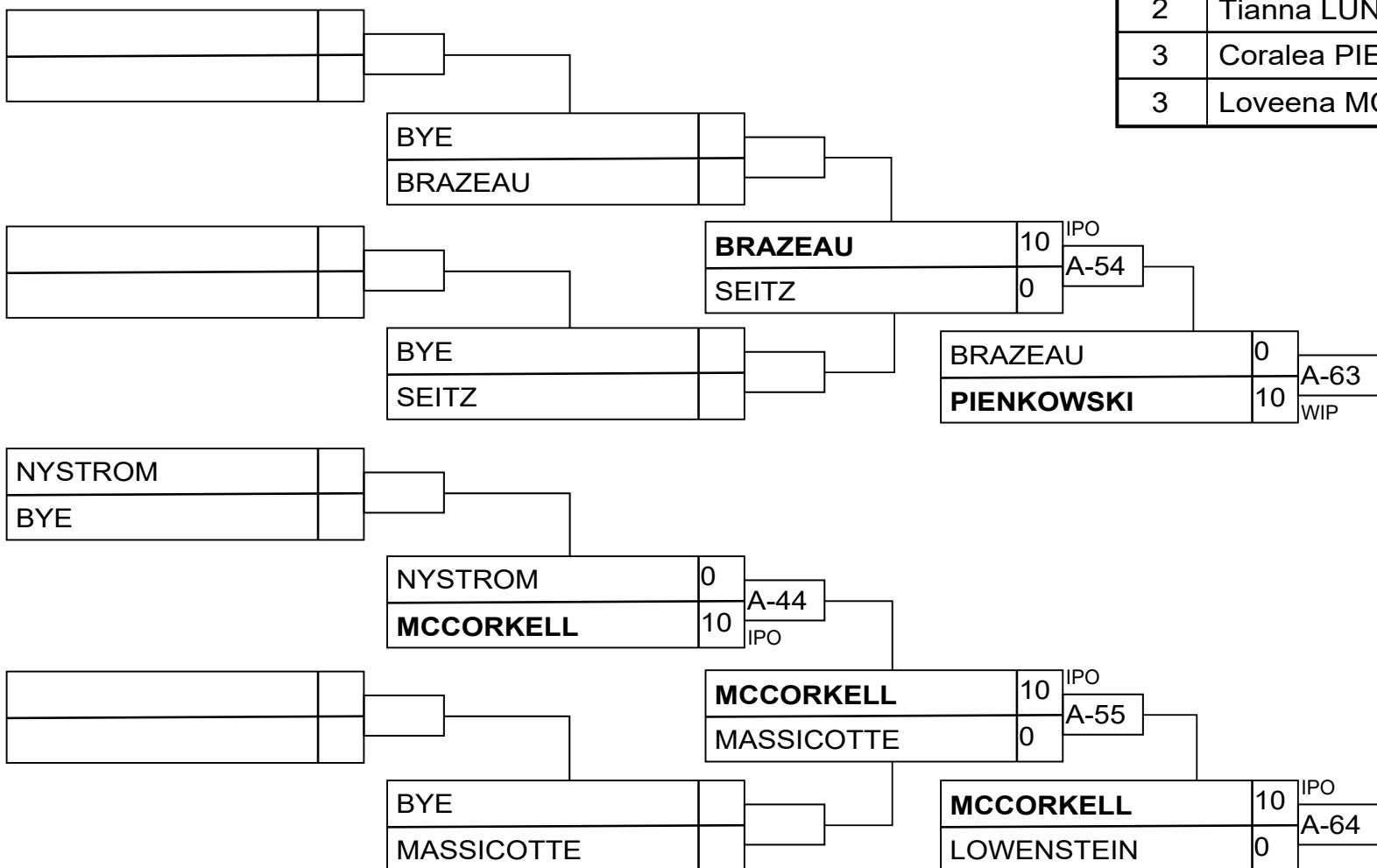

# U18 Women +70kg

## Competitors/Compétiteurs

#	Name/Nom	Grade	Club	1	2	1	2	1	2	W/G	Pts	Pos
1	Elodie LEFEBVRE	Blue	Club de Judo d'Asbestos-	XX	10	XX		XX		1	10	2
2	Jannessa KEAYS	Blue	Saskatoon Ymca Judo Club		XX	10	XX	10	XX	2	20	1

## Matches/Matches

Match	White/Blanc			Blue/Bleu	Res/Rés	Tim/Tmp	Code
D-41	<b>Elodie LEFEBVRE</b>	1	2	Jannessa KEAYS	10 - 0	1:18	IPO
D-54	<b>Jannessa KEAYS</b>	2	1	Elodie LEFEBVRE	10 - 0	3:21	WIP
D-64	Elodie LEFEBVRE	1	2	<b>Jannessa KEAYS</b>	0 - 10	3:56	WIP

## Results/Résultats

Pos	Name/Nom
1	Jannessa KEAYS, Saskatoon Ymca Judo Club
2	Elodie LEFEBVRE, Club de Judo d'Asbestos-Danv

# U21 Men -100kg

## Competitors/Compétiteurs

#	Name/Nom	Grade	Club	1	2	1	2	1	2	W/G	Pts	Pos
1	Simon POPOV	Brown	Toronto Judo Kai	XX	10	XX	10	XX		2	20	1
2	Owen MILLER	Brown	Port Colborne Judo Club		XX		XX		XX	0	0	2

## Matches/Matches

Match	White/Blanc			Blue/Bleu	Res/Rés	Tim/Tmp	Code
B-21	<b>Simon POPOV</b>	1	2	Owen MILLER	10 - 0	1:15	IPO
B-28	Owen MILLER	2	1	<b>Simon POPOV</b>	0 - 10	0:34	IPO
B-34	Simon POPOV	1	2	Owen MILLER			

## Results/Résultats

Pos	Name/Nom
1	Simon POPOV, Toronto Judo Kai

# U21 Men -60kg

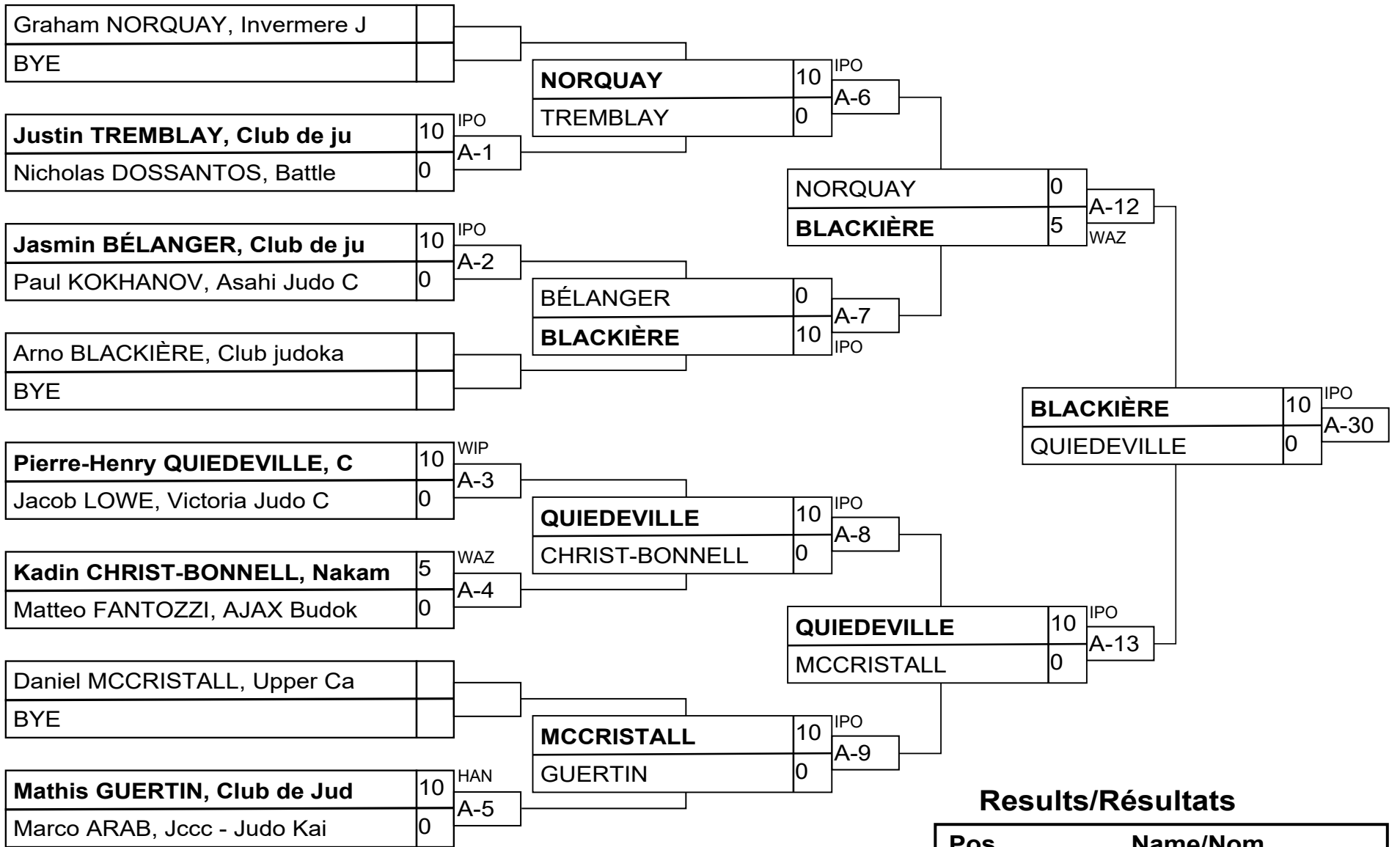

## Results/Résultats

Pos	Name/Nom
1	Arno BLACKIÈRE, Club jud
2	Pierre-Henry QUIEDEVILLE
3	Graham NORQUAY, Invermer
3	Daniel MCCRISTALL, Upper

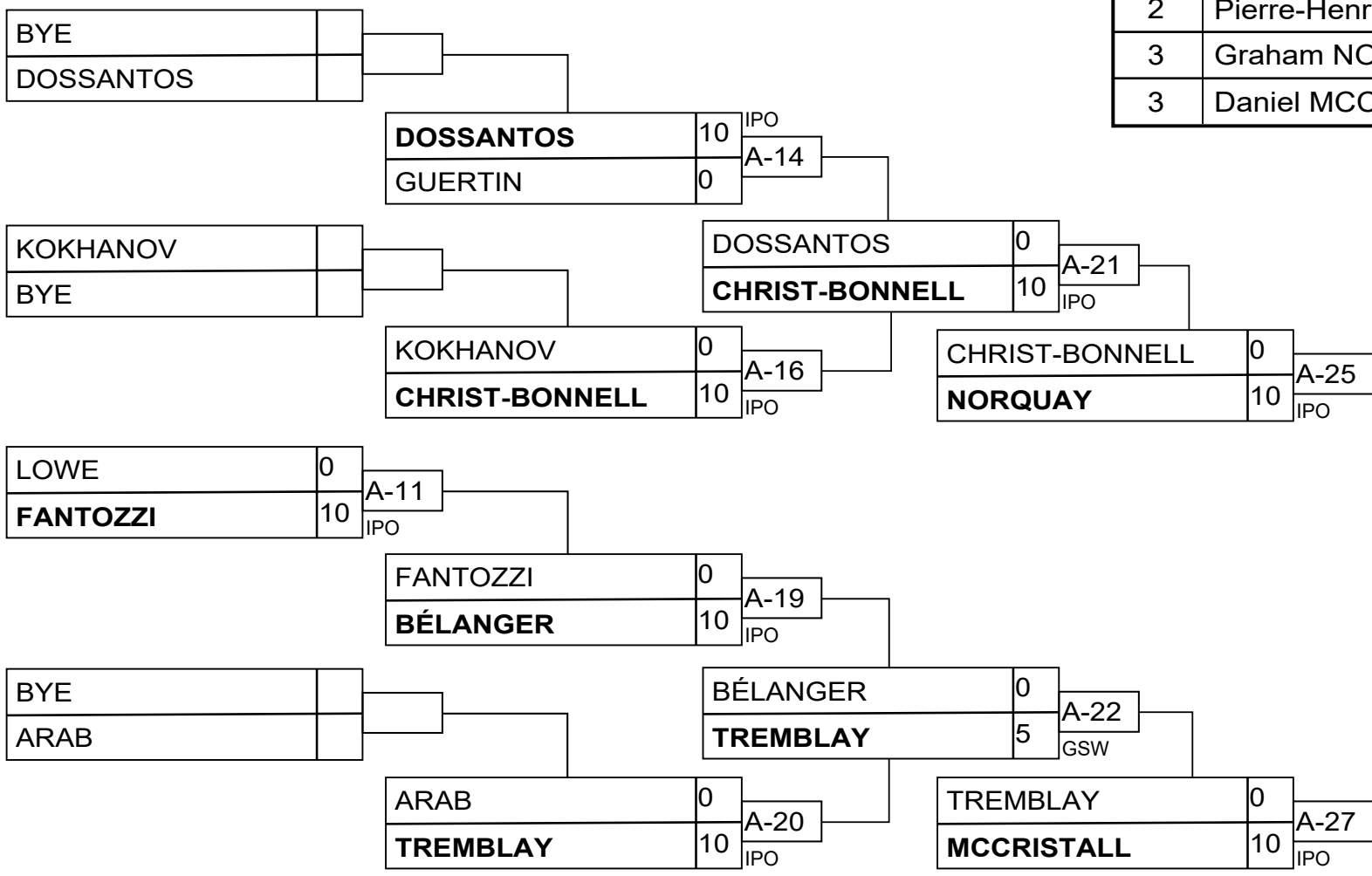

# U21 Men -66kg

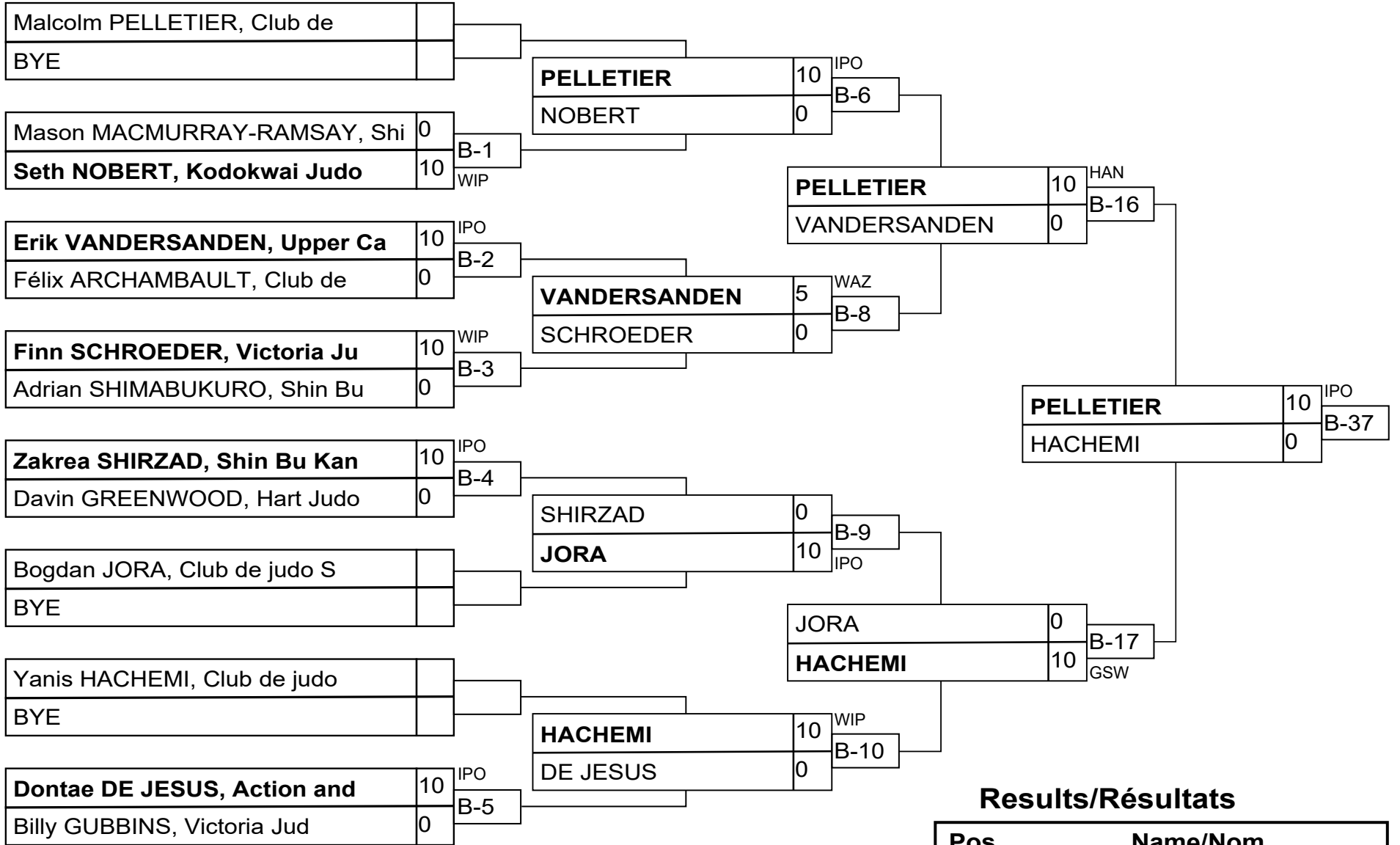

## Results/Résultats

Pos	Name/Nom
1	Malcolm PELLETIER, Club
2	Yanis HACHEMI, Club de j
3	Erik VANDERSANDEN, Upper
3	Bogdan JORA, Club de jud

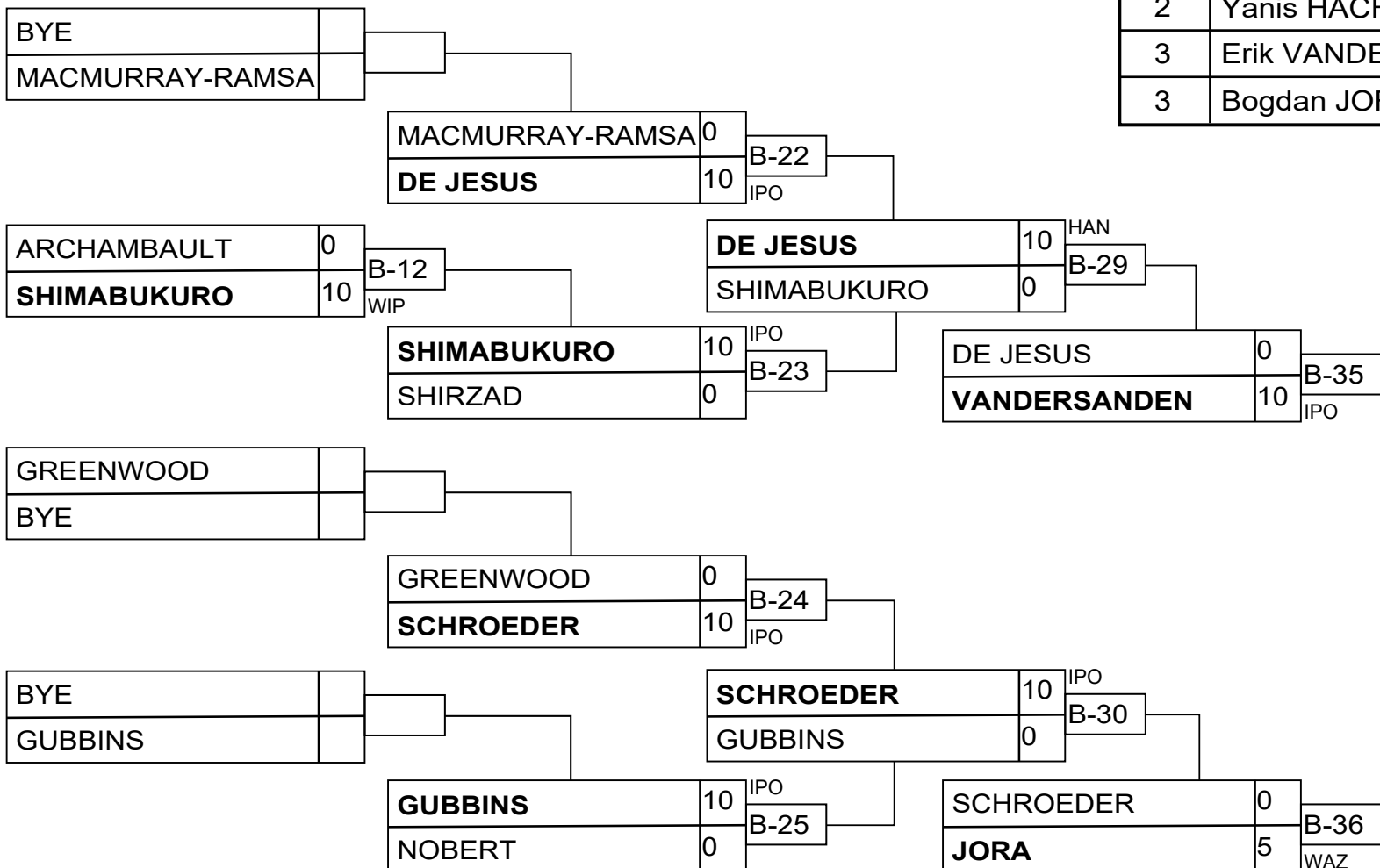

# U21 Men -73kg

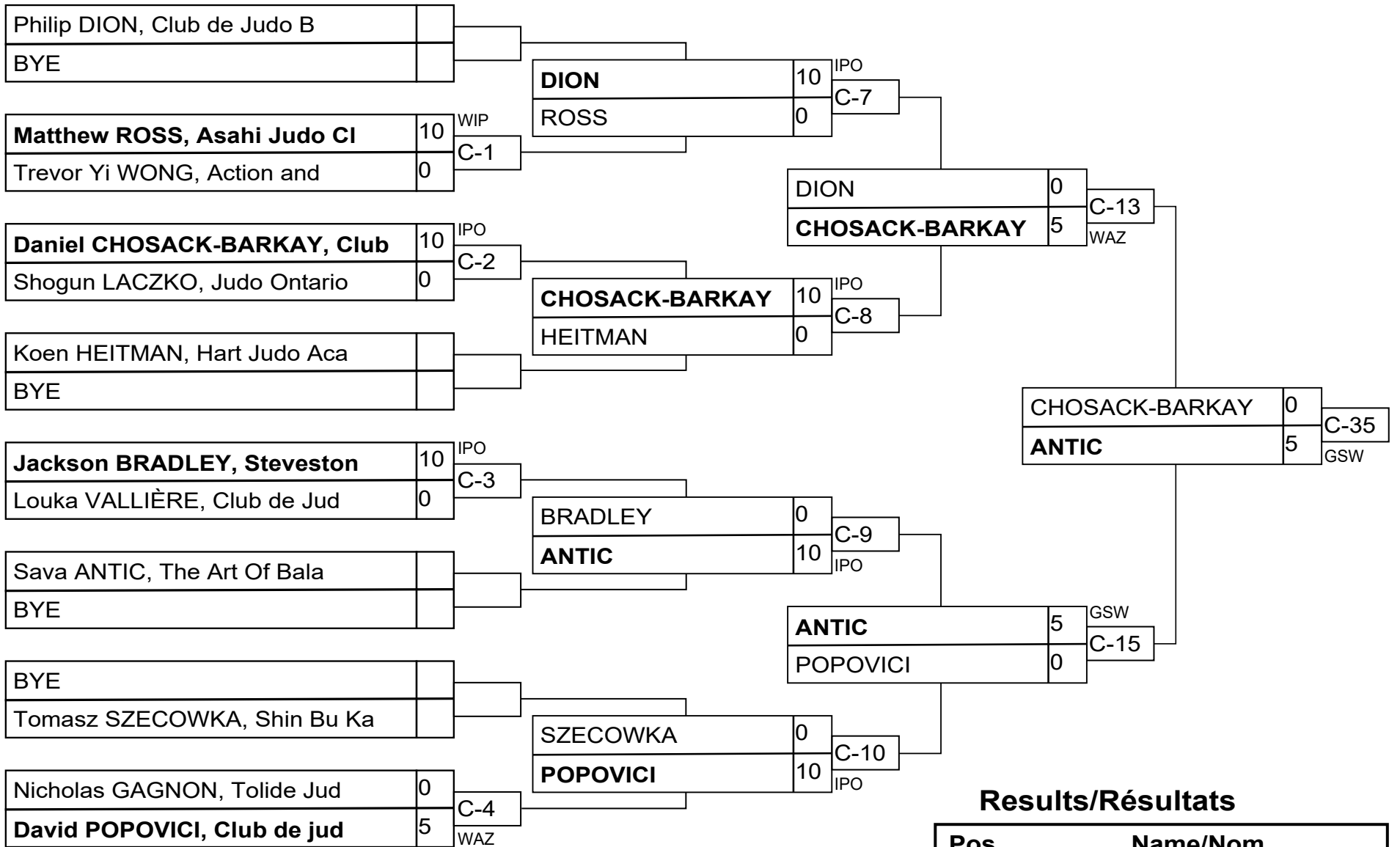

## Results/Résultats

Pos	Name/Nom
1	Sava ANTIC, The Art Of B
2	Daniel CHOSACK-BARKAY, C
3	Philip DION, Club de Jud
3	David POPOVICI, Club de

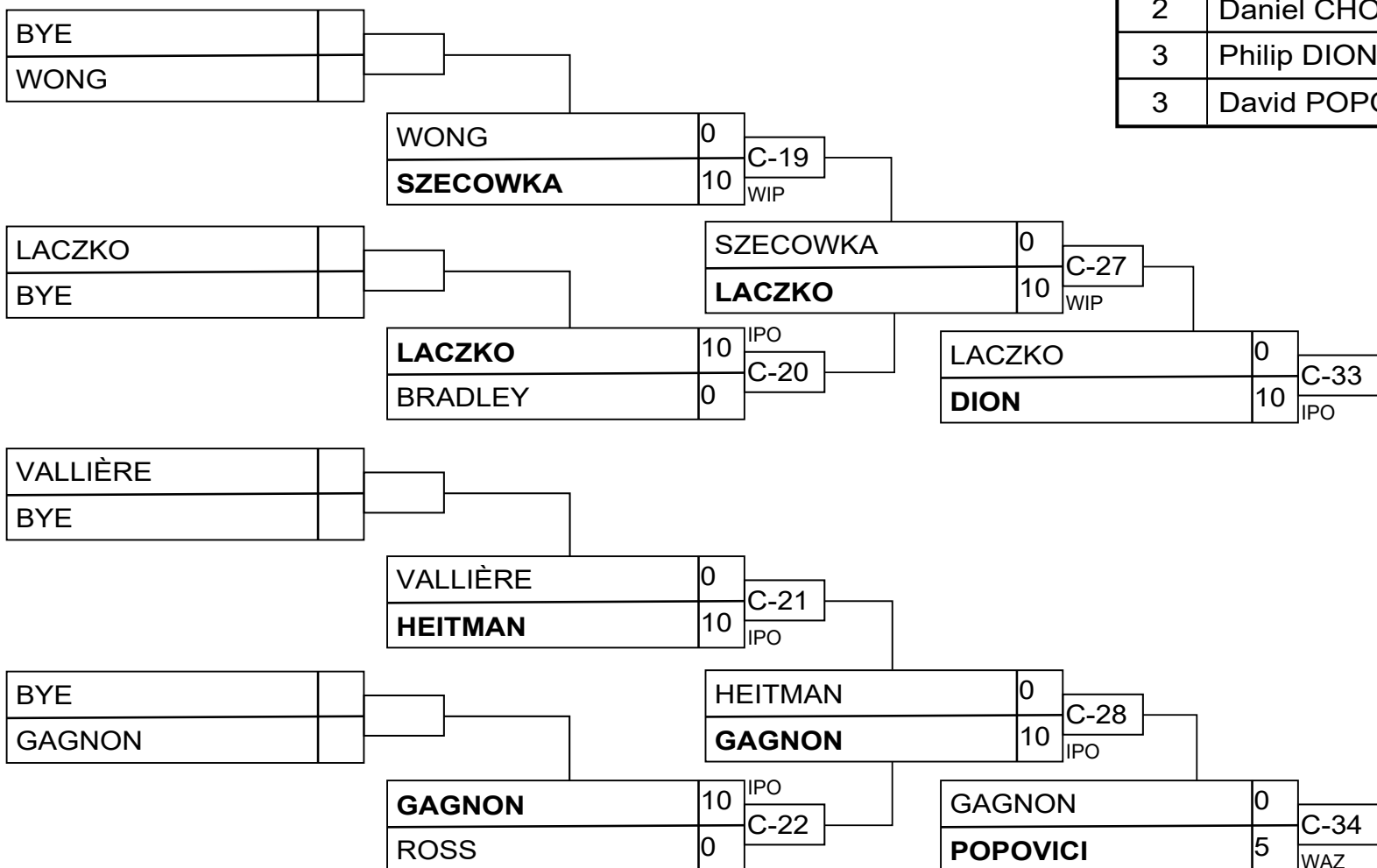

# U21 Men -81kg

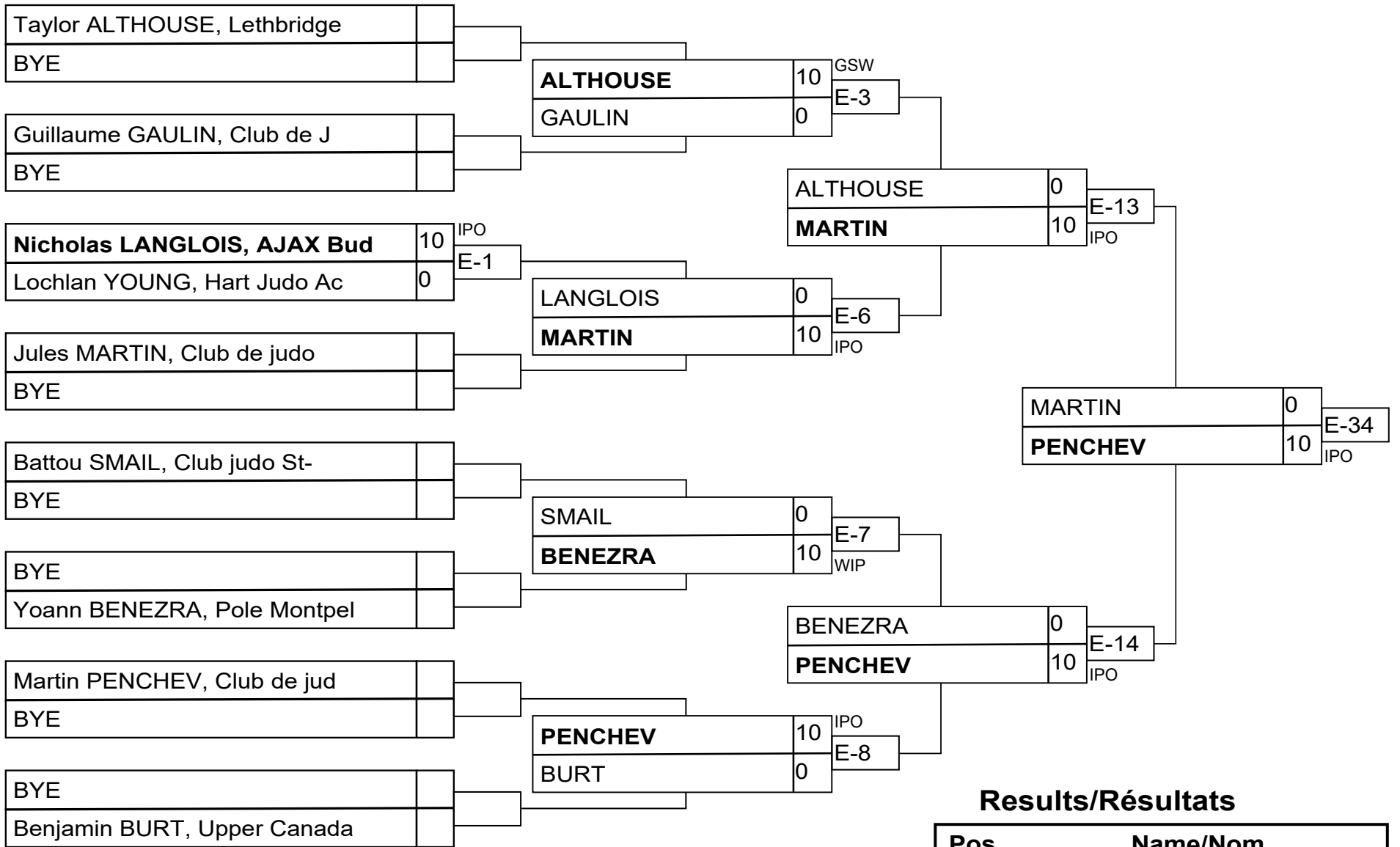

## Results/Résultats

Pos	Name/Nom
1	Martin PENCHEV, Club de
2	Jules MARTIN, Club de ju
3	Taylor ALTHOUSE, Lethbri
3	Yoann BENEZRA, Pole Mont

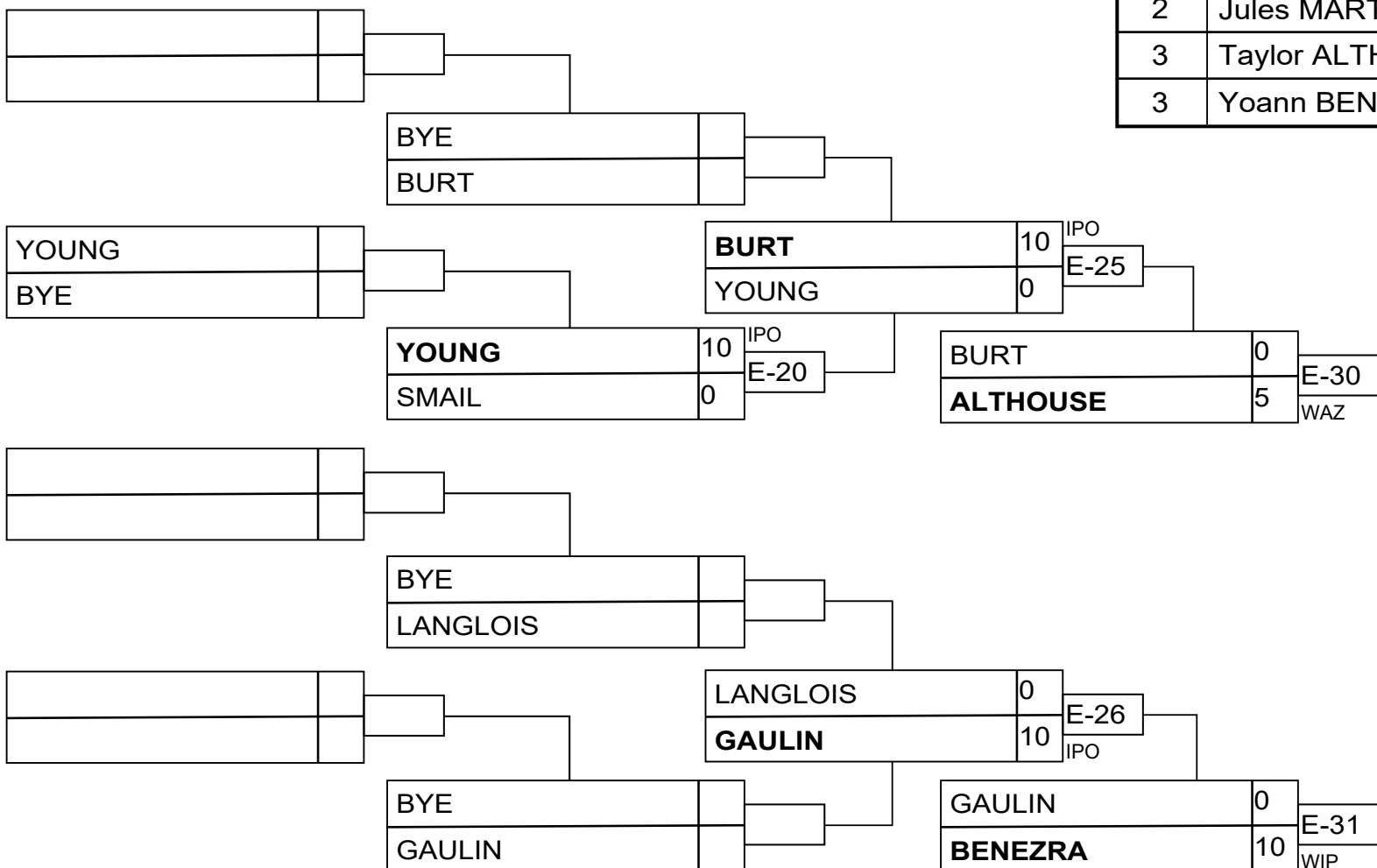



# U21 Men -90kg

## Competitors/Compétiteurs

#	Name/Nom	Grade	Club	1	2	3	4	5	W/G	Pts	Pos
1	Sasha TANASIUK	Blue	Kodokwai Judo Club	XX			10		1	10	4
2	Jackson MINNICK	Shodan	Victoria Judo Club	10	XX	5	10		3	25	2
3	Boris BERGERON	Shodan	Club de judo Shidokan in	10		XX	10		2	20	3
4	Nicolas LEVESQUE LESSARD	Brown	Club de judo Shidokan in				XX		0	0	5
5	Benjamin KENDRICK	Nidan	Takahashi Dojo	10	10	5	10	XX	4	35	1

## Matches/Matches

Match	White/Blanc			Blue/Bleu	Res/Rés	Tim/Tmp	Code
C-5	Nicolas LEVESQUE LESSARD	4	5	<b>Benjamin KENDRICK</b>	0 - 10	1:02	IPO
C-6	Sasha TANASIUK	1	2	<b>Jackson MINNICK</b>	0 - 10	0:23	IPO
C-11	<b>Boris BERGERON</b>	3	4	Nicolas LEVESQUE LESSARD	10 - 0	0:20	IPO
C-12	Sasha TANASIUK	1	5	<b>Benjamin KENDRICK</b>	0 - 10	0:58	IPO
C-16	<b>Jackson MINNICK</b>	2	3	Boris BERGERON	5 - 0	4:00	WAZ
C-17	<b>Sasha TANASIUK</b>	1	4	Nicolas LEVESQUE LESSARD	10 - 0	1:13	IPO
C-23	Boris BERGERON	3	5	<b>Benjamin KENDRICK</b>	0 - 5	4:00	WAZ
C-24	<b>Jackson MINNICK</b>	2	4	Nicolas LEVESQUE LESSARD	10 - 0	2:37	IPO
C-29	Sasha TANASIUK	1	3	<b>Boris BERGERON</b>	0 - 10	0:59	WIP
C-30	Jackson MINNICK	2	5	<b>Benjamin KENDRICK</b>	0 - 10	2:23	HAN

## Results/Résultats

Pos	Name/Nom
1	Benjamin KENDRICK, Takahashi Dojo
2	Jackson MINNICK, Victoria Judo Club
3	Boris BERGERON, Club de judo Shidokan inc.
4	Sasha TANASIUK, Kodokwai Judo Club

# U21 Men +100kg

## Competitors/Compétiteurs

#	Name/Nom	Grade	Club	1	W/G	Pts	Pos
1	Wilson ELLIOT	Brown	Kam Lake Territorial Cen	XX	0	0	1

## Matches/Matches

Match	White/Blanc	Blue/Bleu	Res/Rés	Tim/Tmp	Code
-------	-------------	-----------	---------	---------	------

## Results/Résultats

Pos	Name/Nom

# U21 Women -52kg

## Competitors/Compétiteurs A

#	Name/Nom	Grade	Club	1	2	3	W/G	Pts	Pos
1	Mellie DECONCHY	Shodan	Pole Montpellier	XX	10	10	2	20	1
2	Amélie GRENIER	Shodan	Judo Ju Shin Kan Laterri		XX	10	1	10	2
3	Launa HINTON	Shodan	Abbotsford Judo Club			XX	0	0	3

## Pool A

Match	White/Blanc	Blue/Bleu	Res/Rés	Tim/Tmp	Code
A-17	Mellie DECONCHY 1 2	Amélie GRENIER	10 - 0	2:32	WIP
A-23	Mellie DECONCHY 1 3	Launa HINTON	10 - 0	3:29	WIP
A-28	Amélie GRENIER 2 3	Launa HINTON	10 - 0	2:28	IPO

## Competitors/Compétiteurs B

#	Name/Nom	Grade	Club	4	5	6	W/G	Pts	Pos
4	Léa ROY	Shodan	Club de Judo d'Asbestos-	XX			0	0	3
5	Emilija Ema TESANOVIC	Shodan	Ishi Yama Institute Of J	10	XX	10	2	20	1
6	Sarah MALOUM	Shodan	Club de judo Métropolitaine	10		XX	1	10	2

## Pool B

Match	White/Blanc	Blue/Bleu	Res/Rés	Tim/Tmp	Code
A-18	Léa ROY 4 5	Emilija Ema TESANOVIC	0 - 10	1:50	IPO
A-24	Léa ROY 4 6	Sarah MALOUM	0 - 10	1:21	IPO
A-29	Emilija Ema TESANOVIC 5 6	Sarah MALOUM	10 - 0	2:35	IPO

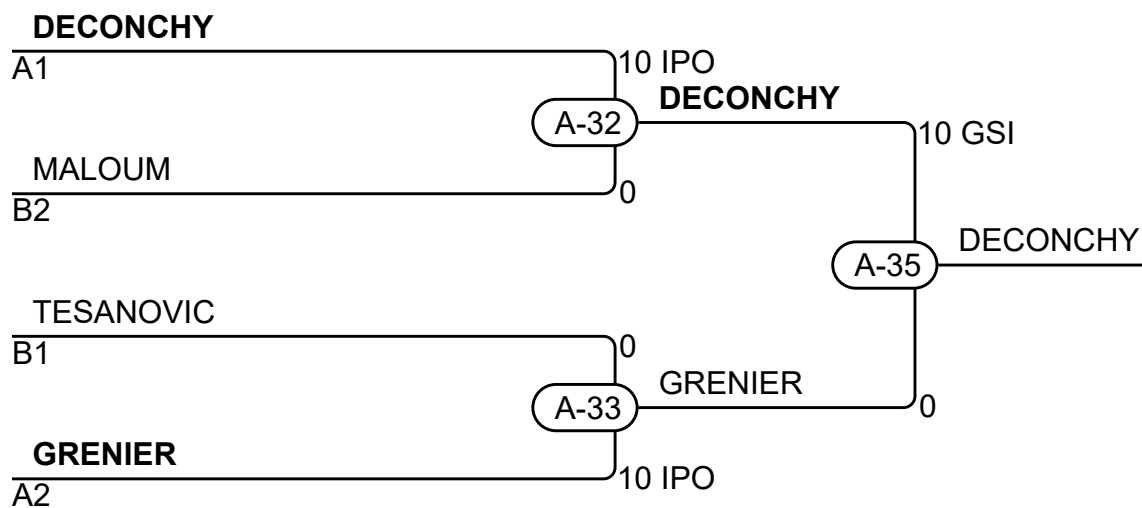

## Results/Résultats

Pos	Name/Nom
1	Mellie DECONCHY, Pole Montpellier
2	Amélie GRENIER, Judo Ju Shin Kan Laterrière
3	Sarah MALOUM, Club de judo Métropolitain inc
3	Emilija Ema TESANOVIC, Ishi Yama Institute Of

# U21 Women -57kg

## Competitors/Compétiteurs

#	Name/Nom	Grade	Club	1	2	3	4	5	W/G	Pts	Pos
1	Kelley POLOWY	Blue	Kodokwai Judo Club	XX		10			1	10	4
2	Kiera WESTLAKE	Shodan	Lethbridge Kyodokan Judo	10	XX	10	10	10	4	40	1
3	Sienna MCCORKELL	Blue	Mile Zero Judo Club			XX			0	0	5
4	Caleigh KURAMOTO	Shodan	Steveston Judo Club	10		10	XX	10	3	30	2
5	Seleena BRESSON-ADAMS	Brown	Lethbridge Kyodokan Judo	10		10		XX	2	20	3

## Matches/Matches

Match	White/Blanc			Blue/Bleu	Res/Rés	Tim/Tmp	Code
B-7	<b>Caleigh KURAMOTO</b>	4	5	Seleena BRESSON-ADAMS	10 - 0	2:04	HAN
B-11	Kelley POLOWY	1	2	<b>Kiera WESTLAKE</b>	0 - 10	1:35	IPO
B-13	Sienna MCCORKELL	3	4	<b>Caleigh KURAMOTO</b>	0 - 10	0:54	IPO
B-15	Kelley POLOWY	1	5	<b>Seleena BRESSON-ADAMS</b>	0 - 10	2:35	IPO
B-18	<b>Kiera WESTLAKE</b>	2	3	Sienna MCCORKELL	10 - 0	0:48	IPO
B-20	Kelley POLOWY	1	4	<b>Caleigh KURAMOTO</b>	0 - 10	1:44	IPO
B-26	Sienna MCCORKELL	3	5	<b>Seleena BRESSON-ADAMS</b>	0 - 10	1:36	IPO
B-27	<b>Kiera WESTLAKE</b>	2	4	Caleigh KURAMOTO	10 - 0	0:17	IPO
B-31	<b>Kelley POLOWY</b>	1	3	Sienna MCCORKELL	10 - 0	0:48	IPO
B-32	<b>Kiera WESTLAKE</b>	2	5	Seleena BRESSON-ADAMS	10 - 0	0:32	IPO

## Results/Résultats

Pos	Name/Nom
1	Kiera WESTLAKE, Lethbridge Kyodokan Judo Club
2	Caleigh KURAMOTO, Steveston Judo Club
3	Seleena BRESSON-ADAMS, Lethbridge Kyodokan Ju
4	Kelley POLOWY, Kodokwai Judo Club

# U21 Women -63kg

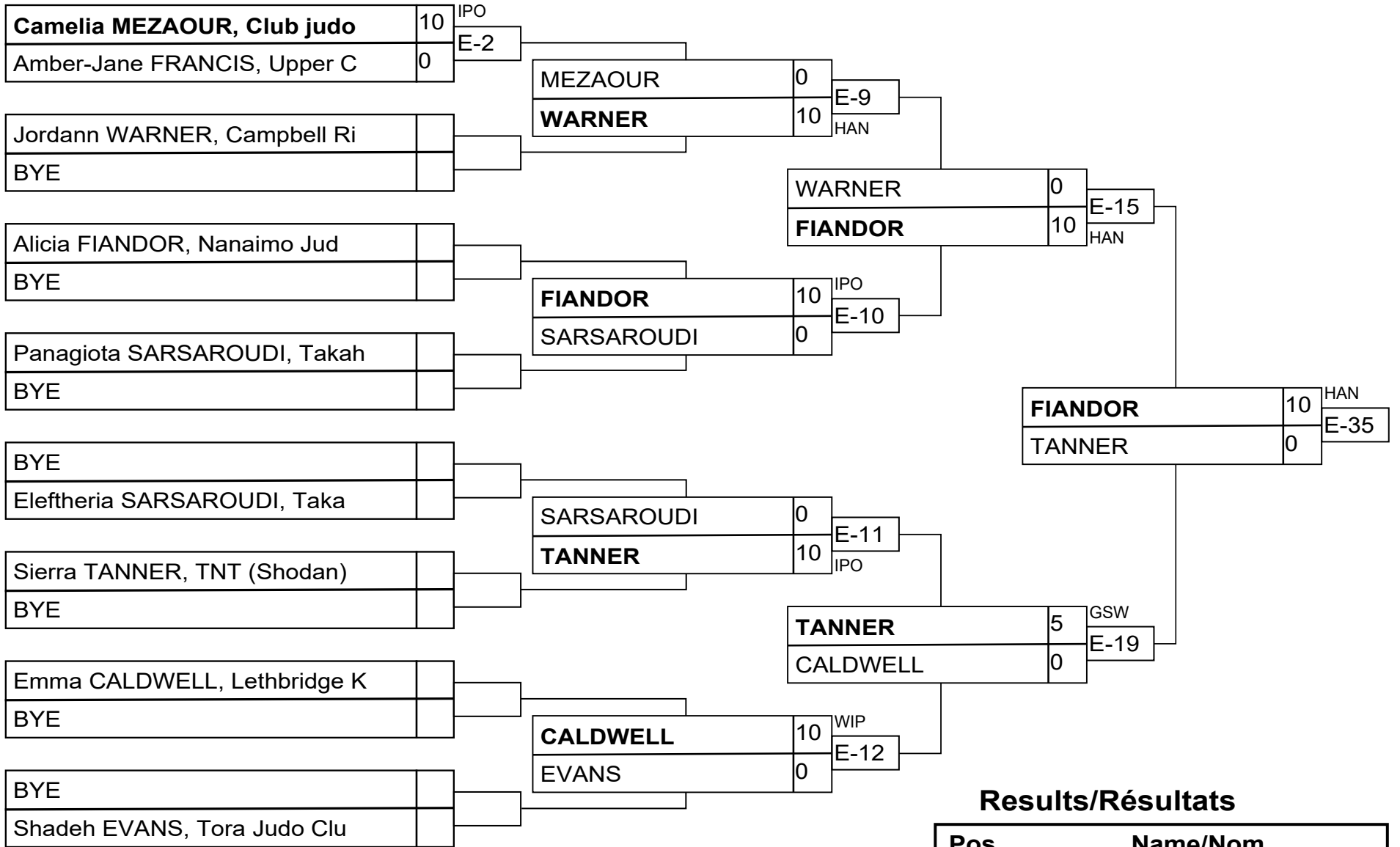

## Results/Résultats

Pos	Name/Nom
1	Alicia FIANDOR, Nanaimo
2	Sierra TANNER, TNT (Shodan)
3	Jordann WARNER, Campbell
3	Camelia MEZAOUR, Club ju

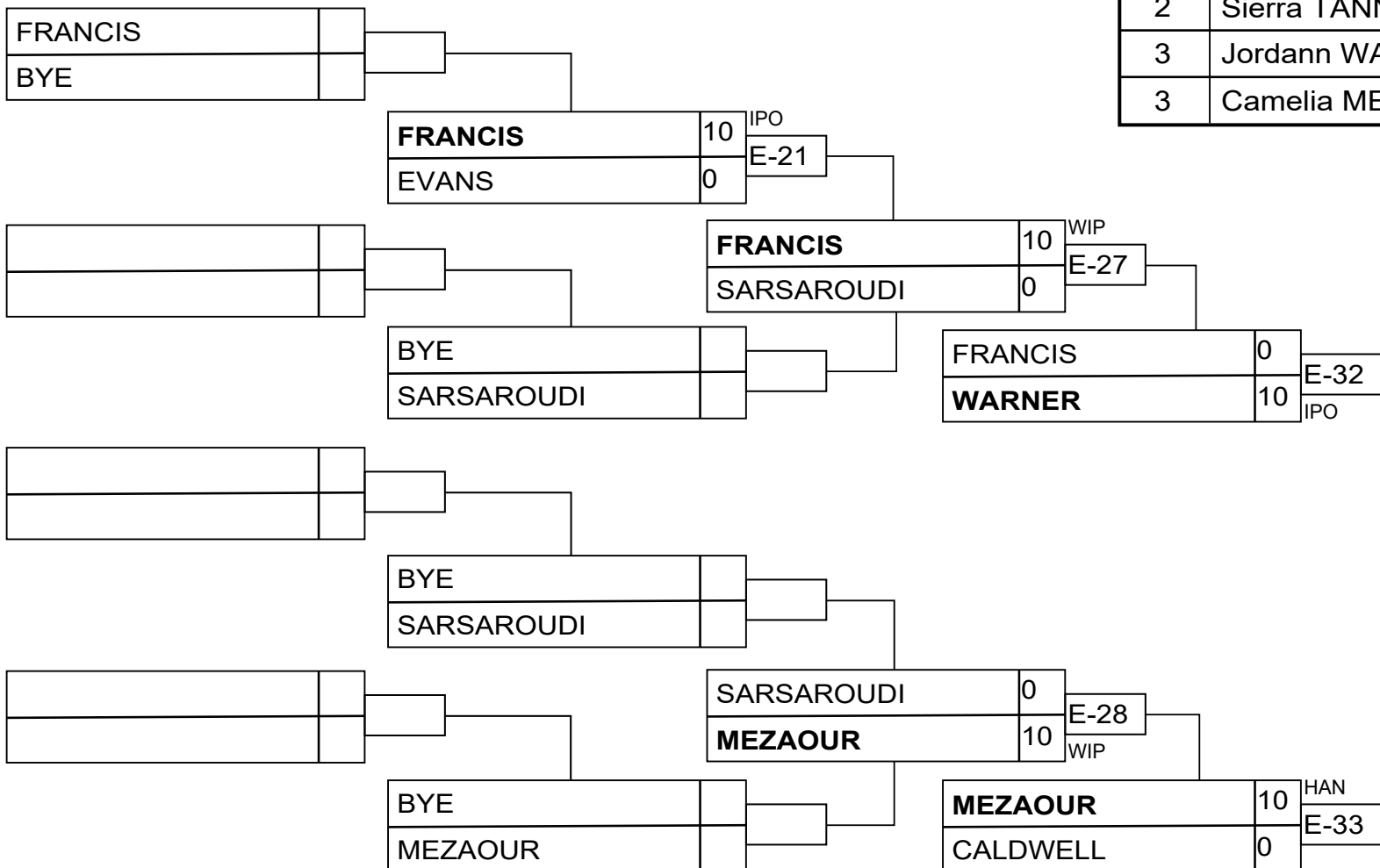

# U21 Women -70kg

## Competitors/Compétiteurs

#	Name/Nom	Grade	Club	1	2	3	W/G	Pts	Pos
1	Ariana SCHAFFEL	Blue	Lethbridge Kyodokan Judo	XX			0	0	3
2	Alexandria LEFORT	Brown	Sheffield Judo Club	10	XX	10	2	20	1
3	Brae BOOTH	Shodan	Creston Judo Club	10		XX	1	10	2

## Matches/Matches

Match	White/Blanc			Blue/Bleu	Res/Rés	Tim/Tmp	Code
C-14	Ariana SCHAFFEL	1	2	<b>Alexandria LEFORT</b>	0 - 10	0:10	IPO
C-25	Ariana SCHAFFEL	1	3	<b>Brae BOOTH</b>	0 - 10	0:52	IPO
C-31	<b>Alexandria LEFORT</b>	2	3	Brae BOOTH	10 - 0	2:46	IPO

## Results/Résultats

Pos	Name/Nom
1	Alexandria LEFORT, Sheffield Judo Club
2	Brae BOOTH, Creston Judo Club

# U21 Women -78kg

## Competitors/Compétiteurs

#	Name/Nom	Grade	Club	1	2	1	2	1	2	W/G	Pts	Pos
1	Josie-Anne SYNOTT	Shodan	Académie de Judo de Sept	XX	10	XX	10	XX		2	20	1
2	Annabelle DARLOW	Shodan	Lethbridge Kyodokan Judo		XX		XX		XX	0	0	2

## Matches/Matches

Match	White/Blanc			Blue/Bleu	Res/Rés	Tim/Tmp	Code
A-10	<b>Josie-Anne SYNOTT</b>	1	2	Annabelle DARLOW	10 - 0	4:00	IPO
A-15	Annabelle DARLOW	2	1	<b>Josie-Anne SYNOTT</b>	0 - 10	4:34	HAN
A-26	Josie-Anne SYNOTT	1	2	Annabelle DARLOW			

## Results/Résultats

Pos	Name/Nom
1	Josie-Anne SYNOTT, Académie de Judo de Sept-I

# U21 Women +78kg

## Competitors/Compétiteurs

#	Name/Nom	Grade	Club	1	W/G	Pts	Pos
1	Sara DESBIENS	Brown	Judo Ju Shin Kan Laterri	XX	0	0	1

## Matches/Matches

Match	White/Blanc	Blue/Bleu	Res/Rés	Tim/Tmp	Code
-------	-------------	-----------	---------	---------	------

## Results/Résultats

Pos	Name/Nom



# Veteran Men -100kg

## Competitors/Compétiteurs

#	Name/Nom	Grade	Club	1	2	3	W/G	Pts	Pos
1	Robert KINGSTON	Shodan	Kodokwai Judo Club	XX	10		1	10	2
2	Eric VELEZ	Blue	Jccc - Judo Kai		XX		0	0	3
3	Danick ROCHELEAU	Brown	Club de judo Métropolita	10	10	XX	2	20	1

## Matches/Matches

Match	White/Blanc			Blue/Bleu	Res/Rés	Tim/Tmp	Code
B-14	<b>Robert KINGSTON</b>	1	2	Eric VELEZ	10 - 0	1:06	IPO
B-19	Robert KINGSTON	1	3	<b>Danick ROCHELEAU</b>	0 - 10	0:41	IPO
B-33	Eric VELEZ	2	3	<b>Danick ROCHELEAU</b>	0 - 10	1:07	IPO

## Results/Résultats

Pos	Name/Nom
1	Danick ROCHELEAU, Club de judo Métropolitain
2	Robert KINGSTON, Kodokwai Judo Club

# Veteran Men -73kg

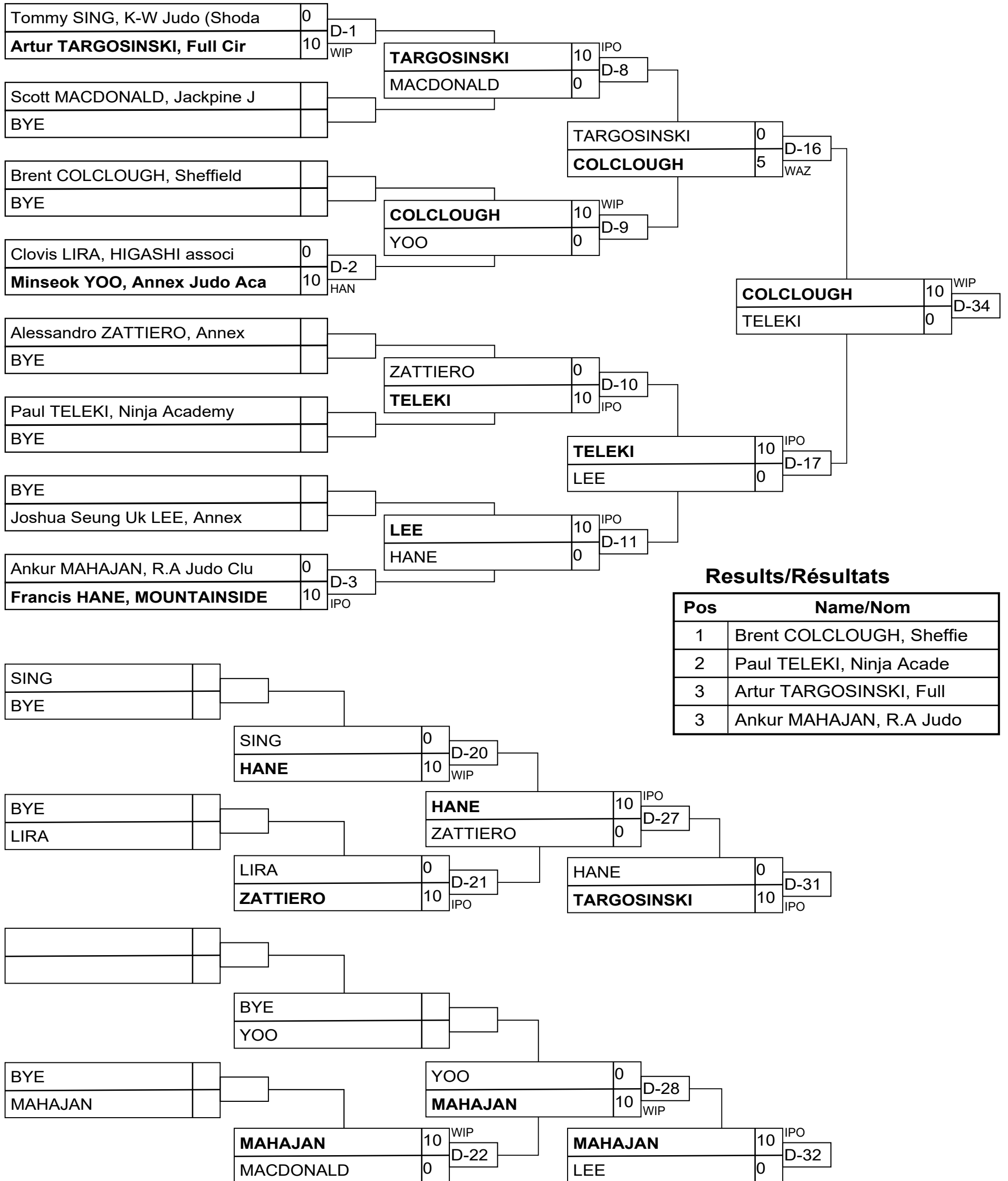

## Results/Résultats

Pos	Name/Nom
1	Brent COLCLOUGH, Sheffie
2	Paul TELEKI, Ninja Acade
3	Artur TARGOSINSKI, Full
3	Ankur MAHAJAN, R.A Judo

# Veteran Men -81kg

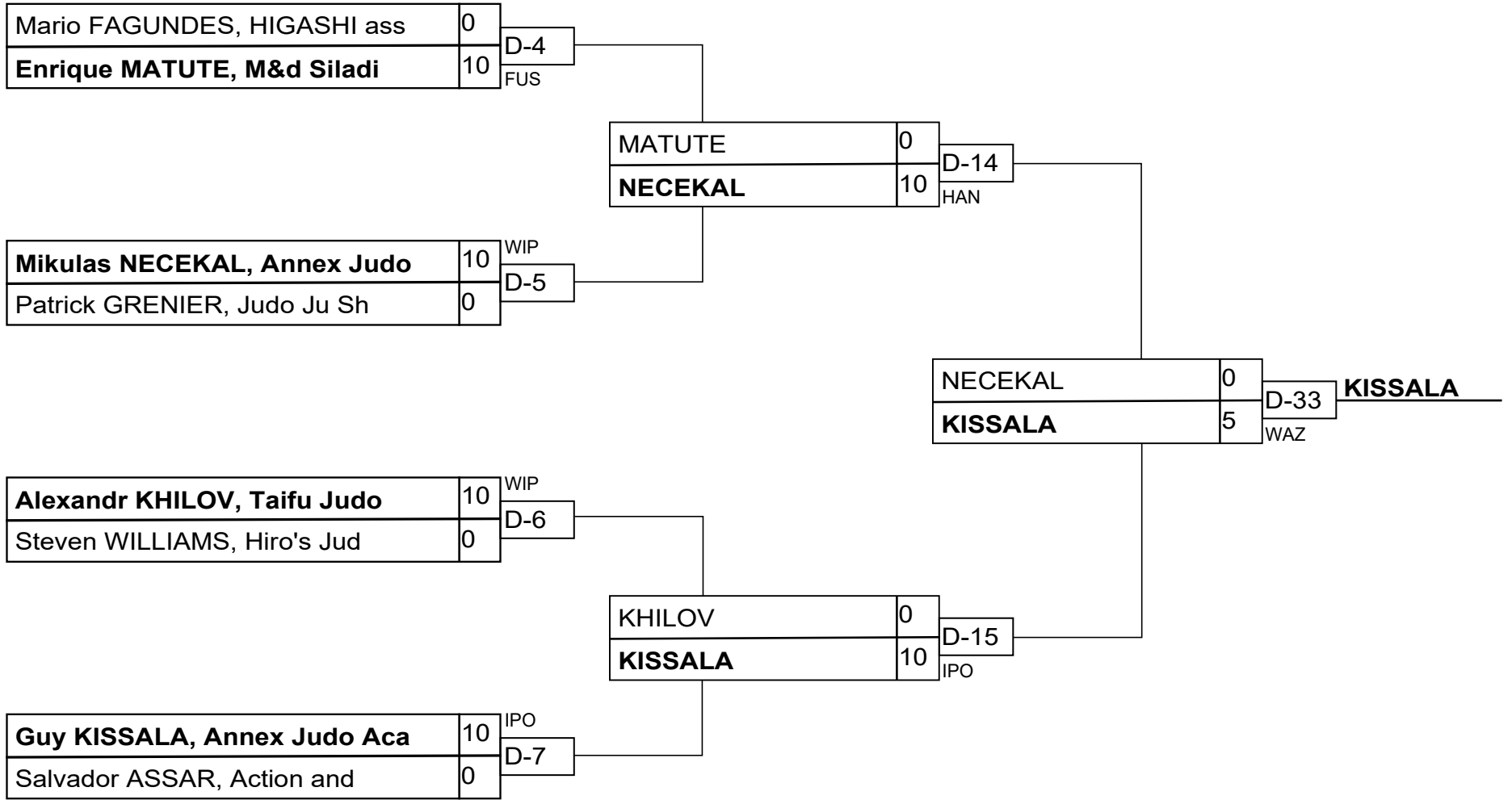

## Results/Résultats

Pos	Name/Nom
1	Guy KISSALA, Annex Judo
2	Mikulas NECEKAL, Annex J
3	Enrique MATUTE, M&d Sila
3	Mario FAGUNDES, HIGASHI

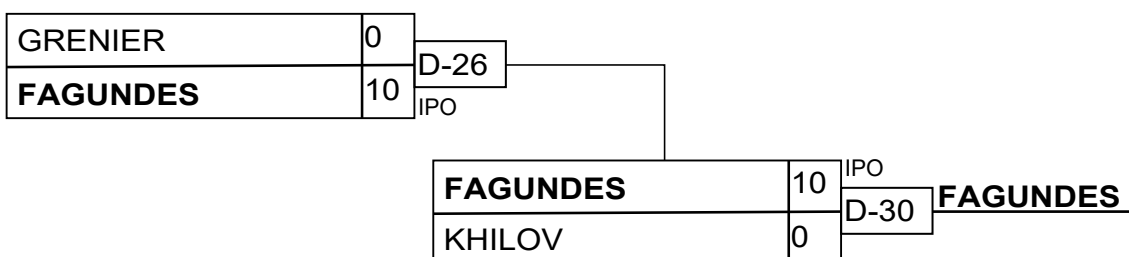
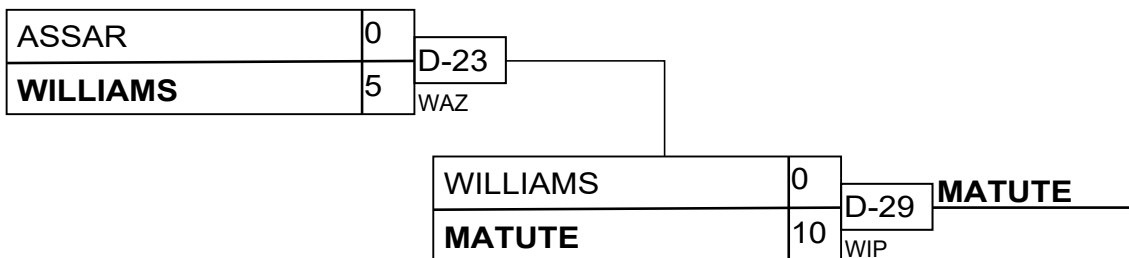

# Veteran Men -90kg

## Competitors/Compétiteurs

#	Name/Nom	Grade	Club	1	2	3	4	W/G	Pts	Pos
1	Yann ALLARD-TREMBLAY	Shodan	Jccc - Judo Kai	XX				0	0	4
2	Taras SHATKO	Brown	Annex Judo Academy	10	XX			1	10	3
3	Ugo UZOKA	Shodan	AJAX Budokan	10	10	XX		2	20	2
4	Billy-Jim CARMAN	Brown	Hayabusakan	10	10	10	XX	3	30	1

## Matches/Matches

Match	White/Blanc			Blue/Bleu	Res/Rés	Tim/Tmp	Code
E-4	Yann ALLARD-TREMBLAY	1	2	Taras SHATKO	0 - 10	1:12	IPO
E-5	Ugo UZOKA	3	4	Billy-Jim CARMAN	0 - 10	1:23	IPO
E-16	Yann ALLARD-TREMBLAY	1	3	Ugo UZOKA	0 - 10	0:45	IPO
E-17	Taras SHATKO	2	4	Billy-Jim CARMAN	0 - 10	0:24	GSI
E-22	Yann ALLARD-TREMBLAY	1	4	Billy-Jim CARMAN	0 - 10	0:00	IPO
E-24	Taras SHATKO	2	3	Ugo UZOKA	0 - 10	1:09	IPO

## Results/Résultats

Pos	Name/Nom
1	Billy-Jim CARMAN, Hayabusakan
2	Ugo UZOKA, AJAX Budokan
3	Taras SHATKO, Annex Judo Academy

# Veteran Men -90kg (TB)

## Competitors/Compétiteurs

#	Name/Nom	Grade	Club	1	2	3	W/G	Pts	Pos
1	Ugo UZOKA	Shodan	AJAX Budokan	XX	10		1	10	2
2	Taras SHATKO	Brown	Annex Judo Academy		XX		0	0	3
3	Billy-Jim CARMAN	Brown	Hayabusakan	10	10	XX	2	20	1

## Matches/Matches

Match	White/Blanc			Blue/Bleu	Res/Rés	Tim/Tmp	Code
E-27A	<b>Ugo UZOKA</b>	1	2	Taras SHATKO	10 - 0	1:09	IPO
E-30A	Ugo UZOKA	1	3	<b>Billy-Jim CARMAN</b>	0 - 10	1:23	IPO
E-36	Taras SHATKO	2	3	<b>Billy-Jim CARMAN</b>	0 - 10	0:24	IPO

## Results/Résultats

Pos	Name/Nom
1	Billy-Jim CARMAN, Hayabusakan
2	Ugo UZOKA, AJAX Budokan

# Veteran Men +100kg

## Competitors/Compétiteurs

#	Name/Nom	Grade	Club	1	2	3	4	W/G	Pts	Pos
1	Jeff ALLEN	Shodan	Huntsville Judo Club	XX	10	10	10	3	30	1
2	Pedro RODRIGUEZ	Shodan	Sheffield Judo Club		XX			0	0	4
3	Magno CAVALCANTI	Brown	HIGASHI association		10	XX		1	10	3
4	Ryan FRANCKOWIAK	Shodan	Cloverdale Judo Club		10	10	XX	2	20	2

## Matches/Matches

Match	White/Blanc			Blue/Bleu	Res/Rés	Tim/Tmp	Code
D-12	<b>Jeff ALLEN</b>	1	2	Pedro RODRIGUEZ	10 - 0	0:50	IPO
D-13	Magno CAVALCANTI	3	4	<b>Ryan FRANCKOWIAK</b>	0 - 10	1:27	HAN
D-18	<b>Jeff ALLEN</b>	1	3	Magno CAVALCANTI	10 - 0	0:00	IPO
D-19	Pedro RODRIGUEZ	2	4	<b>Ryan FRANCKOWIAK</b>	0 - 10	1:27	IPO
D-24	<b>Jeff ALLEN</b>	1	4	Ryan FRANCKOWIAK	10 - 0	0:31	IPO
D-25	Pedro RODRIGUEZ	2	3	<b>Magno CAVALCANTI</b>	0 - 10	1:02	WIP

## Results/Résultats

Pos	Name/Nom
1	Jeff ALLEN, Huntsville Judo Club
2	Ryan FRANCKOWIAK, Cloverdale Judo Club
3	Magno CAVALCANTI, HIGASHI association

# Veteran Ne Waza Men -100kg

## Competitors/Compétiteurs

#	Name/Nom	Grade	Club	1	2	1	2	1	2	W/G	Pts	Pos
1	Eric VELEZ	Blue	Jccc - Judo Kai	XX		XX		XX		0	0	2
2	Billy-Jim CARMAN	Brown	Hayabusakan	10	XX	10	XX		XX	2	20	1

## Matches/Matches

Match	White/Blanc			Blue/Bleu	Res/Rés	Tim/Tmp	Code
B-5	Eric VELEZ	1	2	<b>Billy-Jim CARMAN</b>	0 - 10	1:37	IPO
B-11	<b>Billy-Jim CARMAN</b>	2	1	Eric VELEZ	10 - 0	2:20	IPO
B-17	Eric VELEZ	1	2	Billy-Jim CARMAN			

## Results/Résultats

Pos	Name/Nom
1	Billy-Jim CARMAN, Hayabusakan

# Veteran Ne Waza Men -81kg

## Competitors/Compétiteurs A

#	Name/Nom	Grade	Club	1	2	3	W/G	Pts	Pos
1	Jacob CARTY	Brown	Munster Judo Club	XX			0	0	3
2	Kale HARVEY	Shodan	York Judo & BJJ	5	XX		1	0	2
3	Artur TARGOSINSKI	Nidan	Full Circle Judo Club	10	5	XX	2	15	1

## Pool A

Match	White/Blanc	Blue/Bleu	Res/Rés	Tim/Tmp	Code
A-2	Jacob CARTY	1 2 <del>Kale HARVEY</del>	0 - 5	4:00	WAZ
A-10	Jacob CARTY	1 3 <b>Artur TARGOSINSKI</b>	0 - 10	2:02	IPO
A-13	<del>Kale HARVEY</del>	2 3 <b>Artur TARGOSINSKI</b>	0 - 5	4:00	WAZ

## Competitors/Compétiteurs B

#	Name/Nom	Grade	Club	4	5	6	W/G	Pts	Pos
4	Alessandro ZATTIERO	Sandan	Annex Judo Academy	XX		5	1	5	2
5	<del>Patrick BROPHY</del>	Green	York Judo & BJJ	10	XX	10	2	20	1
6	Scott MACDONALD	Brown	Jackpine Judo Club			XX	0	0	3

## Pool B

Match	White/Blanc	Blue/Bleu	Res/Rés	Tim/Tmp	Code
A-5	Alessandro ZATTIERO	4 5 <del>Patrick BROPHY</del>	0 - 10	0:32	IPO
A-11	<b>Alessandro ZATTIERO</b>	4 6 Scott MACDONALD	5 - 0	4:00	WAZ
A-14	<del>Patrick BROPHY</del>	5 6 Scott MACDONALD	10 - 0	0:50	IPO

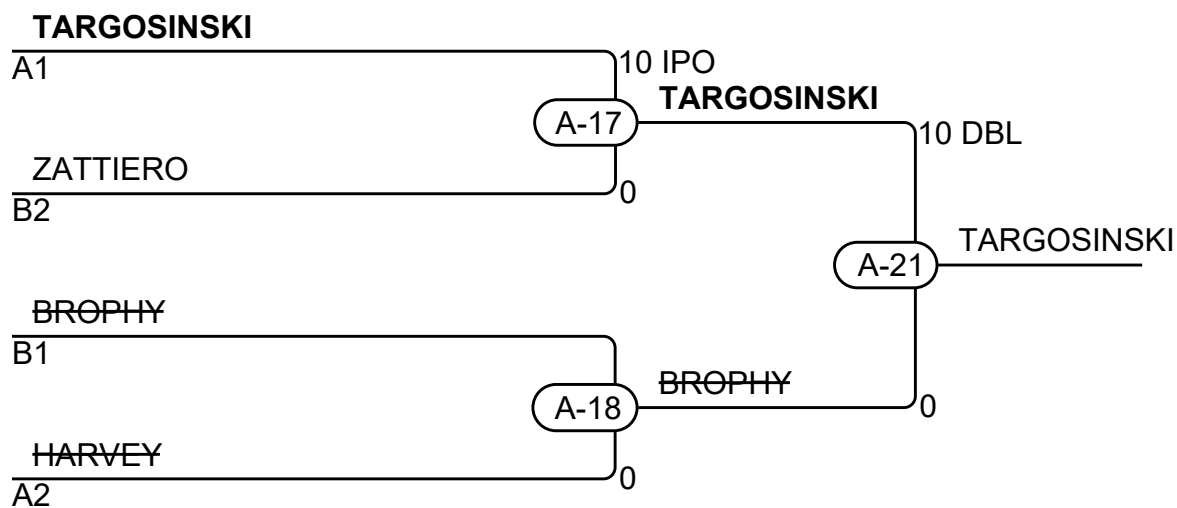

## Results/Résultats

Pos	Name/Nom
1	Artur TARGOSINSKI, Full Circle Judo Club
2	
3	Alessandro ZATTIERO, Annex Judo Academy
3	



# Veteran Ne Waza Men +100kg

## Competitors/Compétiteurs

#	Name/Nom	Grade	Club	1	2	1	2	1	2	W/G	Pts	Pos
1	Larry FRANCIS	Brown	Trent Judo Club	XX		XX		XX		0	0	2
2	Jeff ALLEN	Shodan	Huntsville Judo Club	10	XX	10	XX		XX	2	20	1

## Matches/Matches

Match	White/Blanc			Blue/Bleu	Res/Rés	Tim/Tmp	Code
A-1	Larry FRANCIS	1	2	Jeff ALLEN	0 - 10	0:00	FUS
A-7	Jeff ALLEN	2	1	Larry FRANCIS	10 - 0	0:00	FUS
A-15	Larry FRANCIS	1	2	Jeff ALLEN			

## Results/Résultats

Pos	Name/Nom
1	Jeff ALLEN, Huntsville Judo Club

# Veteran NeWaza Women -52kg

## Competitors/Compétiteurs

#	Name/Nom	Grade	Club	1	2	1	2	1	2	W/G	Pts	Pos
1	Monique TIE	Brown	Club de Judo de l'Univer	XX	10	XX	10	XX		2	20	1
2	Sari LIEM	Blue	York Judo & BJJ		XX		XX		XX	0	0	2

## Matches/Matches

Match	White/Blanc			Blue/Bleu	Res/Rés	Tim/Tmp	Code
A-6	<b>Monique TIE</b>	1	2	Sari LIEM	10 - 0	3:03	IPO
A-12	Sari LIEM	2	1	<b>Monique TIE</b>	0 - 10	1:02	IPO
A-16	Monique TIE	1	2	Sari LIEM			

## Results/Résultats

Pos	Name/Nom
1	Monique TIE, Club de Judo de l'Université d

# Veteran NeWaza Women -70kg

## Competitors/Compétiteurs

#	Name/Nom	Grade	Club	1	2	1	2	1	2	W/G	Pts	Pos
1	Ashley KASURAK	Brown	Sheffield Judo Club	XX	5	XX		XX		1	5	2
2	Viviana AHUMADA	Brown	Annex Judo Academy		XX	5	XX	5	XX	2	10	1

## Matches/Matches

Match	White/Blanc			Blue/Bleu	Res/Rés	Tim/Tmp	Code
B-1	<b>Ashley KASURAK</b>	1	2	Viviana AHUMADA	5 - 0	4:00	WAZ
B-7	<b>Viviana AHUMADA</b>	2	1	Ashley KASURAK	5 - 0	4:00	WAZ
B-13	Ashley KASURAK	1	2	<b>Viviana AHUMADA</b>	0 - 5	4:00	WAZ

## Results/Résultats

Pos	Name/Nom
1	Viviana AHUMADA, Annex Judo Academy
2	Ashley KASURAK, Sheffield Judo Club



# Veteran NeWaza Women +70kg



## Competitors/Compétiteurs

#	Name/Nom	Grade	Club	1	W/G	Pts	Pos
1	Robyn ELLIOTT	Brown	Cloverdale Judo Club	XX	0	0	1

## Matches/Matches

Match	White/Blanc	Blue/Bleu	Res/Rés	Tim/Tmp	Code
-------	-------------	-----------	---------	---------	------

## Results/Résultats

Pos	Name/Nom

# Veteran Women -52kg

## Competitors/Compétiteurs

#	Name/Nom	Grade	Club	1	2	3	W/G	Pts	Pos
1	Sari LIEM	Blue	York Judo & BJJ	XX			0	0	3
2	Alison ROBERTSHAW	Shodan	Full Circle Judo Club	10	XX		1	10	2
3	Monique TIE	Brown	Club de Judo de l'Univer	10	10	XX	2	20	1

## Matches/Matches

Match	White/Blanc			Blue/Bleu	Res/Rés	Tim/Tmp	Code
E-18	Sari LIEM	1	2	Alison ROBERTSHAW	0 - 10	2:24	WIP
E-23	Sari LIEM	1	3	Monique TIE	0 - 10	0:16	IPO
E-29	Alison ROBERTSHAW	2	3	Monique TIE	0 - 10	0:51	IPO

## Results/Résultats

Pos	Name/Nom
1	Monique TIE, Club de Judo de l'Université d
2	Alison ROBERTSHAW, Full Circle Judo Club

# Veteran Women -78kg

## Competitors/Compétiteurs

#	Name/Nom	Grade	Club	1	2	1	2	1	2	W/G	Pts	Pos
1	Robyn ELLIOTT	Brown	Cloverdale Judo Club	XX		XX	10	XX	10	2	20	1
2	Ashley KASURAK	Brown	Sheffield Judo Club	10	XX		XX		XX	1	10	2

## Matches/Matches

Match	White/Blanc			Blue/Bleu	Res/Rés	Tim/Tmp	Code
C-18	Robyn ELLIOTT	1	2	Ashley KASURAK	0 - 10	1:00	IPO
C-26	Ashley KASURAK	2	1	Robyn ELLIOTT	0 - 10	1:18	IPO
C-32	Robyn ELLIOTT	1	2	Ashley KASURAK	10 - 0	1:01	WIP

## Results/Résultats

Pos	Name/Nom
1	Robyn ELLIOTT, Cloverdale Judo Club
2	Ashley KASURAK, Sheffield Judo Club