

SenF -52

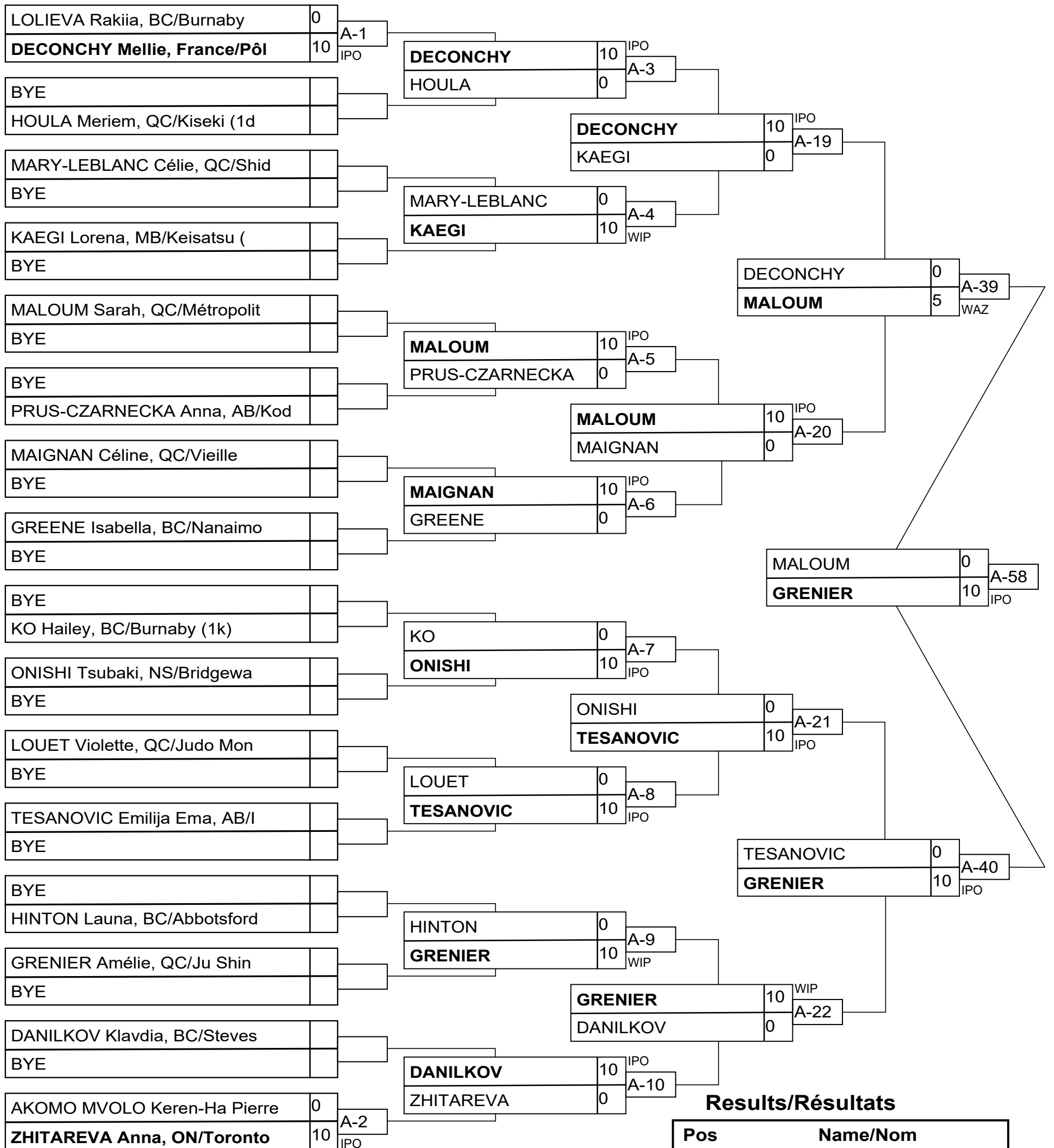

Results/Résultats

| Pos | Name/Nom |
|-----|--------------------------|
| 1 | GRENIER Amélie, QC/Ju Sh |
| 2 | MALOUM Sarah, QC/Métropo |
| 3 | DECONCHY Mellie, France/ |
| 3 | TESANOVIC Emilija Ema, A |

SenF -57

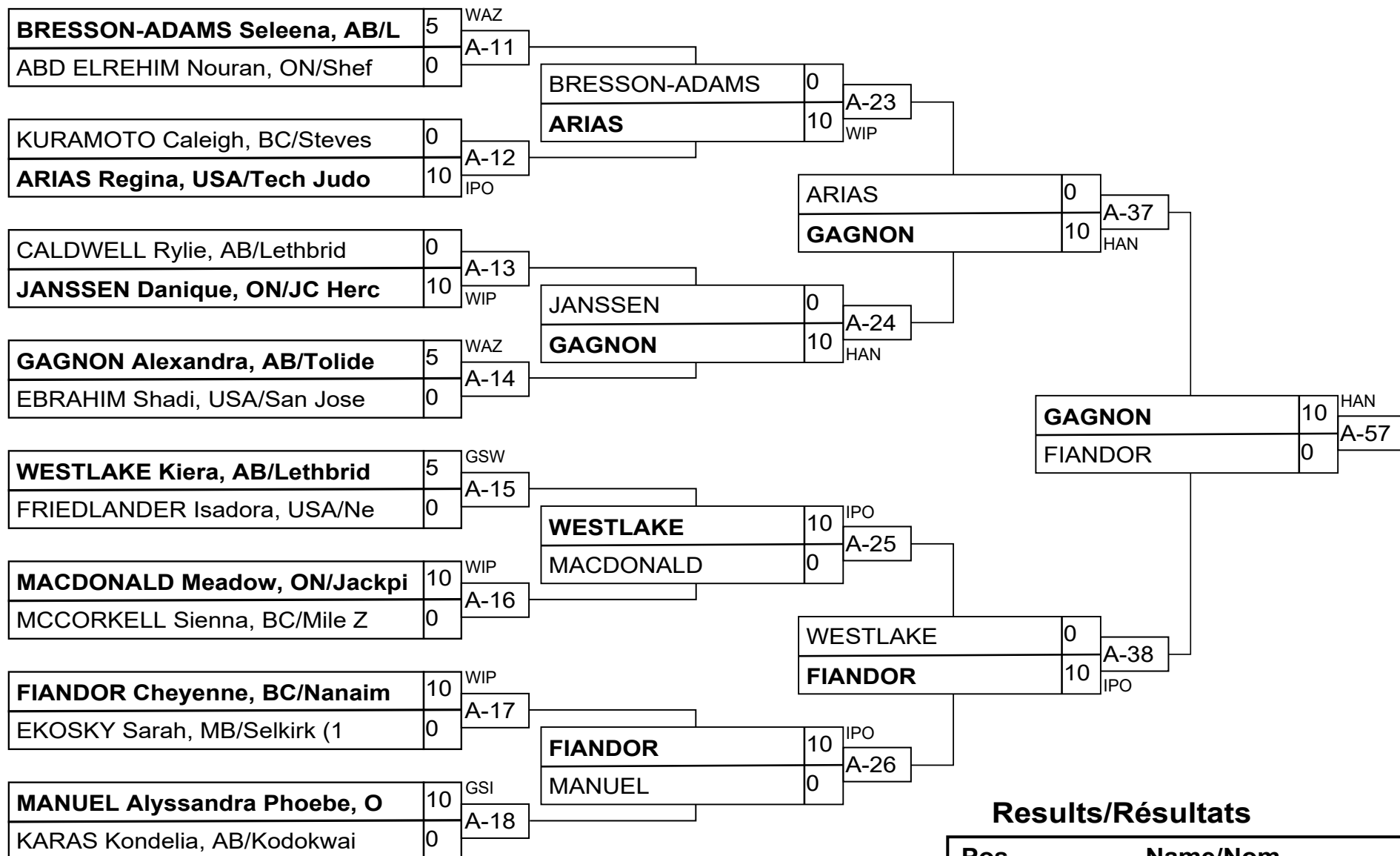

Results/Résultats

| Pos | Name/Nom |
|-----|--------------------------|
| 1 | GAGNON Alexandra, AB/Tol |
| 2 | FIANDOR Cheyenne, BC/Nan |
| 3 | EBRAHIM Shadi, USA/San J |
| 3 | FRIEDLANDER Isadora, USA |

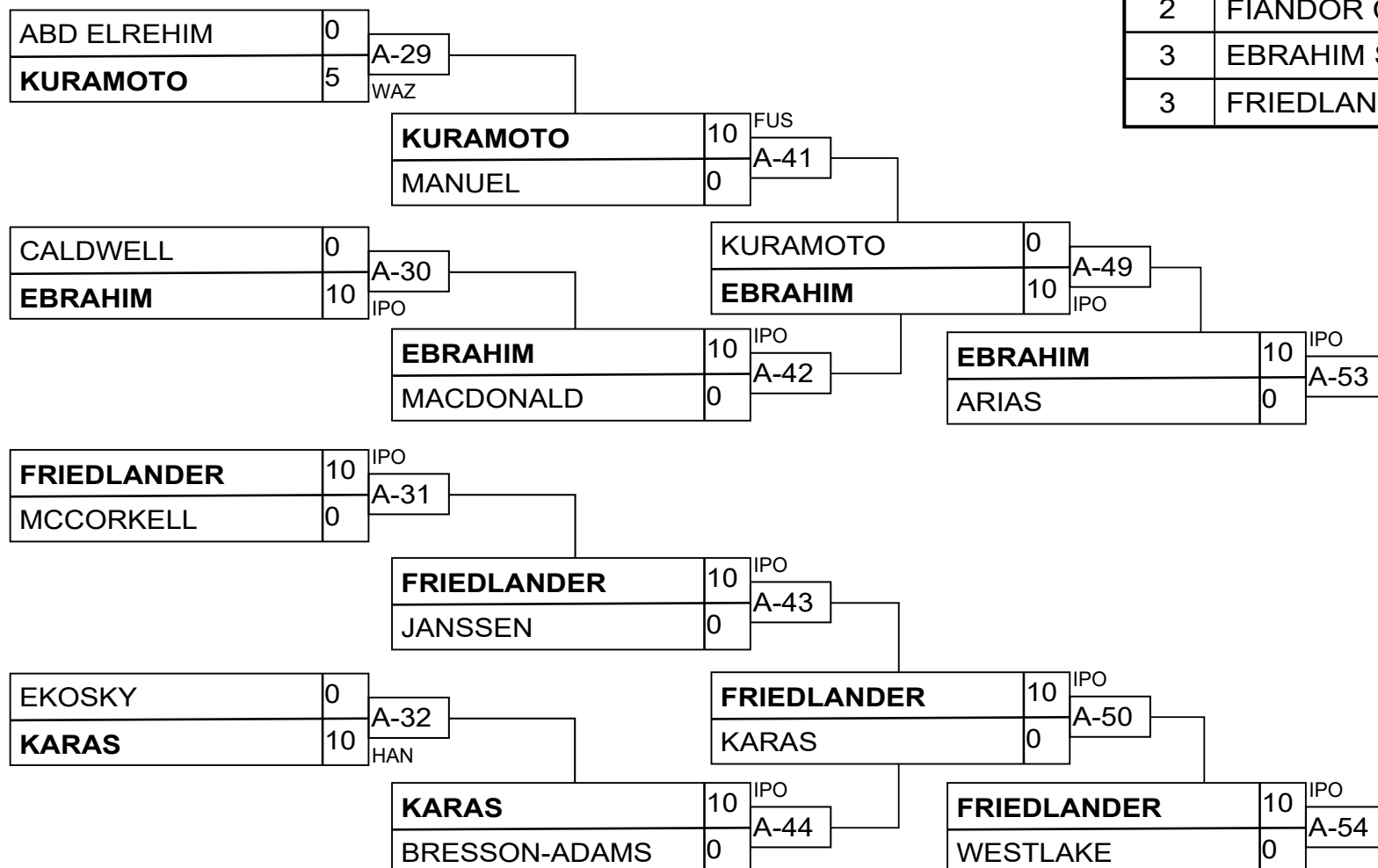

SenF -63

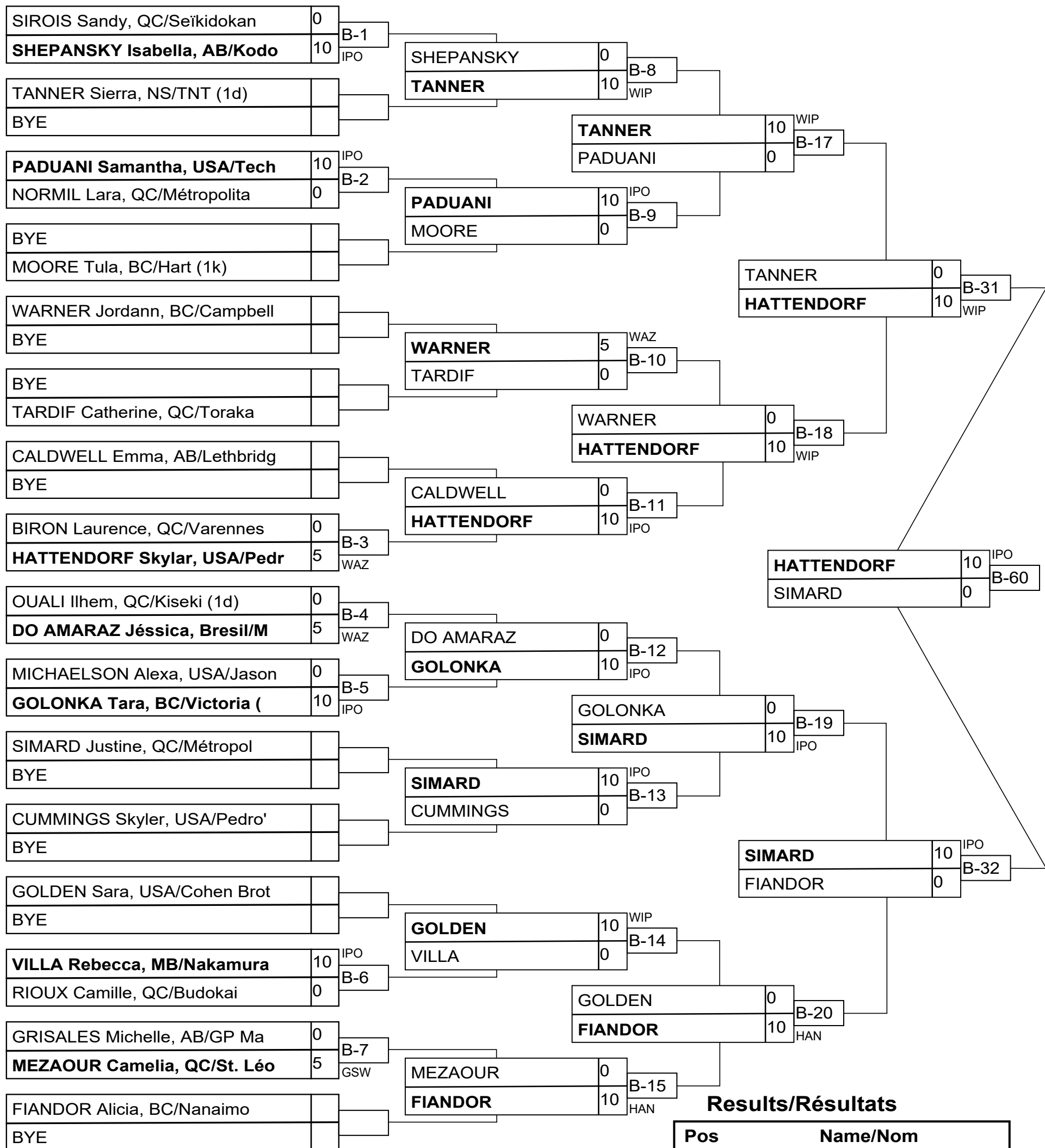

SenF -63

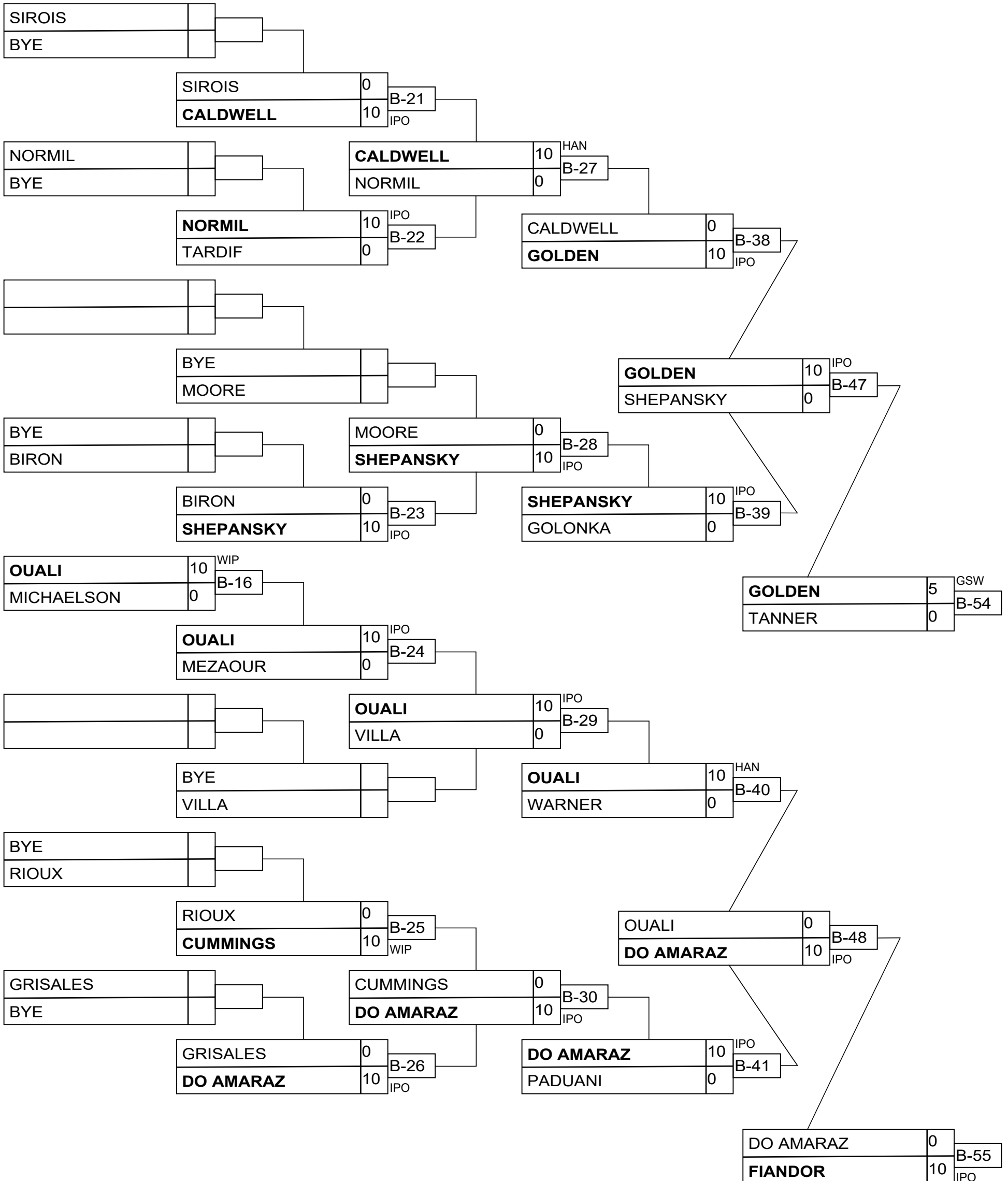

SenF -78

Competitors/Compétiteurs A

| # | Name/Nom | Grade | Club | 1 | 2 | 3 | W/G | Pts | Pos |
|---|--------------------------|-------|---------------|----|----|----|-----|-----|-----|
| 1 | SOMMERFELD Bishop (0,00) | 1d | SK/Regina Y | XX | | | 0 | 0 | 3 |
| 2 | GRONEN Shianne (0,00) | 1d | AB/Lethbridge | 10 | XX | 10 | 2 | 20 | 1 |
| 3 | SYNOTT Josie-Anne (0,00) | 1d | QC/Sept-Iles | 10 | | XX | 1 | 10 | 2 |

Matches/Matches A

| Match | White/Blanc | Blue/Bleu | Res/Rés | Tim/Tmp | Code |
|-------|--------------------------|-------------------|---------|---------|------|
| B-36 | SOMMERFELD Bishop 1 2 | GRONEN Shianne | 0 - 10 | 2:33 | IPO |
| B-45 | SOMMERFELD Bishop 1 3 | SYNOTT Josie-Anne | 0 - 10 | 2:45 | IPO |
| B-52 | GRONEN Shianne 2 3 | SYNOTT Josie-Anne | 10 - 0 | 0:13 | IPO |

Competitors/Compétiteurs B

| # | Name/Nom | Grade | Club | 4 | 5 | 6 | W/G | Pts | Pos |
|---|-------------------------|-------|---------------------|----|----|----|-----|-----|-----|
| 4 | STOUT Nicole (0,00) | 1d | USA/Jason Morris | XX | | 10 | 1 | 10 | 2 |
| 5 | GODBOUT Coralie (0,00) | 1d | QC/Vieille Capitale | 10 | XX | 10 | 2 | 20 | 1 |
| 6 | DARLOW Annabelle (0,00) | 1d | AB/Lethbridge | | | XX | 0 | 0 | 3 |

Matches/Matches B

| Match | White/Blanc | Blue/Bleu | Res/Rés | Tim/Tmp | Code |
|-------|------------------------|------------------|---------|---------|------|
| B-37 | STOUT Nicole 4 5 | GODBOUT Coralie | 0 - 10 | 1:53 | WIP |
| B-46 | STOUT Nicole 4 6 | DARLOW Annabelle | 10 - 0 | 0:15 | IPO |
| B-53 | GODBOUT Coralie 5 6 | DARLOW Annabelle | 10 - 0 | 2:21 | IPO |

GRONEN

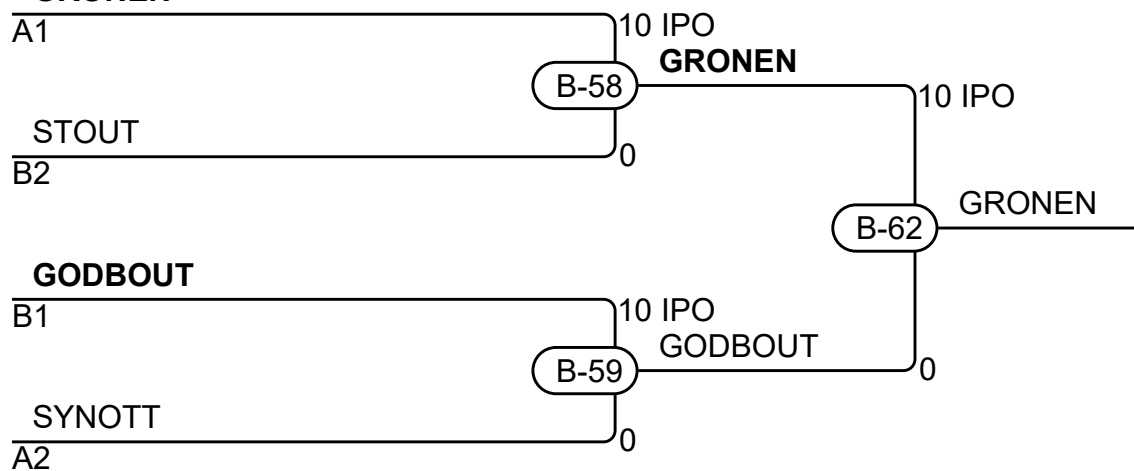

Results/Résultats

| Pos | Name/Nom |
|-----|--------------------------------------|
| 1 | GRONEN Shianne, AB/Lethbridge |
| 2 | GODBOUT Coralie, QC/Vieille Capitale |
| 3 | STOUT Nicole, USA/Jason Morris |
| 3 | SYNOTT Josie-Anne, QC/Sept-Iles |

SenM -100

Competitors/Compétiteurs A

| # | Name/Nom | Grade | Club | 1 | 2 | 3 | 4 | W/G | Pts | Pos |
|---|-------------------------|-------|----------------------|----|----|----|----|-----|-----|-----|
| 1 | ROBIN Alexis (0,00) | 1d | QC/Olympique | XX | 10 | 10 | 10 | 3 | 30 | 1 |
| 2 | CHAMPAGNE Jérôme (0,00) | 1k | QC/Varenes | | XX | | 10 | 1 | 10 | 3 |
| 3 | HURST Matt (0,00) | 1d | NB/Dragons Judo Club | | 10 | XX | 10 | 2 | 20 | 2 |
| 4 | DORE Nicholas (0,00) | 1d | ON/Takahashi | | | | XX | 0 | 0 | 4 |

Matches/Matches A

| Match | White/Blanc | Blue/Bleu | Res/Rés | Tim/Tmp | Code |
|-------|------------------|----------------------|---------|---------|------|
| B-33 | ROBIN Alexis | 1 2 CHAMPAGNE Jérôme | 10 - 0 | 4:41 | IPO |
| B-34 | HURST Matt | 3 4 DORE Nicholas | 10 - 0 | 1:30 | WIP |
| B-42 | ROBIN Alexis | 1 3 HURST Matt | 10 - 0 | 0:54 | IPO |
| B-43 | CHAMPAGNE Jérôme | 2 4 DORE Nicholas | 10 - 0 | 2:50 | HAN |
| B-49 | ROBIN Alexis | 1 4 DORE Nicholas | 10 - 0 | 0:22 | IPO |
| B-50 | CHAMPAGNE Jérôme | 2 3 HURST Matt | 0 - 10 | 0:25 | IPO |

Competitors/Compétiteurs B

| # | Name/Nom | Grade | Club | 5 | 6 | 7 | W/G | Pts | Pos |
|---|-------------------------|-------|--------------|----|----|----|-----|-----|-----|
| 5 | BOARO Kristopher (0,00) | 1d | ON/North Bay | XX | | | 0 | 0 | 3 |
| 6 | MARCONNET Yohann (0,00) | 1d | QC/Jikan | 10 | XX | 10 | 2 | 20 | 1 |
| 7 | ST LOUIS Terry (0,00) | 1k | ON/Sho Jin | 10 | | XX | 1 | 10 | 2 |

Matches/Matches B

| Match | White/Blanc | Blue/Bleu | Res/Rés | Tim/Tmp | Code |
|-------|------------------|----------------------|---------|---------|------|
| B-35 | BOARO Kristopher | 5 6 MARCONNET Yohann | 0 - 10 | 0:00 | FUS |
| B-44 | BOARO Kristopher | 5 7 ST LOUIS Terry | 0 - 10 | 0:00 | FUS |
| B-51 | MARCONNET Yohann | 6 7 ST LOUIS Terry | 10 - 0 | 0:54 | IPO |

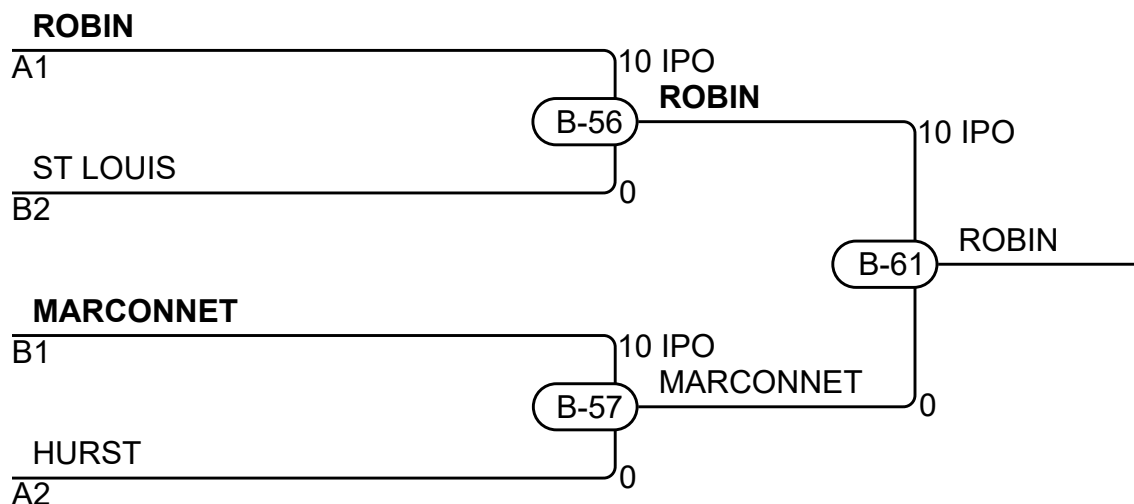

Results/Résultats

| Pos | Name/Nom |
|-----|----------------------------------|
| 1 | ROBIN Alexis, QC/Olympique |
| 2 | MARCONNET Yohann, QC/Jikan |
| 3 | ST LOUIS Terry, ON/Sho Jin |
| 3 | HURST Matt, NB/Dragons Judo Club |

SenM -66

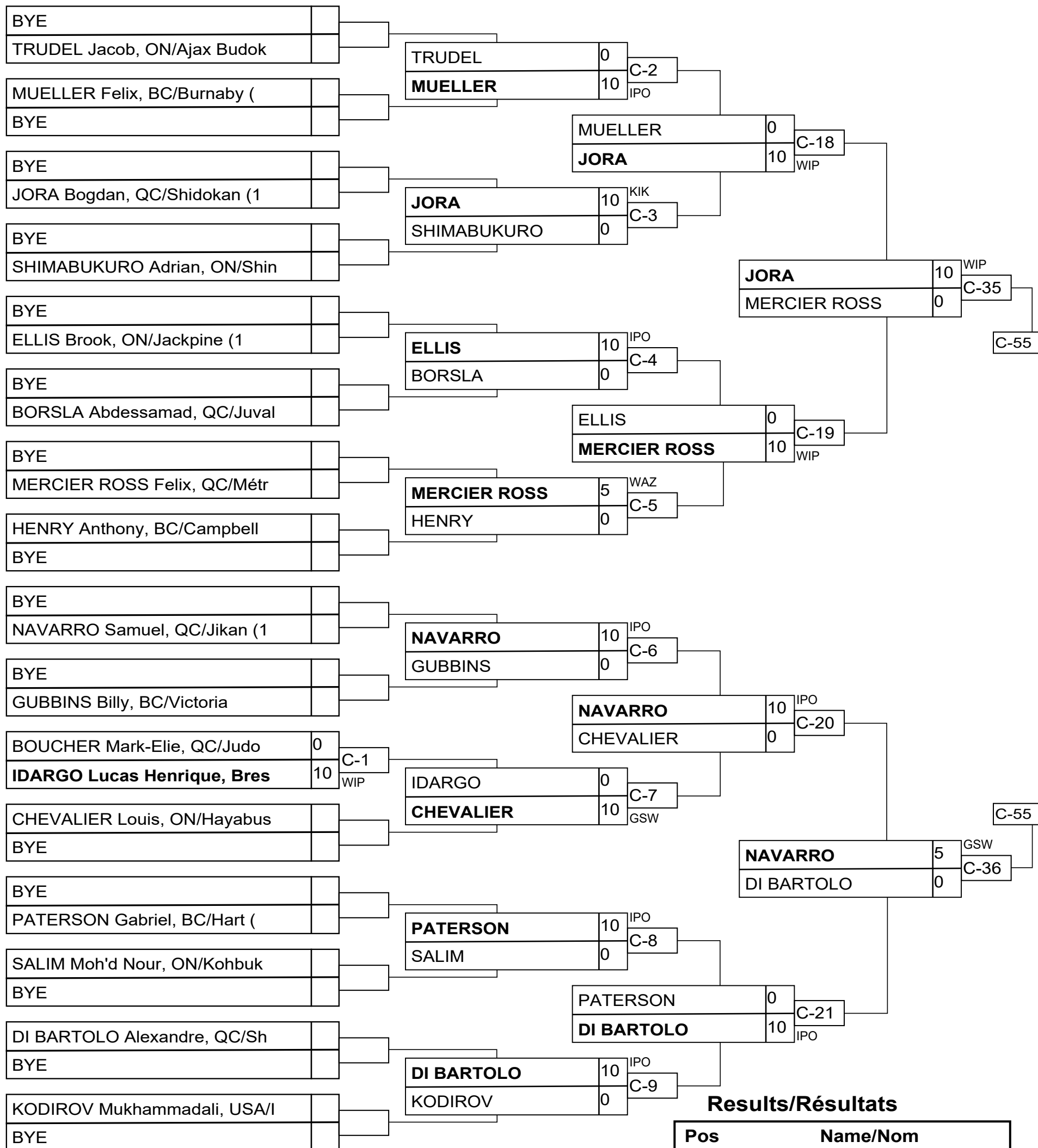

SenM -66

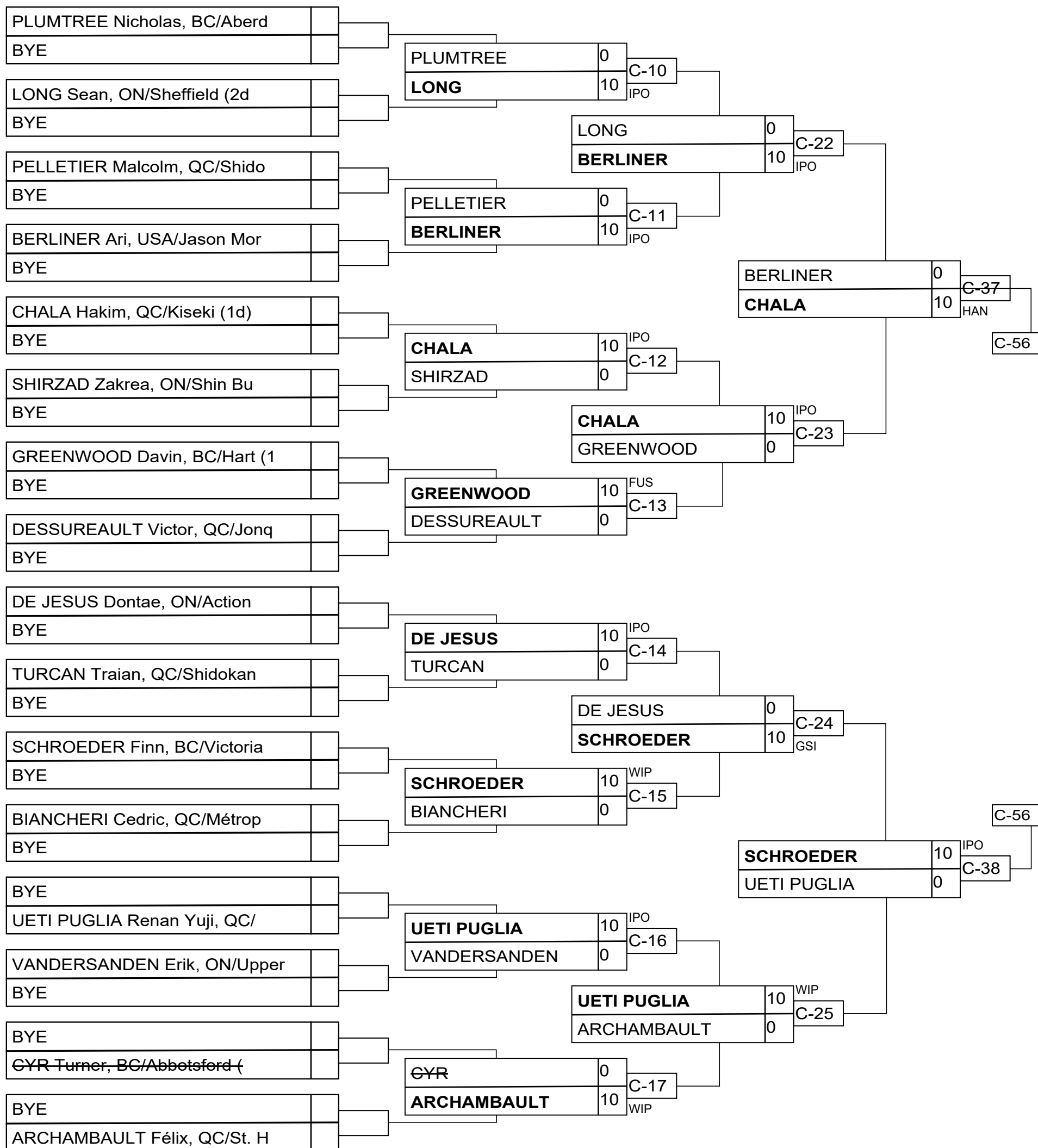

SenM -66

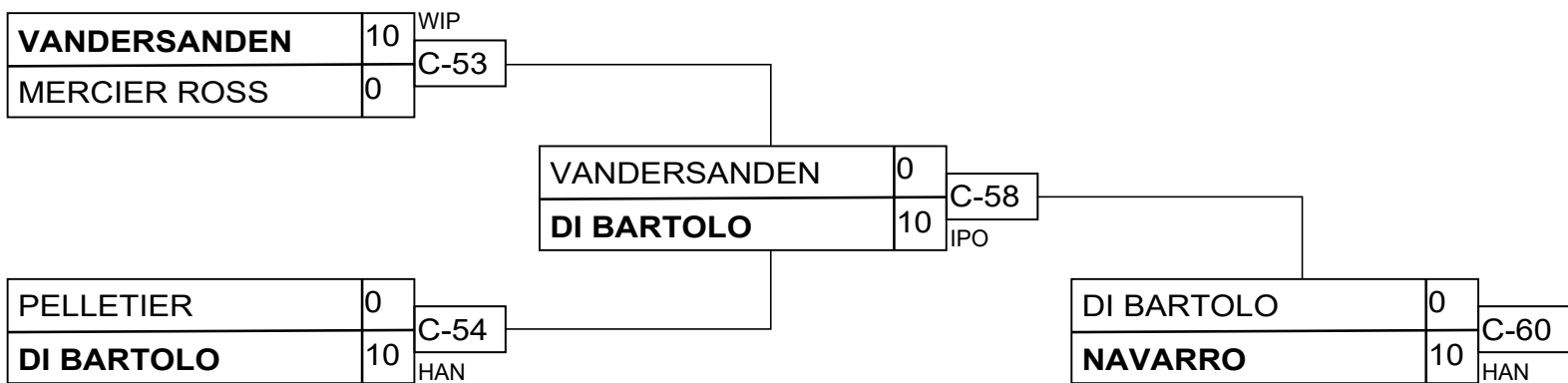
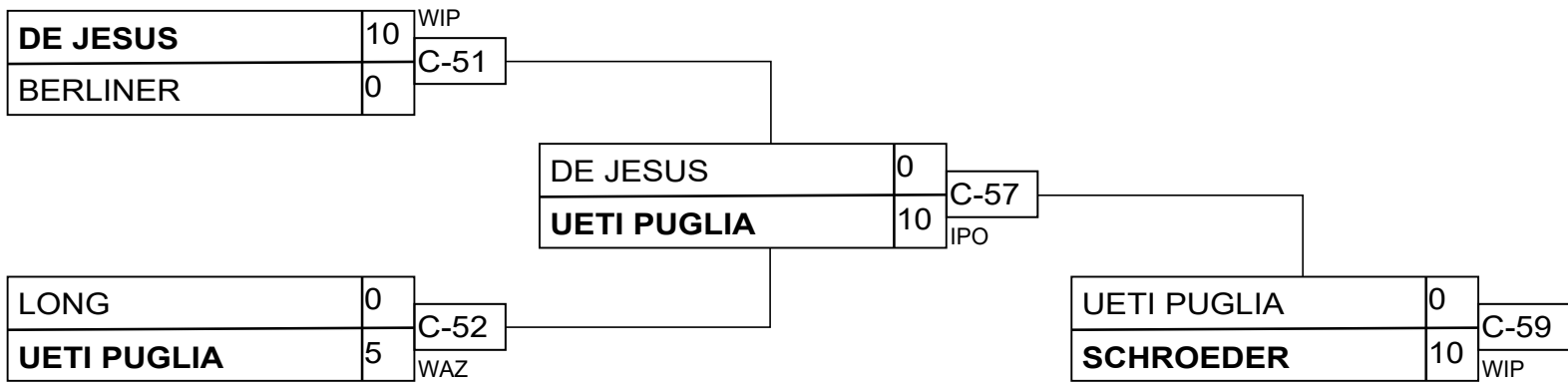
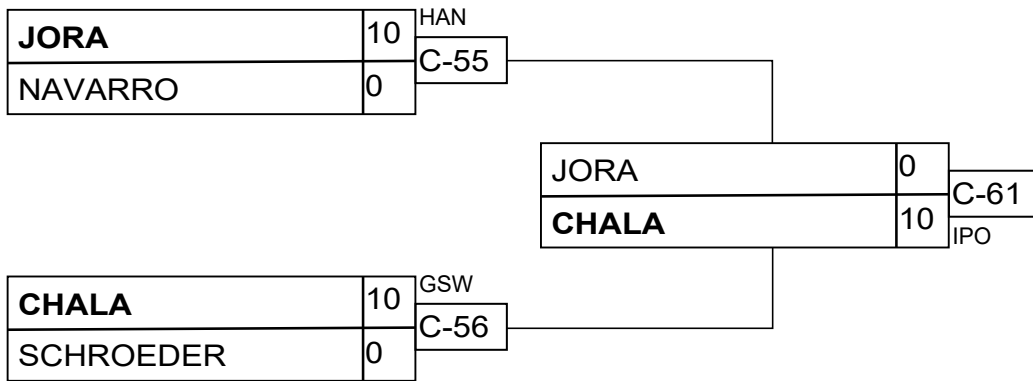

SenM -73

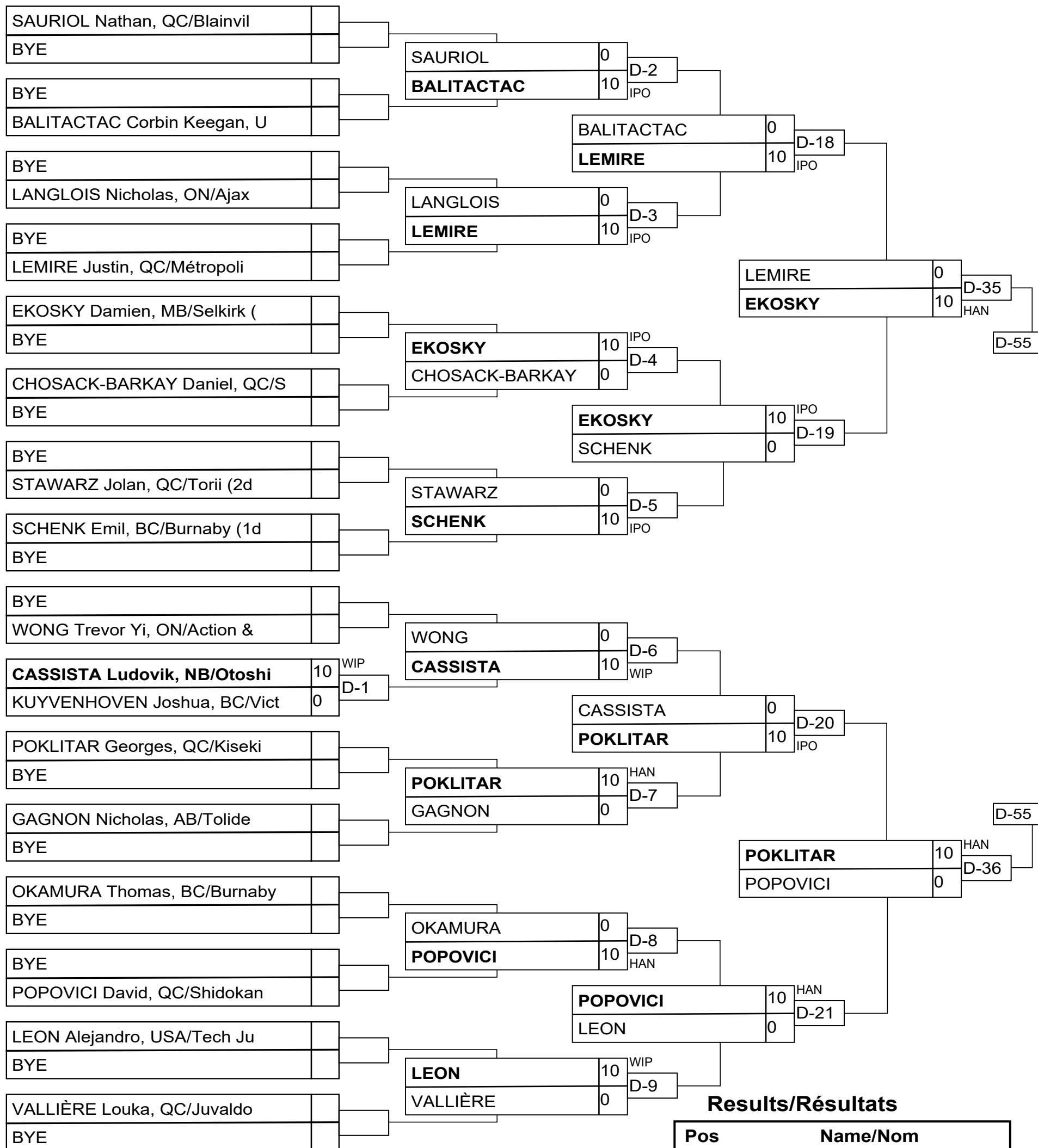

Results/Résultats

| Pos | Name/Nom |
|-----|--------------------------|
| 1 | JUTEAU Gabriel, QC/Bouch |
| 2 | POKLITAR Georges, QC/Kis |
| 3 | VACC Gabriel, QC/Olympiq |
| 3 | EKOSKY Damien, MB/Selkir |

SenM -73

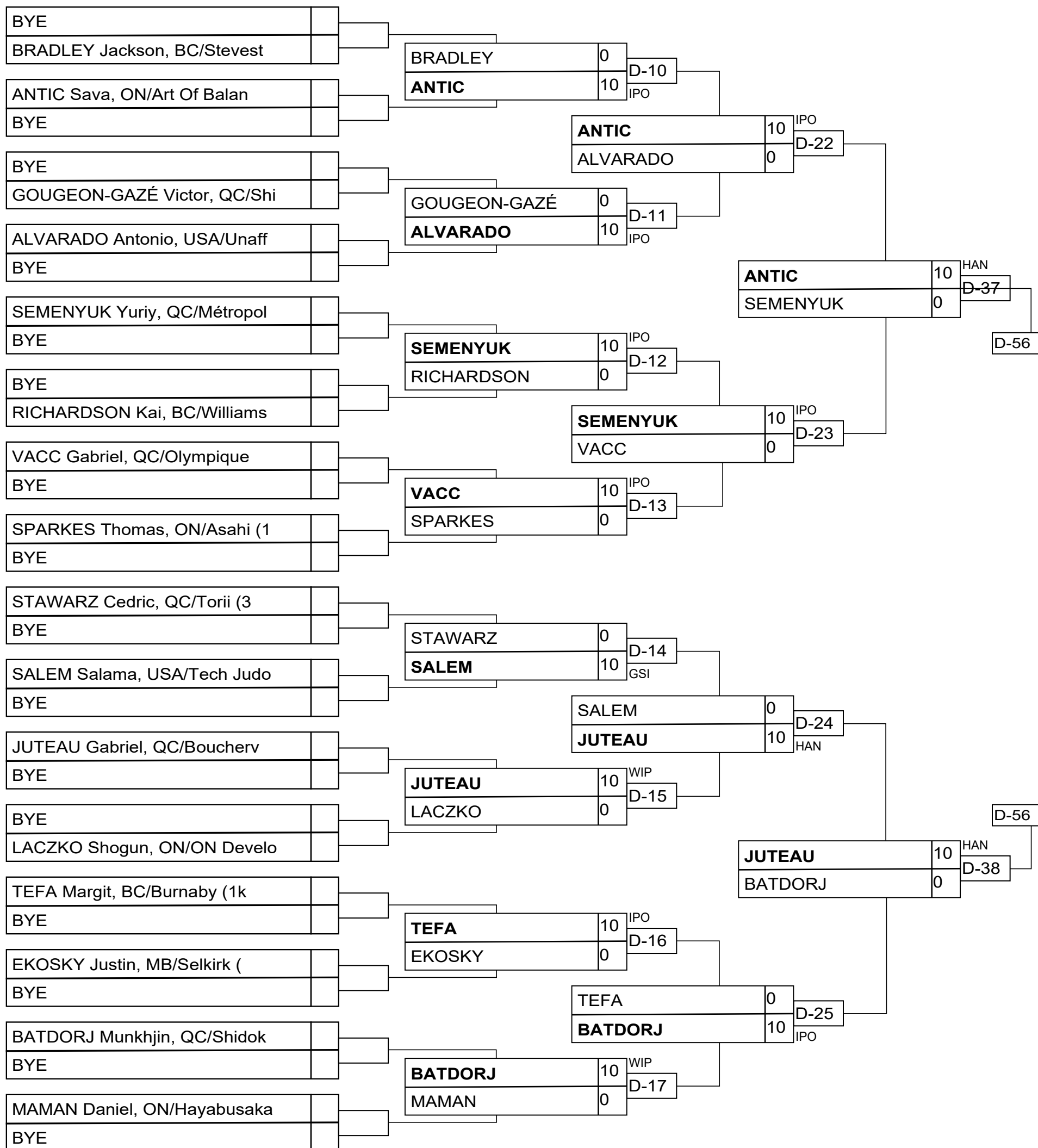

SenM -73

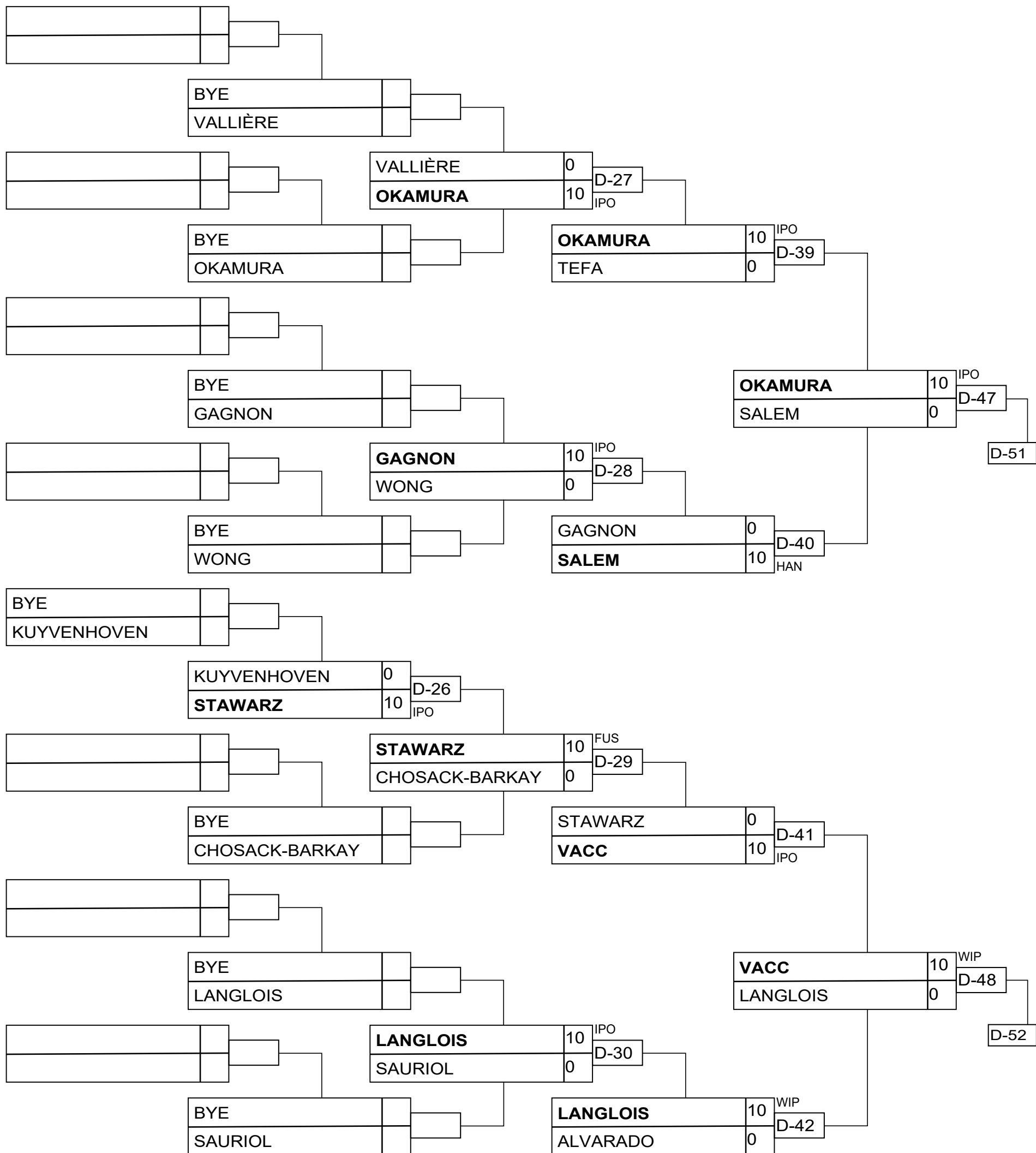

SenM -73

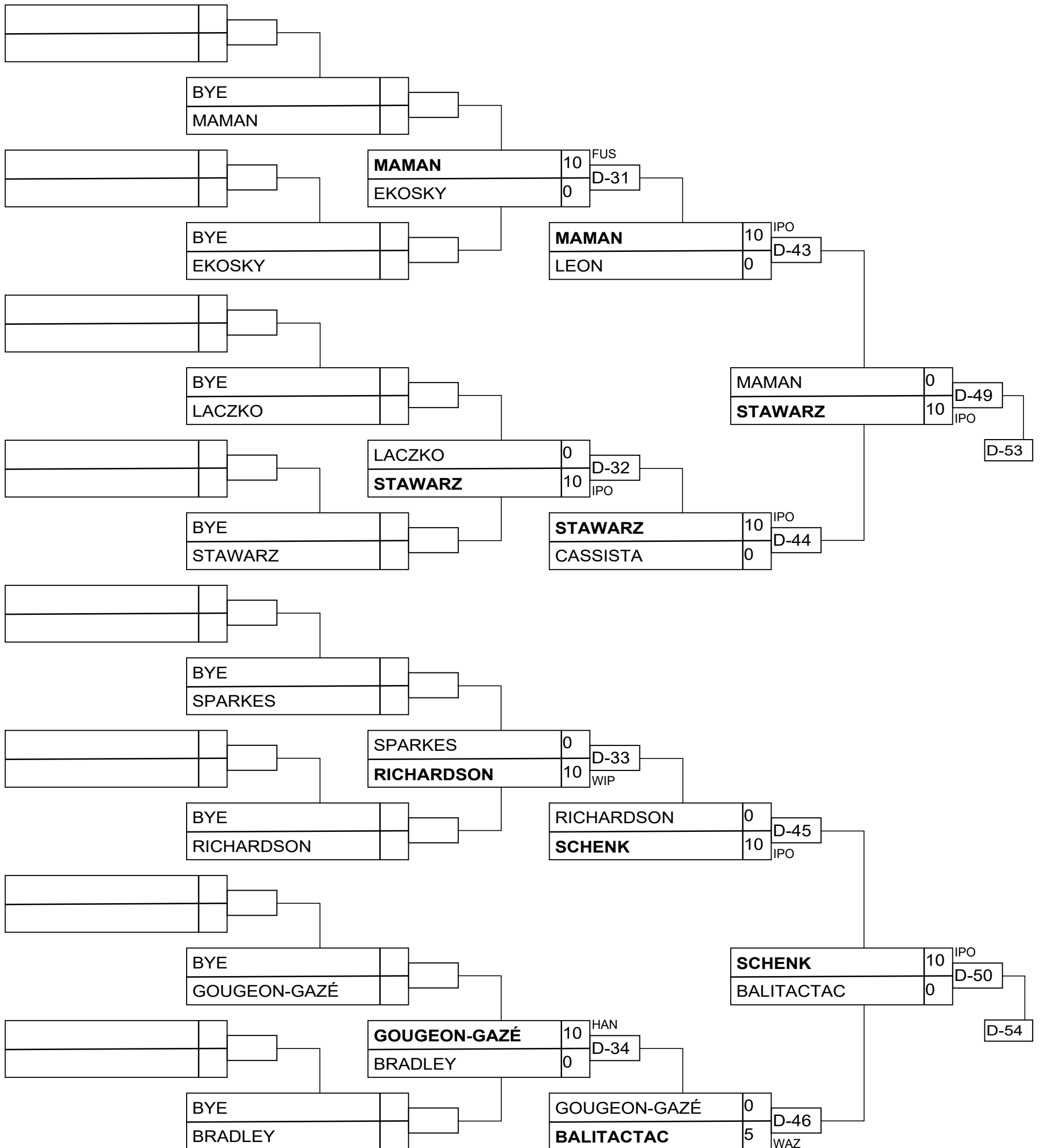

SenM -73

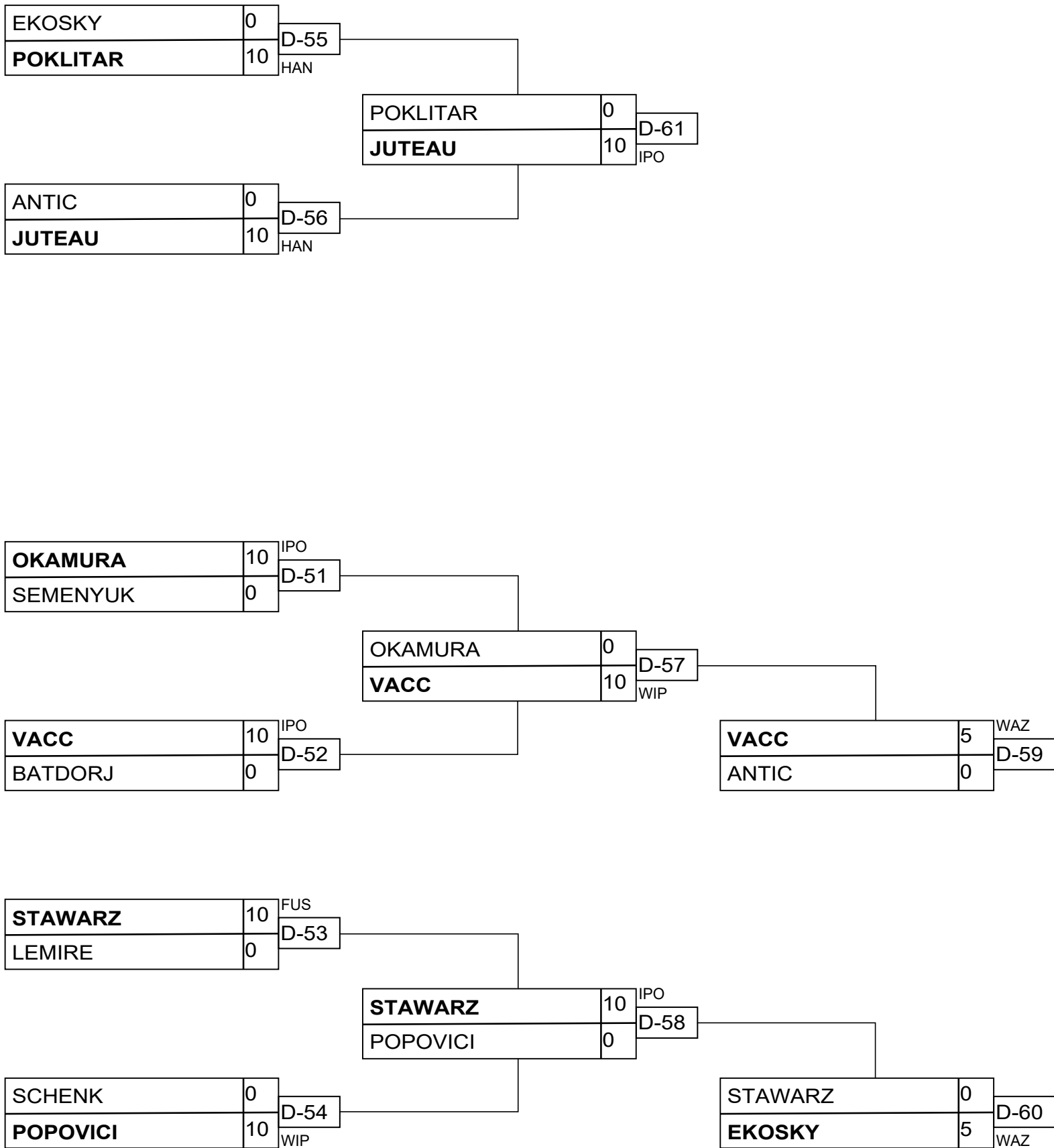

TT SenM -100

Competitors/Compétiteurs

| # | Name/Nom | Grade | Club | 1 | 2 | 3 | W/G | Pts | Pos |
|---|-------------------------|-------|----------------------|----|----|----|-----|-----|-----|
| 1 | ROBIN Alexis (0,00) | 1d | QC/Olympique | XX | 10 | 10 | 2 | 20 | 1 |
| 2 | CHAMPAGNE Jérôme (0,00) | 1k | QC/Varennnes | | XX | | 0 | 0 | 3 |
| 3 | HURST Matt (0,00) | 1d | NB/Dragons Judo Club | | 10 | XX | 1 | 10 | 2 |

Matches/Matches

| Match | White/Blanc | | | Blue/Bleu | Res/Rés | Tim/Tmp | Code |
|-------|---------------------|---|---|-------------------|---------|---------|------|
| B-53A | ROBIN Alexis | 1 | 2 | CHAMPAGNE Jérôme | 10 - 0 | 2:40 | GSI |
| B-58A | ROBIN Alexis | 1 | 3 | HURST Matt | 10 - 0 | 1:13 | IPO |
| B-60 | CHAMPAGNE Jérôme | 2 | 3 | HURST Matt | 0 - 10 | 0:17 | GSI |

Results/Résultats

| Pos | Name/Nom |
|-----|----------------------------------|
| 1 | ROBIN Alexis, QC/Olympique |
| 2 | HURST Matt, NB/Dragons Judo Club |
| | |